

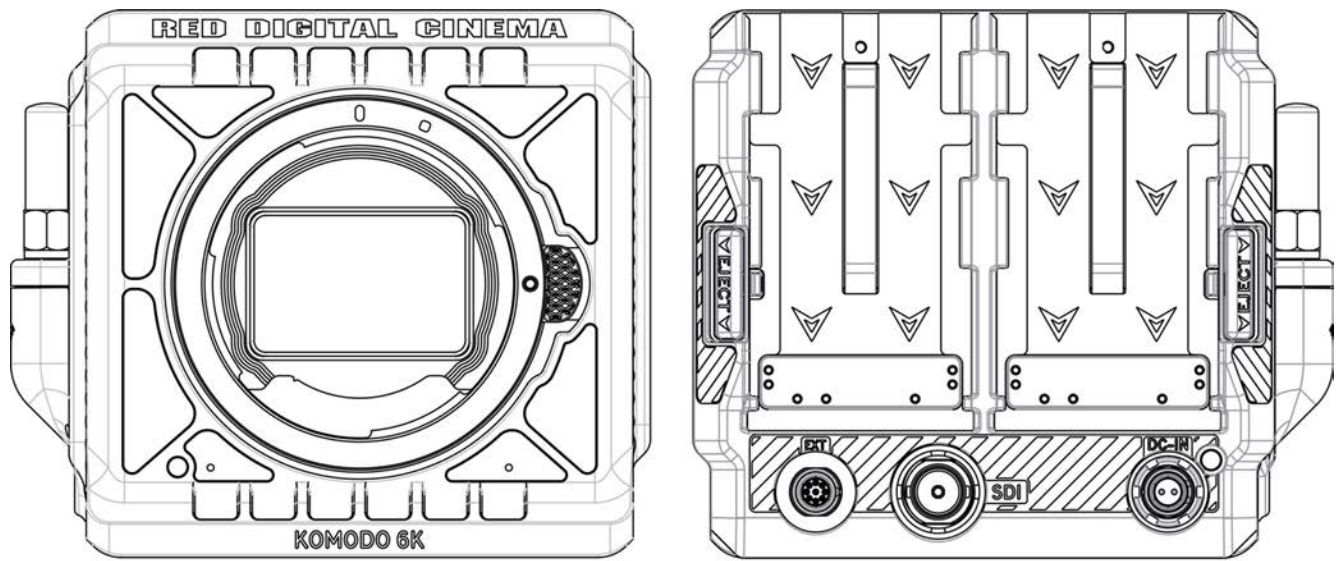

# KOMODO®

## OPERATION GUIDE

---



---

KOMODO 6K S35 | V1.6

[RED.COM](http://RED.COM)

# TABLE OF CONTENTS

<b>DISCLAIMER</b> .....	<b>IV</b>	<b>PROJECT SETTINGS MENU</b> .....	<b>64</b>
<b>SAFETY INSTRUCTIONS</b> .....	<b>VI</b>	FORMAT .....	65
<b>1. INTRODUCTION</b>		RECORDING FRAME RATE .....	69
KOMODO .....	1	PROJECT TIME BASE .....	70
<b>2. QUICK REFERENCE</b>		FILE FORMAT .....	70
PREPARING THE CAMERA HARDWARE .....	4	R3D QUALITY .....	73
PREPARING THE CAMERA SYSTEM .....	4	PRORES RESOLUTION .....	73
CONFIGURING THE SETTINGS .....	4	PRORES CODEC .....	74
RECORDING .....	4	PRORES COLOR PROFILE .....	74
PROCESSING FOOTAGE .....	4	PRE-RECORD .....	75
<b>3. CAMERA COMPONENTS</b>		RECORDING MODE .....	76
CAMERA BODY .....	5	TIMELAPSE .....	77
CAMERA BODY CONTROLS AND FEATURES .....	5	FRAME LIMIT .....	78
FRONT .....	5	SLATE .....	79
TOP .....	6	<b>AUDIO / TC MENU</b> .....	<b>81</b>
LEFT .....	7	AUDIO SOURCE .....	83
RIGHT .....	8	INTERNAL MICROPHONE .....	84
BACK .....	9	EXTERNAL AUDIO .....	85
BOTTOM .....	10	HEADPHONE .....	86
CAMERA BODY LEDS .....	11	TIMECODE SOURCE .....	87
<b>BATTERIES</b> .....	<b>15</b>	TIMECODE DISPLAY MODE .....	87
REDVOLT BP .....	15	<b>MONITORING MENU</b> .....	<b>88</b>
CANON BP-955 .....	16	LCD .....	89
CANON BP-975 .....	16	SDI .....	91
<b>LENSES AND ADAPTORS</b> .....	<b>17</b>	LIVE STREAM .....	97
COMPATIBLE LENSES .....	18	TOOLS .....	98
COMPATIBLE MOUNT ADAPTORS .....	18	GUIDES .....	105
ATTACHING LENSES .....	18	<b>MEDIA MENU</b> .....	<b>113</b>
REMOVING LENSES .....	18	EJECT .....	113
<b>RED CFAST 2.0 READER</b> .....	<b>19</b>	MEDIA INFO .....	114
<b>KOMODO EXPANDER MODULE</b> .....	<b>19</b>	SECURE FORMAT .....	114
<b>KOMODO LINK ADAPTOR</b> .....	<b>20</b>	<b>PRESETS MENU</b> .....	<b>118</b>
<b>KOMODO OUTRIGGER HANDLE</b> .....	<b>20</b>	CREATE PRESET .....	118
<b>KOMODO WING GRIP</b> .....	<b>21</b>	ON MEDIA PRESETS .....	120
<b>LCD TOUCHSCREEN</b> .....	<b>21</b>	IN CAMERA PRESETS .....	120
STATUS BAR .....	27	<b>AUTOFOCUS - BETA MENU</b> .....	<b>121</b>
STATUS PAGE .....	31	ENABLE .....	121
MONITORING TOOLS .....	32	MODE .....	122
HISTOGRAM .....	36	SIZE .....	122
AUDIO TOOLS .....	37	POSITION .....	123
PLAYBACK .....	40	<b>COMMUNICATION MENU</b> .....	<b>124</b>
<b>RED CONTROL APP</b> .....	<b>44</b>	CAMERA .....	124
<b>4. MENUS</b>		WI-FI .....	125
<b>IMAGE / LUT MENU</b> .....	<b>46</b>	SERIAL .....	136
ISO .....	47	KOMODO LINK ADAPTOR .....	138
SHUTTER .....	47	FTPS .....	142
WHITE BALANCE .....	49	<b>SYSTEM SETTINGS MENU</b> .....	<b>143</b>
OUTPUT COLOR SPACE .....	52	DATE / TIME .....	144
OUTPUT TONE MAP .....	53	LENS .....	146
HIGHLIGHT ROLL-OFF .....	53	POWER .....	148
DISPLAY PRESET .....	54	INDICATORS .....	149
3D LUT .....	55	GPO FUNCTION .....	151
CDL .....	57	STATUS SETTINGS .....	151
EXPOSURE ADJUST .....	63	SYSTEM STATUS .....	153
		<b>LANGUAGE MENU</b> .....	<b>155</b>

MAINTENANCE MENU .....	155	NETWORK CONFIGURATION .....	204
CALIBRATE .....	156	FTPS CONFIGURATION .....	207
CALIBRATION .....	157	CAMERA SET-UP .....	207
SAVE LOG .....	158	SOFTWARE SET-UP (FILEZILLA) .....	208
RESET DEFAULTS .....	158	ADDITIONAL INFORMATION .....	209
FACTORY RESET .....	159	SYSTEM MAINTENANCE .....	210
UPGRADE .....	159	EXTERIOR SURFACES .....	210
<b>5. HOW TO</b>		STORAGE .....	210
WI-FI CONFIGURATION .....	160	LCD SCREEN .....	211
CONNECTING WIRELESSLY TO AN EXISTING		WATER DAMAGE .....	211
WI-FI NETWORK .....	160	<b>A. TROUBLESHOOTING</b>	
POWER .....	163	GENERAL TROUBLESHOOTING TIPS .....	A
ATTACHING THE BATTERIES .....	163	CONTACT SUPPORT .....	A
REMOVING THE BATTERIES .....	163	STATUS ICONS .....	B
POWER COMPONENTS .....	163	<b>B. MECHANICAL DRAWINGS</b>	
KOMODO POWER ADAPTOR .....	164	FRONT VIEW .....	D
AUTO BOOT ON POWER .....	164	BACK VIEW .....	E
POWER CONSUMPTION .....	164	RIGHT SIDE VIEW .....	E
POWER PRIORITY .....	164	LEFT SIDE VIEW .....	F
TURNING ON THE CAMERA .....	165	TOP VIEW .....	G
TURNING OFF THE CAMERA .....	166	BOTTOM VIEW .....	G
MEDIA MANAGEMENT .....	166	EXTENSION PORT .....	H
EJECTING (UNMOUNTING) MEDIA .....	166	9-PIN 0B ODU AUXILIARY PORT PINOUT .....	H
INSERTING THE MEDIA .....	168	DC-INPUT .....	I
SECURE FORMAT .....	170	SPECIFICATIONS .....	I
MEDIA INFORMATION .....	171	ODU 0B 2-PIN CONNECTOR .....	I
FILE SYSTEM .....	171	CTRL (RS-232 CONTROL) .....	J
CLIP NAMING CONVENTION .....	172	SPECIFICATIONS .....	J
CLIP METADATA .....	172	ODU 00B 4-PIN CONNECTOR .....	J
MEDIA BEST PRACTICES .....	173	<b>C. MENU MAP</b> .....	<b>K</b>
MONITORING .....	174	<b>D. TECHNICAL SPECIFICATIONS</b> .....	<b>M</b>
LCD TOUCHSCREEN .....	174		
SDI OUTPUT TO A MONITOR .....	175		
RED CONTROL .....	177		
KOMODO LINK ADAPTOR .....	178		
EXPOSURE .....	179		
FALSE COLOR EXPOSURE TOOLS .....	181		
FOCUS .....	182		
FOCUS PEAKING MODE .....	182		
EDGE PEAKING MODE .....	182		
PEAKING PEAKING MODE .....	183		
TIMECODE .....	183		
TIME OF DAY .....	183		
EDGECODE .....	185		
ZEBRA MODES .....	186		
ZEBRA OVERVIEW .....	186		
PRE-RECORDING CONTENT .....	187		
CALIBRATING THE SENSOR .....	188		
WHEN TO CALIBRATE SENSOR .....	188		
UPGRADING THE FIRMWARE .....	188		
VERIFYING THE FIRMWARE VERSION .....	188		
UPGRADING THE FIRMWARE .....	188		
KOMODO LINK ADAPTOR .....	191		
ANDROID CONFIGURATION .....	191		
APPLE CONFIGURATION .....	197		

## DISCLAIMER

RED® has made every effort to provide clear and accurate information in this document, which is provided solely for the user's information. While thought to be accurate, the information in this document is provided strictly "as is" and RED will not be held responsible for issues arising from typographical errors or user's interpretation of the language used herein that is different from that intended by RED. All information is subject to change as a result of changes in local, federal or other applicable laws.

RED reserves the right to revise this document and make changes from time to time in the content hereof without obligation to notify any person of such revisions or changes. In no event shall RED, its employees or authorized agents be liable to you for any damages or losses, direct or indirect, arising from the use of any technical or operational information contained in this document.

This document was generated on 2/10/2022. To see earlier versions of this document, submit a Support ticket at <https://support.red.com>. For comments or questions about content in this document, send a detailed email to [OpsGuides@red.com](mailto:OpsGuides@red.com).

## COPYRIGHT NOTICE

COPYRIGHT© 2022 RED.COM, LLC

All trademarks, trade names, logos, icons, images, written material, code, and product names used in association with the accompanying product are the copyrights, trademarks, or other intellectual property owned and controlled exclusively by RED.COM, LLC. For a comprehensive list, see [www.red.com/trademarks](http://www.red.com/trademarks).

## TRADEMARK DISCLAIMER

All other company, brand, and product names are trademarks or registered trademarks of their respective holders. RED has no affiliation to, is not associated with or sponsored by, and has no express rights in third-party trademarks. Adobe and Adobe Premiere Pro are registered trademarks of Adobe Systems Incorporated. AJA is a registered trademark of AJA Video Systems, Inc. Cooke and S4/i are registered trademarks of Cooke Optics Limited. DaVinci is a registered trademark of Blackmagic Design in the U.S. and other countries. Distagon, Makro-Planar, and Otus are registered trademarks of Carl Zeiss AG. Fujinon is a registered trademark of FUJIFILM CORPORATION. HDMI is a registered trademark of HDMI Licensing LLC in the United States and other countries. Leica is a registered trademark of Leica Microsystems. Loctite is a registered trademark of Henkel AG & Company KGaA. Nikkor and Nikon are registered trademarks of Nikon Corporation. Canon is a registered trademark of Canon, U.S.A. Apple, iOS, Macintosh, Final Cut Pro, and QuickTime are registered trademarks of Apple Inc. in the U.S. and other countries. Windex is a registered trademark of S. C. Johnson & Son, Inc. Windows is a registered trademark of Microsoft Corporation. Sony is a registered trademark of Sony Corporation. TORX is a registered trademark of Acument Intellectual Properties, LLC in the United States or other countries. Avid is a registered trademark of Avid Technology, Inc. DaVinci Resolve is a registered trademark of Blackmagic Design in the U.S. and other countries. EDIUS Pro is a registered trademark of Grass Valley. Vegas Pro is a registered trademark of Sony Creative Software. IDX is a registered trademark of IDX Company, Ltd.

## COMPLIANCE STATEMENTS

### INDUSTRIAL CANADA EMISSION COMPLIANCE STATEMENTS

This device complies with Industry Canada license-exempt RSS standards RSS 139 and RSS 210. Operation is subject to the following two conditions: (1) this device may not cause interference, and (2) this device must accept any interference, including interference that may cause undesired operation of the device.

This Class B digital apparatus complies with Canadian ICES-003. To comply with FCC and Industry Canada RF exposure limits for general population/ uncontrolled exposure, the antenna(s) used for this transmitter must be installed to provide a separation distance of 70 mm from all persons and operating in conjunction with any other antenna or transmitter, except in accordance with FCC multi-transmitter product procedures.

Other user manual statements may apply.

Le présent appareil est conforme aux CNR d'Industrie Canada applicables aux appareils radio exempts de licence. L'exploitation est autorisée aux deux conditions suivantes : (1) l'appareil ne doit pas produire de brouillage, et (2) l'utilisateur de l'appareil doit accepter tout brouillage radioélectrique subi, même si le brouillage est susceptible d'en compromettre le fonctionnement.

Cet appareil numérique de la classe B est conforme à la norme NMB-003 du Canada.

Pour se conformer aux limites d'exposition aux RF de la FCC et d'industries Canada pour la population générale/ exposition non contrôlée, l'antenne(s) utilisée pour ce transmetteur doit être installée pour fournir une distance de séparation d'au moins 70 mm de toutes les personnes et fonctionnant conjointement avec une autre antenne ou émetteur, sauf en conformité avec les procédures de produits multi-émetteur FCC.

Autres d'éclairations manuel de l'utilisateur peuvent s'appliquer.



## FEDERAL COMMUNICATIONS COMMISSION (FCC) STATEMENTS



This equipment has been tested and found to comply with the limits for a Class B digital device, pursuant to part 15 of the FCC Rules. These limits are designed to provide reasonable protection against harmful interference in a residential installation. This equipment generates, uses and can radiate radio frequency

energy and, if not installed and used in accordance with the instructions, may cause harmful interference to radio communications. However, there is no guarantee that interference will not occur in a particular installation. If this equipment does cause harmful interference to radio or television reception, which can be determined by turning the equipment off and on, the user is encouraged to try to correct the interference by one or more of the following measures:

- Reorient or relocate the receiving antenna.
- Increase the separation between the equipment and the receiver.
- Connect the equipment to an outlet on a circuit different from that to which the receiver is connected.
- Consult the dealer or an experienced radio/TV technician for help.

To maintain compliance with FCC regulations, shielded cables must be used with this equipment. Operation with non-approved equipment or unshielded cables is likely to result in interference to radio and TV reception. The user is cautioned that changes and modifications made to the equipment without the approval of manufacturer could void the user's authority to operate this equipment.

**NOTE:** This device complies with Part 15 of the FCC Rules. Operations subjected to the following two conditions (1) this device may not cause harmful interference, and (2) this device must accept any interference received, including that which may cause undesirable interference.



**CAUTION:** Exposure to Radio Frequency Radiation.

The device shall be used in such a manner that the potential for human contact is minimized.

This equipment complies with FCC radiation exposure limits set forth for an uncontrolled environment. This equipment should be installed and operated with a minimum distance of 20 cm between the radiator and your body.



**CAUTION:** Regulations of the FCC and FAA prohibit airborne operation of radio-frequency wireless devices because their signals could interfere with critical aircraft instruments.



**CAUTION:** If the device is changed or modified without permission from RED, the user may void his or her authority to operate the equipment.

## AUSTRALIA AND NEW ZEALAND STATEMENTS

RED declares that the radio equipment described in this document complies with the following international standards:

- IEC 62368-1 – Product Safety
- ETSI EN 300 328 – Technical requirement for radio equipment

RED declares digital devices described in this document comply with the following Australian and New Zealand standards:

- AS/NZS CISPR 22 – Electromagnetic Interference
- AS/NZS 61000.3.2 – Power Line Harmonics
- AS/NZS 61000.3.3 – Power Line Flicker

## SOUTH KOREA STATEMENTS

	1. Equipment Name/Model Name: 특정소출력무선기기 (무선데이터통신시스템용 무선기기) / KOMODO 6K, KOMODO ST
	2. Registration No.: R-R-DV5-2020KMD000
	3. Applicant Name: ㈜ 디브이인사이드
	4. Manufacture Date: 2020
	5. Manufacturer/Country of Origin: RED Digital Cinema, LLC / USA, Mexico

## SINGAPORE STATEMENTS

Complies with IMDS Standards N3434-20.

## THAILAND STATEMENTS

This telecommunication equipment conforms to NTC/NBTC technical requirements.

## JAPAN STATEMENTS

This equipment contains specified radio equipment that has been certified to the Technical Regulation Conformity Certification under the Radio Law.

本機器は、電波法に基づく技術基準適合証明等を受けた特定無線デバイスを使用しております。



201-180720

## SOUTH AFRICA STATEMENTS



## BRAZIL STATEMENT

This product is approved by ANATEL according to the procedures regulated for conformity assessment of telecommunications products and meets the applicable technical requirements, including the limits for measuring human exposure to electric, magnetic and electromagnetic radio frequency fields.

The product has a body Specific Absorption Rate (SAR) of 0.011 W/kg. This equipment is not entitled to protection against harmful interference and may not cause interference to properly authorized systems.



## EUROPEAN UNION COMPLIANCE STATEMENTS



RED declares that the radio equipment described in this document complies with the EMC Directive (2014/30/EU) and the Low Voltage Directive (2014/35/EU) issued by the Commission of the European Community. Compliance with this directive implies

conformity to the following European Norms (in brackets are the equivalent international standards).

- EN 62368-1 (IEC 62368-1) – Product Safety
- ETSI EN 300 328 Technical requirement for radio equipment
- ETSI EN 301 489 General EMC requirements for radio equipment
- EN 55032 (CISPR 32) Electromagnetic Compatibility
- EN 55035 (CISPR 35) Immunity Requirements
- EN 61000-3-2 (IEC 61000-3-2) Harmonic Current Emissions
- EN 61000-3-3 (IEC 61000-3-3) Voltage changes, voltage fluctuations and flicker
- EU 2015/863 RoHS Directive

## WASTE ELECTRICAL AND ELECTRONIC EQUIPMENT (WEEE)

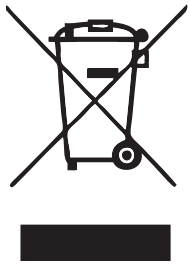

The Waste Electrical and Electronic Equipment (WEEE) mark applies only to countries within the European Union (EU) and Norway. This symbol on the product and accompanying documents means that used electrical and electronic products should not be mixed with general household waste. For proper treatment, recovery and recycling, take this product to designated collection points where it will be accepted free of charge. Alternatively, in some countries you may be able to return your

products to your local retailer upon purchase of an equivalent new product.

Disposing of this product correctly will help save valuable resources and prevent any potential negative effects on human health and the environment, which could otherwise arise from inappropriate waste handling. Contact your local authority for further details of your nearest designated collection point. Penalties may be applicable for incorrect disposal of this waste, in accordance with your national legislation. For business users in the European Union, if you wish to discard electrical and electronic equipment, contact your dealer or supplier for further information.

## RESPONSIBLE PARTY

RED Digital Cinema  
94 Icon  
Lake Forest, CA 92610  
USA

## SAFETY INSTRUCTIONS

- DO NOT use the camera or accessories near water. Avoid exposing your camera to moisture. The unit is not waterproof, so contact with water could cause permanent damage to the unit as well as electric shock and serious injury to the user. DO NOT use the camera in the rain or under other conditions with high moisture without appropriate protection, and immediately remove power source if camera or accessories are exposed to moisture.



**WARNING:** To reduce the risk of fire or electric shock, do not expose the camera to rain or moisture.



**CAUTION:** Proper camera ventilation requires a minimum 0.5" (1.25 cm) clearance between the camera ventilation openings and external surfaces. Verify that objects that can block the fan intake and exhaust ports do not impede airflow. Failure to permit adequate airflow may result in overheating of the camera, degraded operation and in extreme situations, damage to the camera.



**WARNING:** CFast media cards can become very hot during prolonged recording sessions. When ejecting the CFast media card, let it cool before touching it with bare fingers.

- DO NOT operate or store near any heat sources such as radiators, heat registers, stoves, or any other apparatus that produce heat. Store in a protected, level and ventilated place. Avoid exposure to temperature extremes, damp, severe vibration, strong magnetic fields, direct sunlight or local heat sources during storage. Remove any batteries from the camera before storage. Recommended storage and usage temperatures for your camera, lenses and other accessories are:
  - Operating range: 0° C to 40° C (32° F to 104° F)
  - Storage range: -20° C to 50° C (-4° F to 122° F)
- DO NOT point the camera directly into extreme light sources such as the sun or lasers. Permanent damage to optical path or sensor may occur, which is not covered by manufacturer's warranty.
- DO NOT expose the camera to laser beams, as laser beams may damage the sensor.
- DO NOT expose your camera to excessive vibration or impact (shock). Be careful not to drop your camera. Internal mechanisms may be damaged by severe shock. Mechanical alignment of optical elements may be affected by excessive vibration.
- **ELECTROMAGNETIC INTERFERENCE:** The use of devices using radio or other communication waves may result in the malfunction or interference with the unit and/or with audio and video signals.
- Clean only using a dry cloth. When cleaning your camera, remember that it is not waterproof and moisture can damage electronic circuitry. DO NOT rinse or immerse any element of the camera, lens or other accessory, keep them dry at all times. DO NOT use soaps, detergents, ammonia, alkaline cleaners, and abrasive cleaning compounds or solvents. These substances may damage lens coatings and electronic circuitry.
- Maintain sufficient ventilation—DO NOT block any ventilation openings or obstruct cooling fan airflow.

- If there are any performance issues with your camera or accessories when operating within this temperature range, submit a Support ticket at <https://support.red.com>.
- DO NOT bypass the third prong of the grounding-type plug on the power cord of the included power Adaptor. A grounding-type plug has two blades and a third “grounding” prong. The third prong is provided for your safety. You must connect the plug to an outlet with a protective earthen connection. If the grounding-type plug does not fit into your outlet, do not attempt to modify the plug or outlet, consult a qualified electrician.
- Protect all power cords from being pinched, walked on, or driven over by a vehicle. Replace any power cords suspected of sustaining damage due to crushing or other forms physical damage.



**CAUTION:** Install this camera in a proper support system that can handle the entire weight of the camera and the accessories. Secure the camera by using the ¼-20 and/or the 3/8-16 mounting points located on the bottom of the camera or on the Expander Module. Always verify that the screws are tightened properly. When the camera is not properly attached, or is placed on an unstable surface, the camera can fall and cause injury or be damaged.



**CAUTION:** Products marked with this symbol are class 2 devices. These devices are not provided with a grounding type plug.



**CAUTION:** The power cord plug for the included power adaptor is used as the power disconnect. To disconnect all power from the power adaptor, unplug the power cord plug from the wall outlet. During use, the power cord plug should remain easily accessible at all times.

- Lithium-ion batteries may be subject to special handling requirements pursuant to federal and local laws. Refer to specific shipping instructions included with your battery regarding proper transport of your battery. Do not handle your battery if it is damaged or leaking. Disposal of batteries must be in accordance with local environmental regulations. For example, California law requires that all rechargeable batteries must be recycled by an authorized recycle center. Storing batteries fully charged or in high temperature conditions may permanently reduce the life of the battery. Available battery capacity may also be temporarily lessened after storage in low temperature conditions.



**WARNING:** DO NOT expose the battery to excessive heat.



**CAUTION:** Refer all service and repair to qualified RED service personnel. To reduce the risk of electric shock, and damage to the camera or accessories, DO NOT attempt to perform any servicing other than any procedures that are recommended in the operating instructions.



**INDOOR USE ONLY:** This device is designed primarily for indoor use.

- El aparato no debe quedar expuesto a goteo o salpicaduras por líquidos.

## BATTERY STORAGE AND HANDLING



**WARNING:** Failure to read, understand, and follow these instructions may result in overheating, chemical leakage, smoke emission, fire, or other potentially harmful results.

- Read and adhere to all safety instructions provided by the manufacturer of the batteries.
- Always follow proper battery handling and storage practices. Improper handling and failure to abide by proper storage instructions may cause permanent damage to batteries, or degrade battery charge holding capacity. Improper handling practices or failure to comply with instructions may also put you at risk.
- Lithium-Ion batteries, like the Canon BP-900 series, self-discharge over time. When storing for long periods of time, store batteries separately from the camera or charger and remember to charge batteries to a capacity level of 40% to 60%. If batteries will be stored for long periods of time, RED recommends that you check the charge level at least once every six (6) months, and recharge batteries to a capacity level of 40% to 60%.
- When not in use, remove the battery from the camera or charger and store the battery in a cool, dry place. Avoid extreme hot temperatures (such as inside a hot car), corrosive gas, and direct sunlight. The optimal storage temperature for batteries is between –20° C to 20° C (–4° F to 68° F).



**WARNING:** Batteries stored in a discharged state for long periods of time may self-discharge and lose the ability to hold a charge.



**WARNING:** If recharging operation fails to complete even when a specified recharging time has elapsed, immediately stop further recharging.

- DO NOT store batteries in a fully charged state for extended periods of time.
- DO NOT store batteries in a fully discharged state for extended periods of time.
- DO NOT store batteries in the camera or in a charger for extended periods of time.
- DO NOT use batteries for purposes other than their intended use.
- DO NOT store batteries in extreme hot or cold temperatures.
- DO NOT store batteries in direct sunlight.
- DO NOT disassemble or modify the battery.
- DO NOT overcharge batteries. Overcharging may increase internal temperature beyond the recommended limits and cause permanent damage to the battery.
- DO NOT connect the positive (+) and negative (–) terminals to a metal object such as a wire.
- DO NOT transport or store the battery together with metal objects such as jewelry, hairpins, etc. as they may generate heat if they come into contact with the battery.
- DO NOT discard the battery into fire or heat.
- DO NOT store, use, or recharge the battery near a heat source such as a fire or a heater.
- DO NOT allow the battery to get wet.
- DO NOT pierce the battery with pointed or other sharp objects.
- DO NOT step on, throw, or strike the battery with a hammer.
- DO NOT use a battery that appears to be deformed or damaged.
- DO NOT directly solder the battery.

- DO NOT put the battery into a microwave oven or a pressurized container.
- DO NOT use or subject the battery to intense sunlight or hot temperatures such as in a car in hot weather.
- DO NOT use it in a location where static electricity may be present.
- DO NOT exceed the recharging temperature range of 0° C to 40° C (32° F to 104° F).
- Store the battery in a location where children cannot reach it.
- If the battery leaks or gives off a bad odor, discontinue use immediately.
- If the battery gives off an odor, generates heat, becomes discolored or deformed, or in any way appears abnormal during use, recharging or storage, immediately remove it from the equipment or battery charger and discontinue use.
- If electrolyte begins leaking from the battery and comes into contact with your skin or clothing, immediately wash it away with running water. Failure to do this may result in skin inflammation.
- If the battery leaks and the electrolyte reaches the eyes, do not rub them. Instead, rinse the eyes with clean running water and immediately seek medical attention. Failure to do this may result in eye injury.

# 1. INTRODUCTION



Figure: KOMODO camera

## KOMODO

KOMODO® 6K is the latest breakthrough product in RED's long line of innovative image capture technology. The newest entrant into the RED lineup is a compact, all-in-one, and highly powerful cinema camera. It features RED's cinema grade image quality, color science, and sensor technology in a portable form factor cinematographers can take anywhere and adapt to any shooting scenario.

The new sensor in KOMODO is a 6K S35 global shutter CMOS sensor. This sensor breaks new technical ground by retaining wide dynamic range and delivering unmatched RED imagery, without compromising creative or technical features. KOMODO includes a built-in Canon RF-style mount allowing users the flexibility to use RF-type lenses and several lens Adaptors, such as EF-type, PL, and Leica M mount.

The KOMODO records using R3D or ProRes formats written to a CFast 2.0 media card. The RED KOMODO is powered by REDVOLT BP batteries or a power cable. Control the KOMODO features with the top **LCD Touchscreen**, or you can use the screen to watch playback.

## QUICK REFERENCE

Refer to the **Quick Reference** section to get familiar with this guide and the camera.

## R3D FILE FORMAT AND REDCODE

All videos and frames are recorded to the R3D<sup>®</sup> file format. The R3D file format was developed by RED to provide an efficient and manageable RAW video data format that promotes advanced post production editing capabilities. In the R3D file format, the digital image received from the sensor is formatted as a pixel-defect corrected (but in all other aspects unprocessed) 16-bit per pixel RAW data frame. Each RAW frame, or sequence of RAW frames in a clip, is compressed using proprietary REDCODE<sup>®</sup> RAW compression, then stored to media.

RAW data is recorded independently of any RGB domain color processing such as ISO, White Balance, or other RGB color space settings. Instead, color parameters are saved as reference metadata; that is, color is not burned into the recorded RAW data. This recording technique promotes flexibility in RGB color processing, which can be deferred to post production or adjusted in the field, without affecting the recorded RAW data image quality or dynamic range.

REDCODE is a compression codec that reduces R3D RAW files into a manageable size, allowing longer recording times on media. The ability to compress RAW data is one of the significant technologies that RED has brought to the industry.

## GLOBAL SHUTTER

This camera employs global shutter technology. This technology exposes all of the sensor's pixels in each frame simultaneously, unlike a rolling shutter that exposes lines of pixels (each with a delay) causing image artifacts on fast-moving objects. Global shutter technology not only improves the visual appearance of this camera's images, it also eliminates tracking and matte-painting distortions during post production.

## IMAGE PROCESSING PIPELINE

This camera uses the new RED Image Processing Pipeline 2 (IPP2). In IPP2, the advanced RED color space (REDWideGamutRGB) allows the camera to use every color its sensor can generate without clipping. The camera then encodes the image using Log3G10, a gamma curve that retains extreme highlight and shadow detail. Using the advanced color space and gamma curve, RED IPP2 allows you to grade and make color adjustments in post-production, instead of in-camera. IPP2 also allows the camera to use [CDL](#) for grading. For more information about IPP2, refer to the [RED IPP2](#) support page.

## SHOOT FOR VIDEO AND STILLS

High resolution video, such as the digital footage captured by the camera, has surpassed the detail necessary to produce professional full-sized prints. Because of the ability to record at high frame rates and resolution, the camera is ideally suited to capture video and still images, simultaneously.



## POST PRODUCTION

Many non-linear editing systems (NLEs) can open and edit RED footage. Each NLE version may have specific compatibility requirements, such as camera firmware version or camera type. Before shooting, check all compatibility requirements.

The following programs can be used to open and/or edit R3D files:

- **REDCINE-X PRO:** RED's proprietary application. Download [REDCINE-X PRO for Windows](#) or [REDCINE-X PRO for Mac](#) from [www.red.com/downloads](http://www.red.com/downloads).
- **Adobe Premiere Pro**
- **Avid Media Composer**
- **DaVinci Resolve**
- **Final Cut Pro X:** Requires you to download the [RED Apple Workflow Installer](#) from [www.red.com/downloads](http://www.red.com/downloads).
- **Adobe PhotoShop:** Can open .R3D files, however, you must download the [RED Adobe PhotoShop Installer for Windows](#) or [RED Adobe PhotoShop Installer for Mac](#) from [www.red.com/downloads](http://www.red.com/downloads).
- **Foundry Nuke**
- **Assimilate Scratch**
- **AutoDesk Flame**
- **ColorFront Transkoder** (beta for latest support)

**NOTE:** Third-party applications may have limited compatibility with R3D files. Third-party developers must use the most recent [R3D SDK](#) to offer compatibility with the latest RED firmware.

## POST PRODUCTION WITH REDCINE-X PRO

REDCINE-X PRO is a professional one-light coloring tool set, equipped with an integrated time line, and with a collection of post effects software. These tools provide the ideal environment to review recorded footage, edit metadata, organize projects, and prepare your R3D files. You can use REDCINE-X PRO or any of the compatible third-party NLEs to edit R3D files.

## ADDITIONAL RESOURCES

- **RED.com:** Check the [official RED website](#) for the latest information about RED products.
- **RED Downloads:** Go to [RED Downloads](#) to download the latest firmware, operation guides, and post production software.
- **RED 101 Articles:** RED offers [in-depth technical articles](#) about RED cameras, post production, and digital cinematography.
- **RED TECH Videos:** RED offers [videos](#) about understanding and using RED cameras.
- **RED Support:** Check the [RED SUPPORT site](#) for support articles or to file a support ticket.

## 2. QUICK REFERENCE

Congratulations new RED KOMODO camera owner. This quick reference topic helps you get familiar with this guide and the **Camera Body**. It includes links to topics about configuring the camera to fit your recording requirements, and for learning the basic operation of the camera.

### PREPARING THE CAMERA HARDWARE

Prepare the camera hardware for recording by:

- Installing compatible **Lenses and Adaptors**
- **Inserting the Media**
- Connecting a power source (refer to **Power** or **KOMODO Power Adaptor**)
- **Turning On the Camera**

### PREPARING THE CAMERA SYSTEM

Configure the camera settings to prepare for recording (refer to the **System Settings Menu**).

### CONFIGURING THE SETTINGS

- Configuring the camera system settings
- **Upgrading the Firmware**
- Calibrating the camera using the **Calibrate** feature
- Formatting the media (refer to **Secure Format**)
- Specifying the desired recording resolution (refer to **Format**)
- Configuring the **Recording Frame Rate** and **Project Time Base**
- Setting the exposure (refer to **Shutter**)
- Configuring the monitoring tools and reviewing the monitored image (refer to the **Monitoring Menu**)
- Reviewing the camera status (refer to **System Status**)

### RECORDING

Start recording your project.

- Record by pressing the REC button on the **Camera Body** or **KOMODO Outrigger Handle**
- Record by using the **LCD Touchscreen**
- Record by using an external trigger (refer to **Extension Port** and **KOMODO Expander Module**)
- Record by using USB-C (refer to **KOMODO Link Adaptor**)
- Record by using Wi-Fi (refer to the **Communication Menu**)

### PROCESSING FOOTAGE

Perform post-production using any of the standard applications.

- Adobe® Premiere® Pro
- Avid® Media Composer®
- DaVinci Resolve®
- Final Cut Pro X®

## 3. CAMERA COMPONENTS

### CAMERA BODY

This section describes the **Front**, **Top**, **Left**, **Right**, **Back**, and **Bottom** of the camera, and identifies the controls, buttons, **Camera Body LEDs**, and the lens mount on the body.

### CAMERA BODY CONTROLS AND FEATURES

This section describes the controls and features of the camera.

#### FRONT



Figure: Camera Body Front Controls and Features

#	ITEM	DESCRIPTION
1	Lens mount	Lens mount for RF type lenses and adaptors (refer to <a href="#">Lenses and Adaptors</a> )
2	Mic 1	Left <a href="#">Internal Microphone</a> channel
3	Mic 2	Right <a href="#">Internal Microphone</a> channel
4	Tally Light	Tally light (refer to <a href="#">Camera Body LEDs and Indicators</a> )

TOP



Figure: Camera Body Top Controls and Features

#	ITEM	DESCRIPTION
1	LCD Touchscreen	Camera <b>LCD Touchscreen</b>
2	MENU (BACK) Button	Menu button, Back button
3	Up Arrow (LOCK) Button	Navigates up in the menu and locks/unlocks the UI when pressed along with the other Lock button
4	Down Arrow (LOCK) Button	Navigates down in the menu and locks/unlocks the UI when pressed along with the other Lock button
5	Select (FN) Button	Selects the highlighted menu item and enables the (Function) buttons
6	Playback Button	Opens the <b>Playback</b> screen
7	1/4-20 Mounting Holes	1/4-20 mounting holes for optional accessories (refer to <b>KOMODO Outrigger Handle</b> )
8	Accessory Port	Connection port for accessories (refer to <b>KOMODO Outrigger Handle</b> )

**LEFT**



Figure: Camera Body Left Controls and Features

#	ITEM	DESCRIPTION
1	External Mic Jack	3.5 mm stereo microphone input
2	Headphone Jack	3.5 mm stereo headphone output
3	Media Bay	CFast 2.0 media bay
4	CFast LED	CFast status indicator (refer to <a href="#">Camera Body LEDs</a> )
5	EJECT Button	Left battery release button
6	M4 Mounting Holes	Two (2) M4 mounting points for accessories
7	Focus Plane	Focus plane indicator symbol
8	Beep Speaker	Camera beep speaker

**RIGHT**

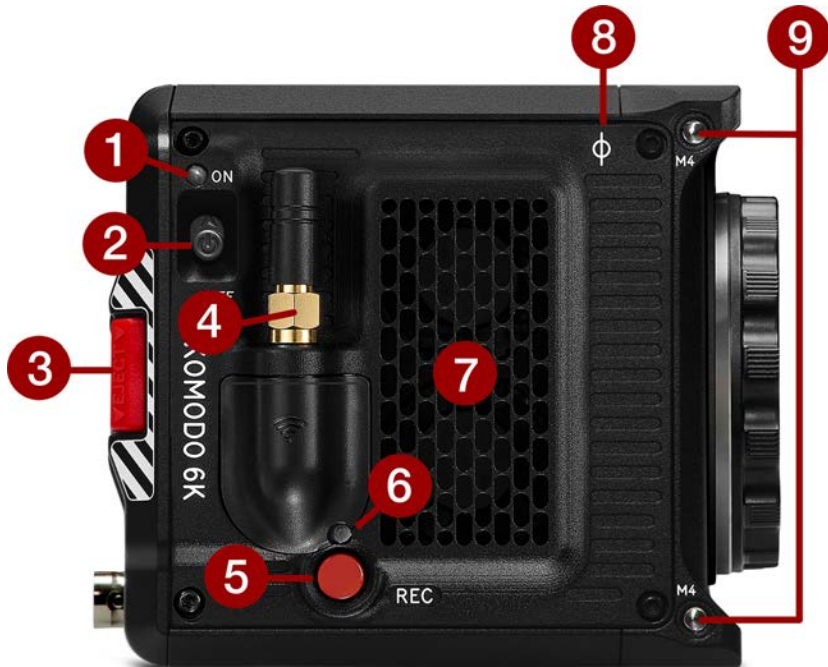

Figure: Camera Body Right Controls and Features

#	ITEM	DESCRIPTION
1	Power LED	Displays the camera ready status (refer to <a href="#">Camera Body LEDs</a> )
2	ON/OFF Switch	Slide up to turn on the camera and slide down to turn off the camera
3	EJECT Button	Right battery release button
4	Wireless Antenna	Wi-Fi antenna mounted to a female RP-SMA connector. Supports dual band 2.4 GHz or 5 GHz
5	REC button	Press and release the <b>REC</b> button to toggle between record start and stop
6	Record LED	Displays the camera recording status (refer to <a href="#">Camera Body LEDs</a> )
7	Air Intake	Air intake for thermal management
8	Focus Plane	Focus plane indicator symbol
9	M4 Mounting Holes	Two (2) M4 mounting points for accessories



**BACK**



Figure: Camera Body Rear Controls and Features

#	ITEM	DESCRIPTION
1	Battery mounts	Two mounts for the batteries (refer to <a href="#">Batteries</a> )
2	Eject buttons	Right and left battery release buttons
3	9-pin <a href="#">Extension Port</a>	9-pin 0B ODU port (refer to <a href="#">KOMODO Expander Module</a> )
4	12G- <a href="#">SDI</a> port	Full-size 12G-SDI BNC port for SDI monitor connection <sup>1,2</sup>
5	2-pin <a href="#">DC-Input</a> port	2-pin 0B ODU for DC-IN with wide input voltage support (7-17 Volts)
6	DC-IN/Battery LED	Displays the camera power status (refer to <a href="#">DC/Battery LED</a> )

1. Use certified 12G-SDI cables.
2. **WARNING:** Always connect the accessories' DC power cable (or batteries) before connecting the BNC SDI cable. Always remove the BNC SDI cable before removing the accessories' DC power cable (or batteries). For more information, refer to [Preventing Damage to SDI Outputs](#).

## BOTTOM



Figure: Camera Body Bottom Controls and Features

#	ITEM	DESCRIPTION
1	Mounting Points	One (1) 1/4"-20 mounting hole and one (1) 3/8"-16 mounting hole (refer to <b>KOMODO Expander Module</b> )
2	Registration Points	Indented alignment points for the <b>KOMODO Expander Module</b>
3	Service Port	For RED service only - DO NOT REMOVE

## CAMERA BODY LEDS

### FRONT LED



Figure: KOMODO 6K LED, Front

#	ITEM	COLOR	DESCRIPTION
1	Tally Indicator LED	Red	When enabled, this LED is ON when the camera is recording. For information about enabling this LED, refer to <a href="#">Indicators</a> .

**LEFT SIDE LED**



Figure: KOMODO 6K LED, Left Side

#	ITEM	COLOR/FLASHING	DESCRIPTION
1	CFast Media LED	Off	No media mounted
		Green	Preview; media mounted with > 10% of media space available
		Amber	Recording finalizing or playback mode
		Amber flashing slow	Formatting media
		Red flashing slow	Media mounted with >5% and <= 10% of media space available
		Red flashing fast	Media mounted with <= 5% of media space available
		Red	Recording

**RIGHT SIDE LEDS**



Figure: KOMODO 6K LED, Right Side

#	ITEM	COLOR/FLASHING	DESCRIPTION
1	Power Status (ON)	Off	Camera OFF
		Amber	Camera booting
		Green	Camera ON
		Amber flashing	Camera on; 5 to 10 min of battery time available
		Red flashing	Camera on; < 5 min of battery time available
		Red	Camera shutting down
2	Record Status (REC)	Off	No media present
		Green	Ready to record
		Red	Recording
		Amber	Finalizing
		Red flashing slow	Media mounted with >5% and <= 10% of media space available
		Red flashing fast	Media mounted with <= 5% of media space available
	Power and Record	Both flashing green	Firmware update in progress
		Both flashing red	Firmware update error (refer to <a href="#">Upgrading the Firmware</a> )

**DC/BATTERY LED**



Figure: KOMODO 6K, DC/Battery LED

#	ITEM	COLOR	DESCRIPTION
1	DC-IN	Green	DC-IN is present and / or the battery is fully charged
		Flashing Amber	Communicating with, and evaluating the battery
		Amber	Charging connected batteries
		Red	Error charging the batteries



## BATTERIES

The camera has two battery slots for REDVOLT BP batteries. The camera also accepts Canon BP-900 series batteries. The left battery slot (facing the back of the camera) has priority over the right battery slot. Refer to **Power Priority** for more information.

The camera charges the batteries when the camera is off and a power cable is connected.

**WARNING:** Use RED-compatible batteries only.

This camera is designed to achieve optimum performance when used with RED-compatible batteries. For a list of RED-compatible batteries, refer to **RED.COM**.

RED shall not be liable for any damage to this product and/or accidents such as malfunction, fire, etc., caused by the failure of incompatible batteries (e.g., a leakage and/or explosion of a battery pack). Please note that repairs arising out of the malfunction of incompatible batteries will not be covered by the warranty for repairs.

Using the batteries with an incompatible battery charger or product may result in malfunction or accidents for which RED cannot be held liable.

## REDVOLT BP

**Battery Type:** Rechargeable Lithium-ion battery

**Operating Temperature:** 10° C~45° C (50° F~113° F)

**Rated Voltage:** 7.2 V

**Capacity:** 6300 mAh / 45 Wh

**Dimensions:** Height: 2.78 in. (70.5 mm), Width: 1.52 in. (38.7 mm), Depth: 1.71 in. (43.5 mm)

**Weight:** 7.8 ounces



## CANON BP-955



**Battery Type:** Rechargeable Lithium-Ion battery

**Operating Temperature:** 32° - 104° F (0° - 40° C)

**Rated Voltage:** 7.4 V DC

**Capacity:** 5200 mAh typical / 4900 mAh (37 Wh) minimum

**Dimensions:** Width=1.504", Height=2.773", Depth=1.7"

**Weight:** 7.8 ounces

4 LEDs indicate the remaining battery life.

## CANON BP-975



**Battery Type:** Rechargeable Lithium-Ion battery

**Operating Temperature:** 32° - 104° F (0° - 40° C)

**Rated Voltage:** 7.4 V DC

**Capacity:** 7800 mAh typical / 7350 mAh (55 Wh) minimum

**Dimensions:** Width=1.504", Height=2.773", Depth=2.45"

**Weight:** 11.3 ounces

As much as 50% more recording time than the BP-955. 4 LEDs indicate the remaining battery life.

## LENSES AND ADAPTORS

This section lists the compatible lenses and Adaptors for the camera. It also provides the steps for [Attaching Lenses](#) and [Removing Lenses](#).

For more information on a specific lens or Adaptor, refer to the original manufacturer's instructions.

**WARNING:** When the camera is not in use, protect lenses and the camera sensor by attaching the lens caps and camera mount cap.



*Figure: Camera with mount cap installed.*

Incompatible lenses do not register on the camera UI and they will not show any UI lens information or menu controls. The camera can control compatible lenses electronically, including the following features:

- Iris - The UI menu is enabled and the camera can control the lens Iris
- Autofocus - The UI menu is enabled for lenses that support autofocus
- Image Stabilization - The UI indicates that image stabilization is present
- Control Ring - The UI menu is enabled and the camera can use the control ring

For more information, refer to the [Lens](#) menu.

## COMPATIBLE LENSES

RED tested the following lenses and confirmed the functionality for use with the camera:

- Canon RF 15-35 mm f/2.8 L IS USM
- Canon RF 24-70 mm f/2.8 L IS USM
- Canon RF 24-105 mm f/4 L IS USM
- Canon RF 24-240 mm f/4-6.3 IS USM
- Canon RF 28-70 mm f/2 L USM
- Canon RF 35 mm f/1.8 Macro IS STM
- Canon RF 50 mm f/1.2 L USM
- Canon RF 70-200 mm f/2.8 L IS USM
- Canon RF 85 mm f/1.2 L USM DS
- Canon RF 100-500 mm f/4.5 - 7.1 L IS USM
- Canon RF 800 mm f/11 IS STM
- Canon EF 14 mm f/2.8L II USM
- Canon EF 24 mm f/1.4L II USM
- Canon EF 35 mm f/1.4L II USM
- Canon EF 50 mm f/1.2L USM
- Canon EF 85 mm f/1.2L II USM
- Canon EF-S 17-55 f/2.8 IS USM
- Canon EF 24-70 f/2.8L II USM
- Canon EF 16-35 f/2.8L III USM
- Canon EF 24-105 f/4L IS II USM
- Canon EF 70-200 mm f/2.8L IS III USM

## LENS WEIGHT AND LENS SUPPORT

Use a lens support system when mounting heavy or long lenses to your camera.

When mounting a heavy or long lens, ensure that the full weight of the lens is never directly on the camera or lens mount. Mount the lens to the support system first, and then carefully mount the lens to the camera.

## COMPATIBLE MOUNT ADAPTORS

RED tested the following adaptors and determined that they are compatible with the camera:

- Canon Mount Adaptor EF-EOS R
- Canon Drop-In Filter Mount Adaptor EF-EOS R with Variable ND Filter / Clear Filter / Circular Polarizer

## ATTACHING LENSES

1. Remove the mount cap from the camera.
2. Remove the mount cap from the mount end of the lens.
3. Align the red dots and insert the lens in the camera.
4. Turn the lens clockwise until it clicks in place.
5. Store the mount caps.

## REMOVING LENSES

1. Press and hold the lens release button on the camera. While holding the lens release button, turn the lens counter-clockwise until it stops and remove it from the camera.
2. Align the red dot on the camera mount cap with the red dot on the camera and attach the mount cap to the camera.
3. Turn the camera mount cap clockwise until it clicks in place.
4. Align the red dot on the lens mount cap with the red dot on the lens and attach the mount cap to the lens.
5. Turn the lens mount cap clockwise until it clicks in place.
6. Store the lens with the caps attached to both ends.

## RED CFAST 2.0 READER



The RED CFast 2.0 Card Reader provides a fast USB-C connection with the capability of write-protect.

Set the Write-Protect switch to the Lock position to prevent connected devices from adding any unwanted files to your CFast 2.0 card.

**NOTE:** You can use the RED CFast 2.0 card reader with Write-Protect to prevent the Mac OS from indexing your CFast 2.0 card. For more information refer to the How To section ([Media Best Practices](#)).

## KOMODO EXPANDER MODULE

The KOMODO Expander Module provides extra hardware mounting points and connections for GPI, Genlock, Timecode, and CTRL (RS-232 control).



The KOMODO Expander Module connects to the camera through the [Extension Port](#).

#	CONNECTOR	CONNECTOR TYPE	DETAILS
1	Module cable	9-pin 0B ODU	Attaches to the back of the <a href="#">Camera Body</a>
2	GPI	BNC	Connection for remote trigger
3	Genlock	BNC	Connection for external Genlock device
4	Timecode	BNC	Connection for external Timecode device
5	CTRL	4-pin 00B ODU	<a href="#">CTRL (RS-232 Control)</a> port for external RS-232 connection

## KOMODO LINK ADAPTOR



The KOMODO® Link Adaptor provides KOMODO with a USB-C interface to extend the usability of the camera. Directly connect the KOMODO Link Adaptor to an iPhone or Android device, and experience a live preview with minimal latency using the RED Control app. Attach a USB-C to Ethernet adapter (not included) to the KOMODO Link Adaptor and you can remotely control the camera using an Ethernet-connected device.

Remote control allows you to:

- Access the camera remotely over long distances
- Transfer data over FTPS
- Connect to the camera when Wi-Fi is not an option
- Control a wired camera array (through the use of RCP2 API commands)

**NOTE:** The KOMODO Link Adaptor is mounted on the top front of the camera, which prevents the mounting of the KOMODO Outrigger Handle.

For more information, refer to the How To section ([KOMODO Link Adaptor](#)).

## KOMODO OUTRIGGER HANDLE

The KOMODO Outrigger Handle offers a low profile, 360° adjustable ergonomic pistol grip and integrated Record Start/Stop button. Mounted to the Top Handle Port on your camera, the KOMODO Outrigger Handle provides comfort, stability, and additional 1/4-20 mounting points for your peripheral camera components. The built-in Record button puts Start/Stop functionality right at your fingertips. You are always ready to capture the perfect shot.



The KOMODO Outrigger Handle is ideal for shooters who use one hand on the handle, for grip and record button access, and the other for lens adjustments or support.



## KOMODO WING GRIP

The KOMODO Wing Grip offers comfort and utility for carrying or shooting with your KOMODO.



Featuring an ergonomic machined grip with tactical 1/4-20 mounting points. It is lightweight and offers a seamless low-profile hand-held option.



The KOMODO Wing Grip is a simple handle and that provides extra mounting options for your camera.

## LCD TOUCHSCREEN



This section describes the structure and layout of the graphical user interface (GUI) for the built-in camera touchscreen LCD. Advanced GUI menu controls enable convenient access to menus, camera features, and critical camera information.

NOTE: After 1 hour of inactivity, the touchscreen will go to sleep. Tap the touchscreen or touch any button to wake the touchscreen. The touchscreen will not sleep while the camera is recording.

The LCD Touchscreen home page contains the following features:

## STATUS BAR



The **Status Bar** contains the button for displaying the Home screen and Menu screen. It also contains status icons for various camera settings and inputs.

When you tap the Home/Menu toggle button (RED logo), the camera toggles the display between the menu page and the home page:

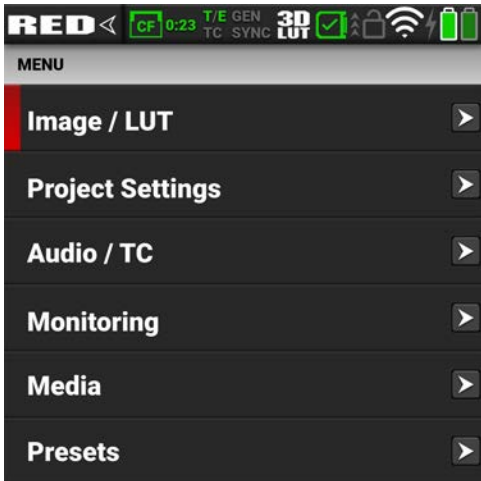

When you tap the Status bar icons the **Status Page** displays:

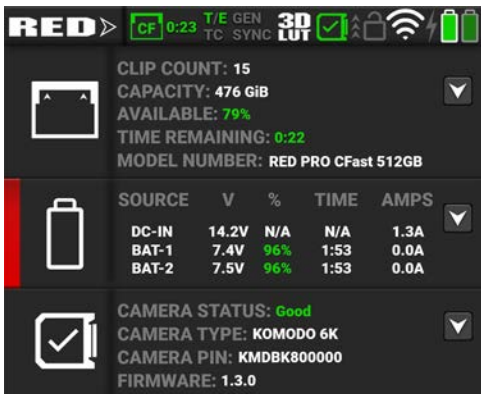

## EXPOSURE

The Exposure section of the LCD home page displays the RGB exposure levels for the camera.

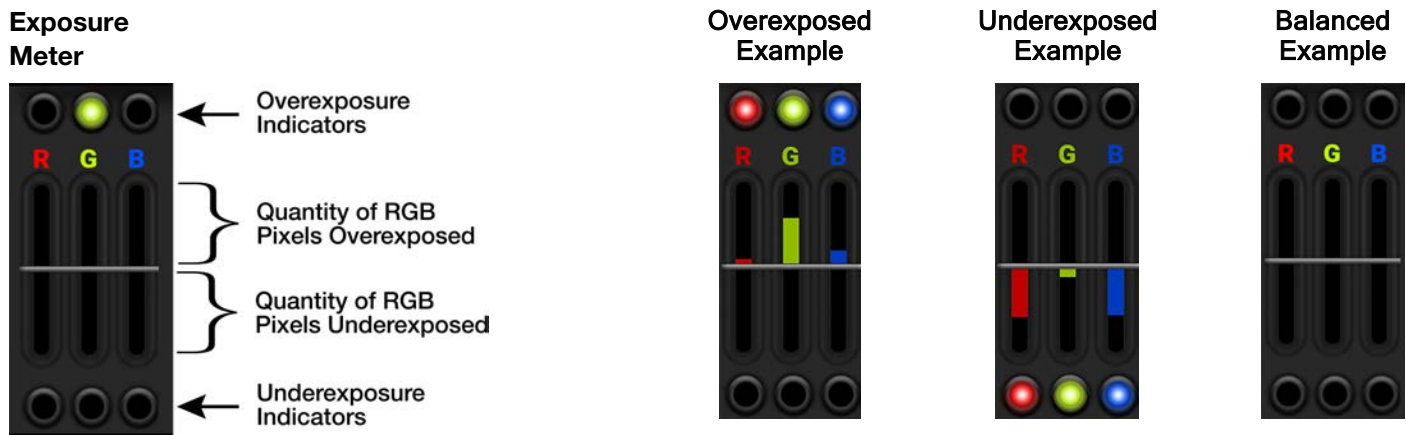

RGB Exposure displays the pixel exposure quantity of the separate RGB channels and indicates when a channel is underexposed or overexposed. This meter measures the raw image data regardless of the ISO and LUT settings.

The top and bottom RGB lights illuminate when a small number of pixels on the sensor are overexposed or underexposed. This indicates that a small bright or dark area is in the image.

The level bars show the levels of overexposed and underexposed RGB pixels on the sensor. Adjust the settings on the camera to compensate.

Tap the Exposure section to toggle between this display and the [Monitoring Tools](#) page display.

## MEDIA / HISTOGRAM



The Media section of the LCD home page displays the Timecode or Edgecode, clip ID, clip duration, resolution/format, and frame rate for the camera. Tap the Media section to toggle between this display and the Histogram display.

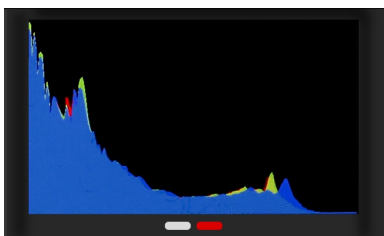

The Histogram section of the LCD home page displays the image color histogram. Tap this area to toggle between this display and the Media display. For more information, refer to [Histogram](#).

## AUDIO



The Audio section of the LCD home page displays the audio levels for the camera. Tap the Audio section to toggle between this display and the **Audio Tools** display.

The Audio VU meters display the audio levels in decibel (dB) for the selected channels. Refer to the Audio / TC Menu section for more information about the audio channels.

In this example, channel 2 displays the VU meter clipping at maximum dB.

## CAMERA DESIGNATION AND REC BUTTON



The Camera Designation and Record button on the LCD touchscreen home page displays the camera letter assigned to the camera (refer to **Slate** and **Camera ID**). You can tap this area to start pre-recording, and to start and stop recording.

Pre-recording:



Recording:



## QUICK SETTINGS



The Quick Settings section of the LCD home page displays the Quick Settings buttons for changing the most often used camera settings. These settings include **Recording Frame Rate**, **ISO**, **IRIS** (refer to **Lens**), **Shutter**, and **White Balance**.



Tap on a button to change the settings.

Swipe the setting left or right to make a selection.

Tap on the Quick Setting button to close the selection screen.

## BUTTON NAVIGATION

Pressing the Menu button next to the LCD touchscreen opens the main menu page. You can select the desired menu items by using the Up, Down, and Select (SEL) buttons. Pressing the Menu button also navigates backwards (BACK) from submenus in the menu tree.

Pressing the Up arrow and the Down arrow simultaneously locks/unlocks the touchscreen and the menu buttons. The Lock icon in the Status bar displays the lock status. The REC button is not locked and it functions normally.

Pressing the Playback button starts and stops playback (refer to **Playback** for more information).

Home Screen



Menu Screen



The menus include:

<b>MENUS</b>	<b>DETAILS</b>
Image / LUT Menu	ISO, Shutter, White Balance, Output Color Space, Output Tone Map, Highlight Roll-Off, Display Preset, 3D LUT, CDL, Exposure Adjust
Project Settings Menu	Format, Recording Frame Rate, Project Time Base, File Format, R3D Quality, ProRes Resolution, ProRes Codec, ProRes Color Profile, Pre-Record, Recording Mode, Timelapse, Frame Limit, Slate
Audio / TC Menu	Audio Source, Internal Mic, External Audio, Headphone, Timecode Source, Jam Timecode to TOD, Timecode Display Mode
Monitoring Menu	LCD, SDI, Live Stream, Tools, Guides
Media Menu	Eject, Media Info, Secure Format
Presets Menu	Create Preset, On Media, In Camera
Autofocus - BETA Menu	Enable, Mode, Size, Position, Start AF
Communication Menu	Camera, Wi-Fi, Serial, KOMODO Link Adaptor, FTPS
System Settings Menu	Date / Time, Lens, Power, Indicators, GPO, Status Settings, System Status
Language Menu	English, Chinese, French, German, Japanese, Spanish
Maintenance Menu	Calibrate, Calibration, Save Log, Reset Defaults, Factory Reset, Upgrade



## STATUS BAR

The top of the LCD screen displays the camera status bar.



The Status Bar contains the following button and icons:

- **RED >** Home / Menu Button
- **CF 0:14** CFast Status Icon
- **T/E** Temperature / Exposure Icon
- **TC** Timecode Icon
- **GEN** Genlock Icon
- **SYNC** SYNC Icon
- **3D LUT** 3D LUT Icon
- **✓** Camera Status Icon
- **⬆** FTPS Activity Icon
- **🔒** LCD Lock Icon
- **📶** Wi-Fi Icon
- **⚡** DC-In Icon
- **🔋** Battery Icon

## HOME / MENU BUTTON



This button toggles the LCD display between the Home screen and the Menu screen. The arrow on the button changes direction when toggled.

Home Screen:



Menu Screen:

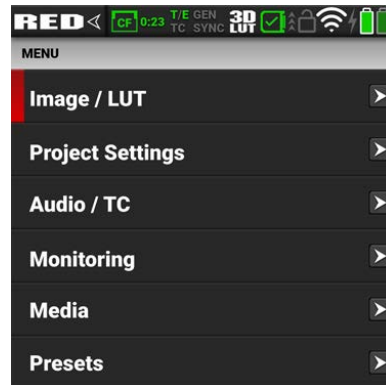

### CFAST STATUS ICON



This icon displays the status of the CFast 2.0 media card, and it displays the recording time remaining for the current camera settings.

The status displayed includes:



Good



Missing



Incompatible

### CAMERA STATUS ICON



This icon indicates the state of the camera hardware. The different icons and their corresponding status include:



Good



Overheating Warning



Overheating



Shutting Down

### FTPS ACTIVITY ICON



This icon indicates the state of FTPS data transfer.



Gray indicates that the FTPS is not transferring data.



Green indicates that the camera is transferring FTPS data.

### TEMPERATURE / EXPOSURE ICON



This icon displays the temperature (T) and exposure (E) calibration indicators.

- When T is yellow or red, it indicates that the camera requires sensor re-calibration.
- When E is yellow or red, it indicates that the camera requires sensor re-calibration.

Refer to [Calibrating the Sensor](#).

### LCD LOCK ICON



This icon indicates the state of the LCD Lock. The states include:



Gray and open indicates that the camera LCD is unlocked.



White and closed indicates that the camera LCD is locked.

### TIMECODE ICON



This icon indicates the state of the Timecode generator connection.



Gray indicates that no Timecode generator signal is detected.



Green indicates that the Timecode source is connected and jammed.



Red indicates that the Timecode source is connected and not jammed.



White indicates that the Timecode source is jammed and not connected.



Yellow indicates that the Timecode source is cross-jammed (at a different [Project Time Base](#)).

---

## WI-FI ICON

---



This icon indicates the state of Wi-Fi connection.



Gray and empty indicates that no Wi-Fi signal is detected.



White bars indicate that Wi-Fi signal is detected (Infrastructure).



White antenna indicates that Wi-Fi signal is broadcasting (Ad-hoc).

---

## GENLOCK ICON

---



This icon indicates the state of the Genlock connection.



Gray indicates that no Genlock signal is detected.



Green indicates that the camera is receiving and is locked to a Genlock signal.



Red indicates that the camera is receiving and is not locked to a Genlock signal.

---

## SYNC ICON

---



This icon indicates that the Timecode and Genlock signals are synchronized to the camera's frames per second (FPS) settings.



Gray indicates that no synchronization is detected.



Green indicates that the camera's sensor is synchronized with Timecode and that the camera's output is synchronized with Genlock.



Yellow indicates that the camera's sensor is **NOT** synchronized with Timecode and that the camera's output is synchronized with a single camera or a Genlock signal.

---

## DC-IN ICON

---



This icon indicates the state of DC power connection.



Gray indicates that no DC power is connected.



Green indicates that the camera is receiving DC power.

---

## 3D LUT ICON

---



This icon indicates the activation status of 3D LUTs.



Gray indicates that no 3D LUTs are in use.



White indicates that the camera is using a 3D LUT.

---

## BATTERY ICON

---



This icon indicates the state of the battery connection and charge level.



Gray indicates that no battery is connected.



White indicates that the battery is connected and green shows the relative level of charge remaining.



Yellow indicates 10 minutes of power remaining.



Red indicates less than 5 minutes of power remaining.



Gray question mark indicates no communication with the battery and no power.



White question mark indicates no communication with the battery and power.



Gray exclamation point indicates error communicating with the battery and no power.

---

## STATUS PAGE

The Status page contains camera status information and shortcuts to the associated camera menus:

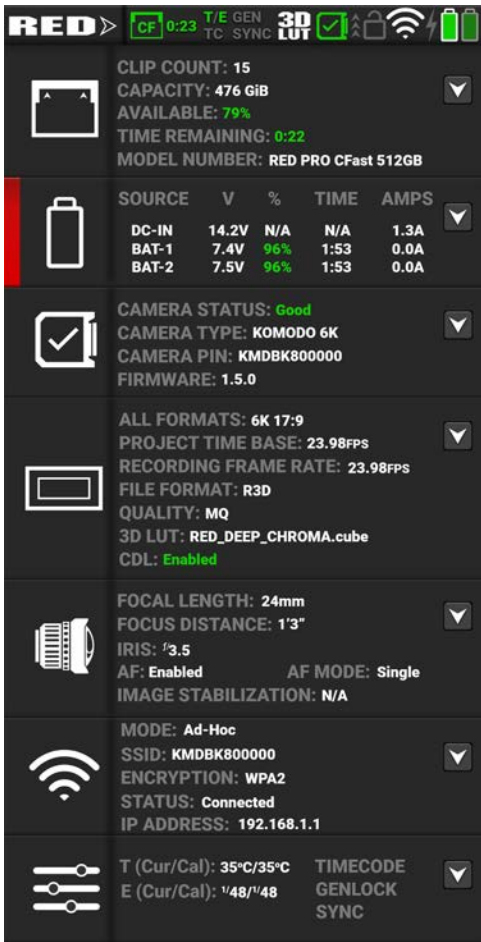

The camera status and menu shortcuts include:

ITEM	DETAILS
Media	Displays the media status and a link to the <a href="#">Media Menu</a>
Power	Displays the power status and a link to the <a href="#">Power</a> settings menu
System Status	Displays the camera temperature status and a link to the <a href="#">System Status</a> menu
Project Settings	Displays the project status and a link to the <a href="#">Project Settings Menu</a>
Lens	Displays the lens status and a link to the <a href="#">Lens</a> settings menu
Wi-Fi	Displays the communication status and a link to the <a href="#">Wi-Fi</a> settings menu
Maintenance	Displays the Temperature and Exposure calibration, the external connection status, and a link to the <a href="#">Maintenance Menu</a>

## MONITORING TOOLS



Open the Monitoring tools by tapping on the Exposure section of the LCD home page.

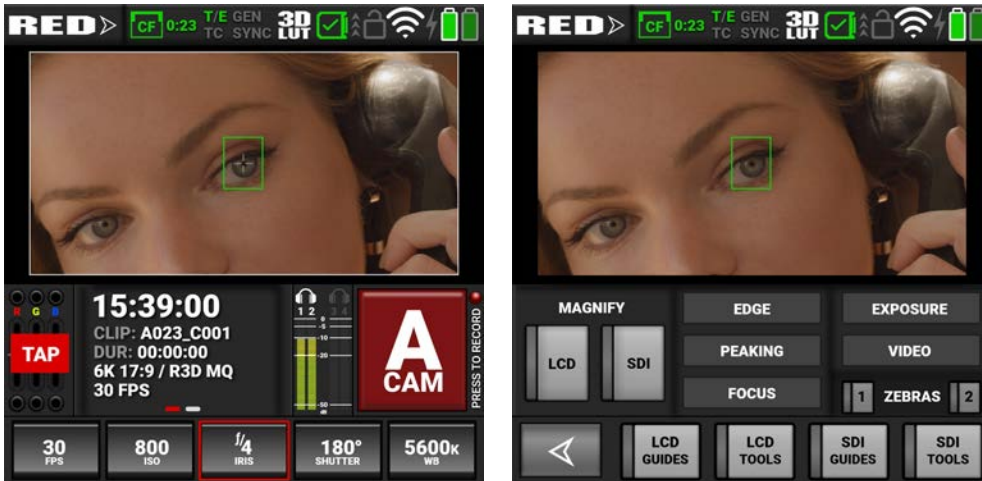

Return to the LCD home page by tapping the arrow button 

The Monitoring tools provide an easy way to toggle many of the monitoring features on and off. When the features are selected, the buttons indicate the selection.



## LCD SWITCHES

The LCD switches allow you to view or hide the enabled LCD monitor Guides and Tools on this LCD screen.

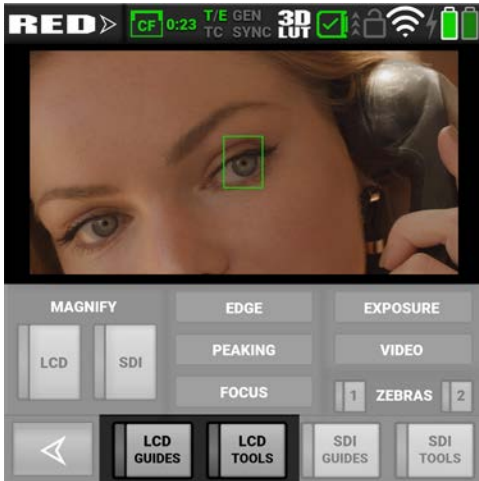

When the switches are selected, the gray bar turns green on the left side of the switch.

The LCD Guides switch displays the Monitoring **Guides** (frame guides and center guide) on the LCD.

The LCD Tools switch displays the Monitoring **Tools** (false color, peaking, zebra) on the LCD and on Live Stream.

## SDI SWITCHES

The SDI switches allow you to view or hide the enabled SDI monitor Guides and Tools on this LCD screen.

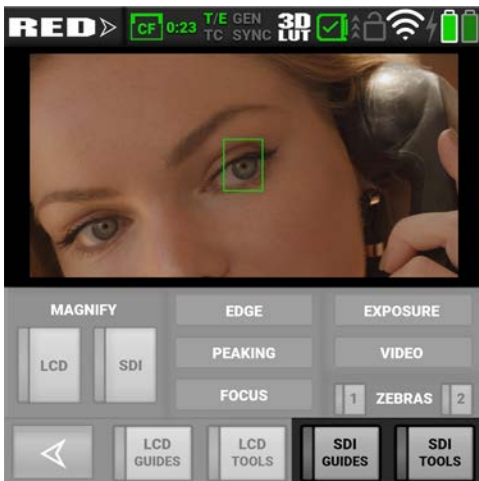

When the switches are selected, the gray bar turns green on the left side of the switch.

The SDI Guides switch displays the Monitoring **Guides** (frame guides and center guide) on the SDI output.

The SDI Tools switch displays the Monitoring **Tools** (false color, peaking, zebra) on the SDI output.

## MAGNIFY

The Magnify section allows you to enable or disable magnification on the camera LCD and the SDI monitor output. When the switches are selected, the gray bar turns green on the left side of the switch.

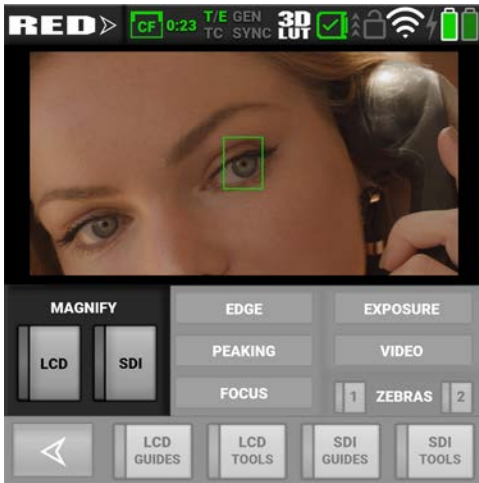

## FOCUS

The Focus section allows you to enable or disable one of the focus tools. The focus tool button you select will turn red.

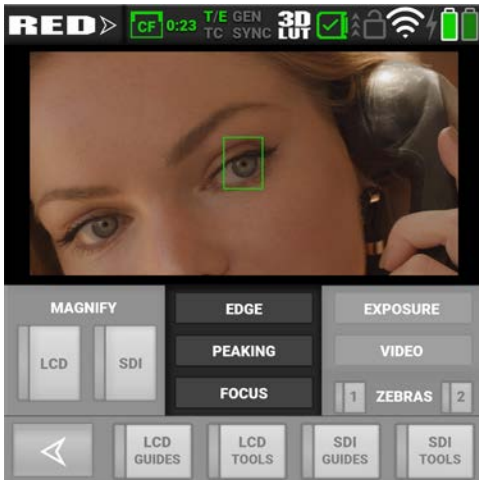

For information about using the Focus tools, refer to [Tools](#).

## EXPOSURE

The Exposure section allows you to enable or disable one of the exposure tools. The Exposure tool button you select will turn red.

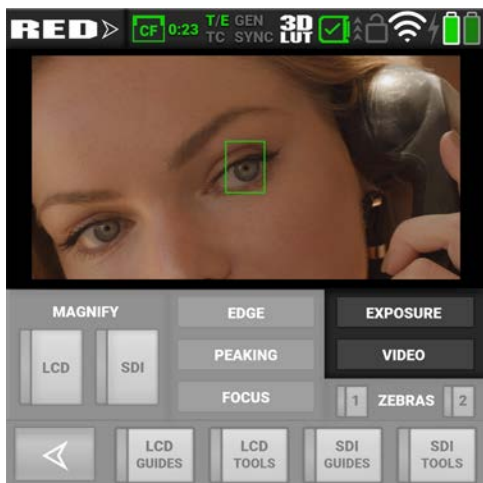

For information about using the Exposure tools, refer to [Tools](#).

## ZEBRA

The Zebra section allows you to enable or disable the Zebra 1 and Zebra 2 modes. When the modes are selected, the gray bar turns green on the left side of the switch.

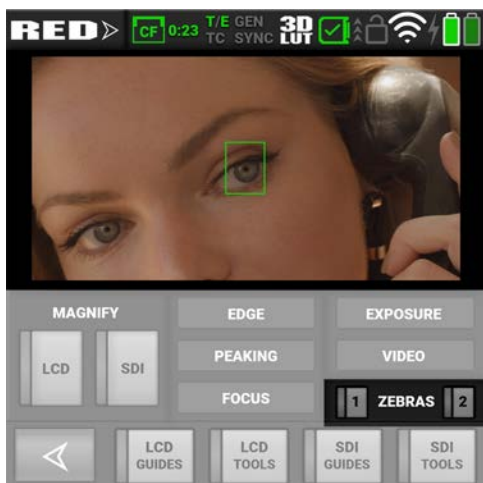

For information about using the two Zebra modes, refer to [Zebra 1](#) and [Zebra 2](#).

## HISTOGRAM

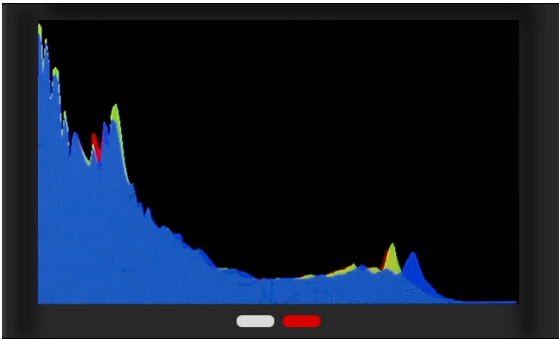

Tap the histogram area to toggle between the Histogram display and the Media display.



The Histogram area of the LCD home page displays an RGB exposure distribution histogram of the final image as it appears on screen. The histogram takes into account exposure elements such as ISO, LUTs, and white balance.

The histogram displays the darkest image elements at the far left, the midtones in the middle, and the lightest image elements at the far right. This provides a quick visual tool you can use to determine your overall image exposure levels.

### Overexposed Example

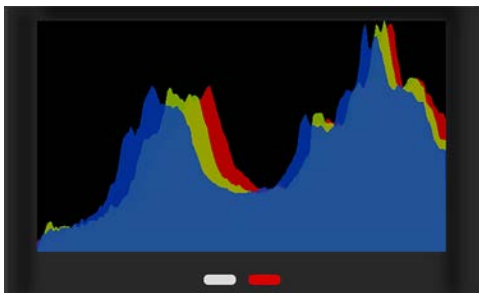

### Underexposed Example

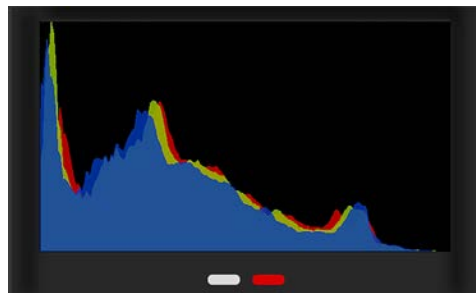

## AUDIO TOOLS



Open the Audio tools by tapping on the Audio section of the LCD home page.

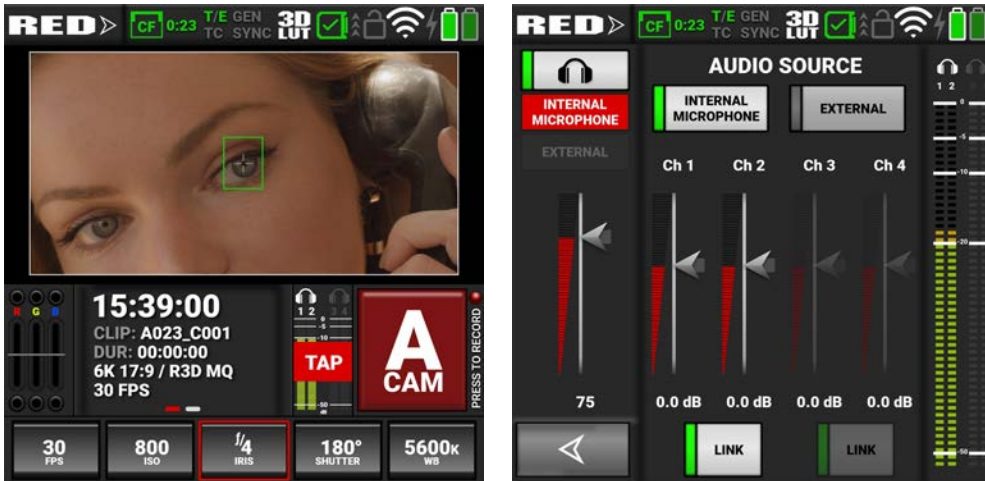

Return to the LCD home page by tapping the arrow .

The Audio tools provide an easy way to control many of the audio features.

When the features are selected, the buttons indicate the selection.

## HEADPHONE

The headphone section allows you to enable/disable the headphone output, to select input from Internal Microphone, or External, and to adjust the headphone volume with a slider.

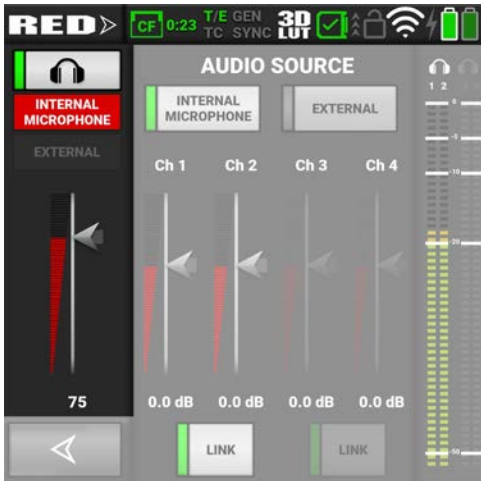

## AUDIO SOURCE

The Audio Source section allows you to select the audio source the camera will record to the clip. You can select Internal Microphone, External, both, or none. Use the sliders to adjust the gain for each channel. You can use the Link button to link channels 1 and 2, or to link channels 3 and 4. This allows you to adjust both of the internal or external channels together.





## AUDIO VU METER

The Audio VU Meter section displays the audio input received by the camera from the four channels.

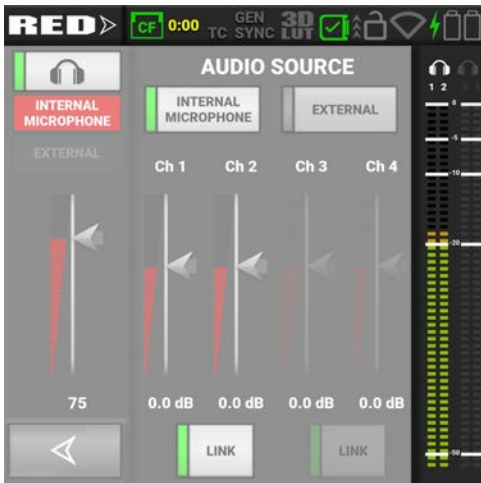

As the input increases, the level indicator changes from green to yellow to orange to red. When the audio input clips, the channel number at the top of the VU meter turns red:

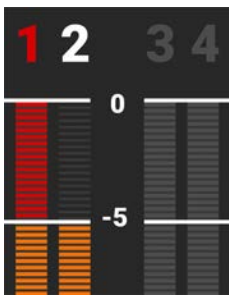

## PLAYBACK

When you press on the Playback button, the LCD Touchscreen displays the Playback screen.



To close the Playback screen, press the Playback button.

**NOTE:** When you open playback, it disables many of the menu settings.

## PLAYBACK SCREEN



The Playback screen displays the clip image along with the following:

- Clip Slider
- RGB Exposure
- Histogram
- Audio VU Meters
- Clip Information
- Playback Screen Buttons

## CLIP SLIDER

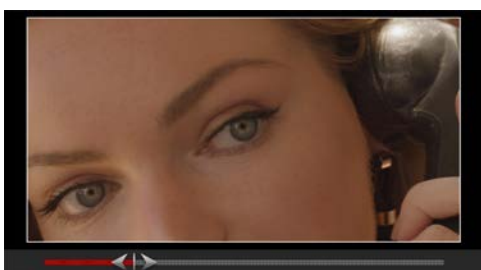

Use your finger to move forward and backward through the frames by swiping the image to the left and the right. The Clip Slider shows where in the timeline the displayed frame is located in the clip.

## RGB EXPOSURE

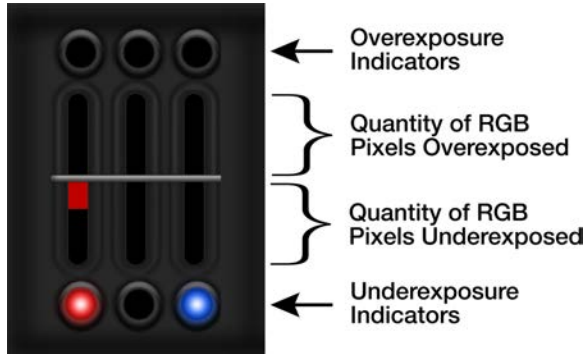

RGB Exposure displays the exposure levels of the separate RGB channels and indicates when a channel is underexposed or overexposed. This meter measures the raw image data regardless of the ISO and LUT settings.

## HISTOGRAM

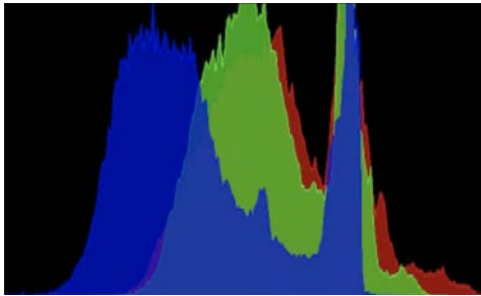

The histogram displays the darkest image elements at the far left, the midtones in the middle, and the lightest image elements at the far right. This gives you a quick way to view your overall image exposure levels.

## AUDIO VU METERS

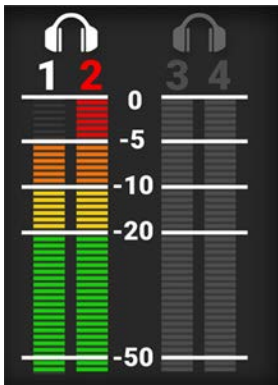

The Audio VU meters display the audio levels in the played clip.

## CLIP INFORMATION

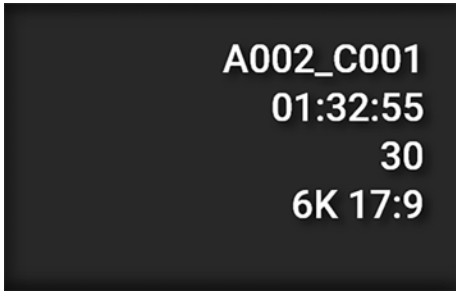

The Clip Information displays the name, duration, time base, and format of the clip.

## PLAYBACK SCREEN BUTTONS

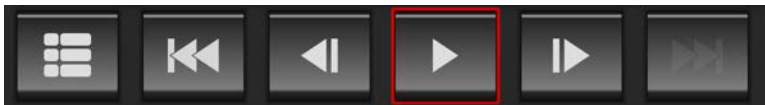

With the Playback screen buttons you can view the Clip list, move one clip back, move one frame back, play/pause, move one frame forward, and move one clip forward.

## CLIP LIST

The Clip List button displays the list of clips recorded on the media card.

Each clip displays the first frame of the clip, the clip information, and the clip file format.



Swipe up and down to scroll through the list of clips. Tap the down arrow to open the clip information screen.

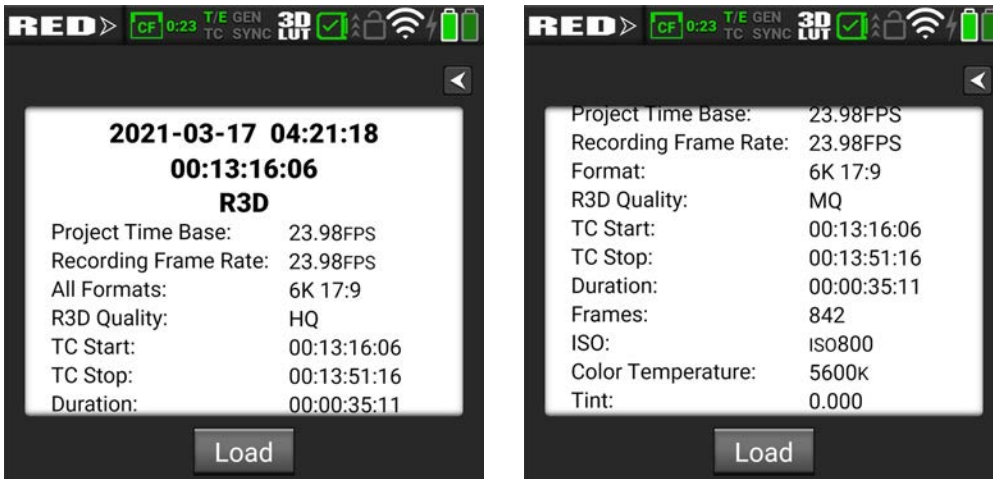

When you tap the Load button, the camera loads the clip to the Playback screen.

## RED CONTROL APP

The RED Control app provides remote and tethered access to the camera from a device. Access is available through Wi-Fi, USB-C, and Ethernet.

The RED Control app is free through the Google Play store and the Apple App store.

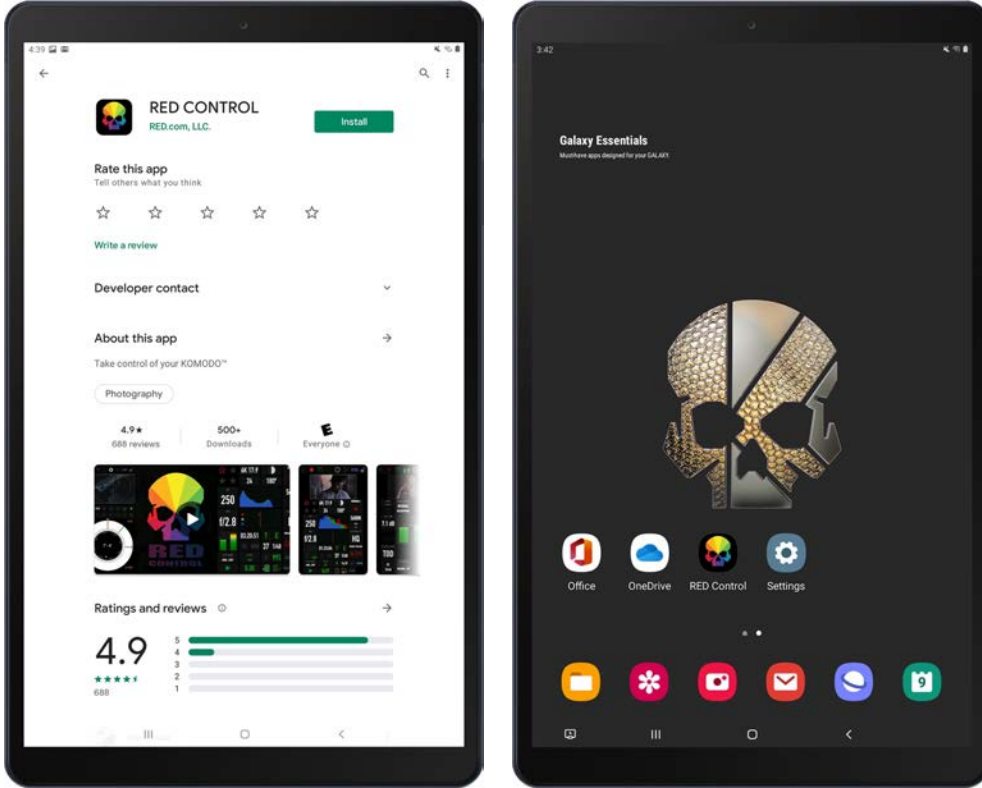

The RED Control app allows you to control all of the KOMODO features while viewing the image.

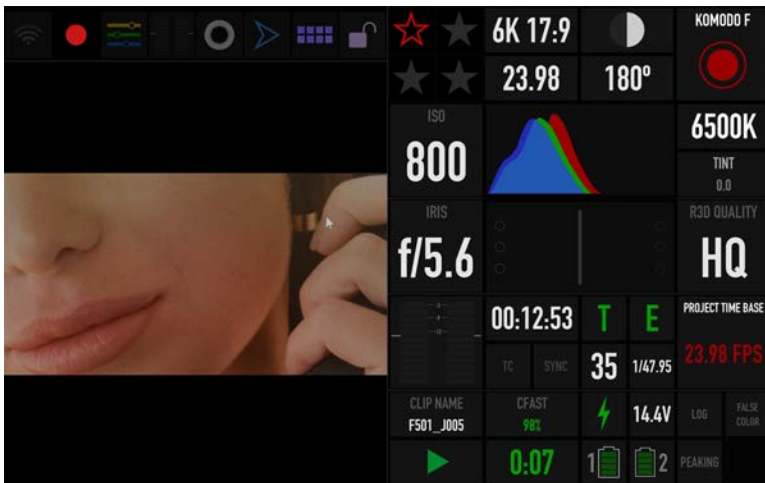

For more information about connecting the camera to RED Control, refer to the How To section ([KOMODO Link Adaptor](#)).



## 4. MENUS

This section describes the menus and sub-menus for the camera. To access the menus, navigate to a menu item from the [LCD Touchscreen](#).

MENUS	DETAILS
<a href="#">Image / LUT Menu</a>	ISO, Shutter, White Balance, Output Color Space, Output Tone Map, Highlight Roll-Off, Display Preset, 3D LUT, CDL, Exposure Adjust
<a href="#">Project Settings Menu</a>	Format, Recording Frame Rate, Project Time Base, File Format, R3D Quality, ProRes Resolution, ProRes Codec, ProRes Color Profile, Pre-Record, Recording Mode, Timelapse, Frame Limit, Slate
<a href="#">Audio / TC Menu</a>	Audio Source, Internal Mic, External Audio, Headphone, Timecode Source, Jam Timecode to TOD, Timecode Display Mode
<a href="#">Monitoring Menu</a>	LCD, SDI, Live Stream, Tools, Guides
<a href="#">Media Menu</a>	Eject, Media Info, Secure Format
<a href="#">Presets Menu</a>	Create Preset, On Media, In Camera
<a href="#">Autofocus - BETA Menu</a>	Enable, Mode, Size, Position, Start AF
<a href="#">Communication Menu</a>	Camera, Wi-Fi, Serial, KOMODO Link Adaptor, FTPS
<a href="#">System Settings Menu</a>	Date / Time, Lens, Power, Indicators, GPO, Status Settings, System Status
<a href="#">Language Menu</a>	English, Chinese, French, German, Japanese, Spanish
<a href="#">Maintenance Menu</a>	Calibrate, Calibration, Save Log, Reset Defaults, Factory Reset, Upgrade

## IMAGE / LUT MENU

The Image / LUT menu contains the settings you use to configure your image.

From the camera LCD touchscreen menu, select Image / LUT:

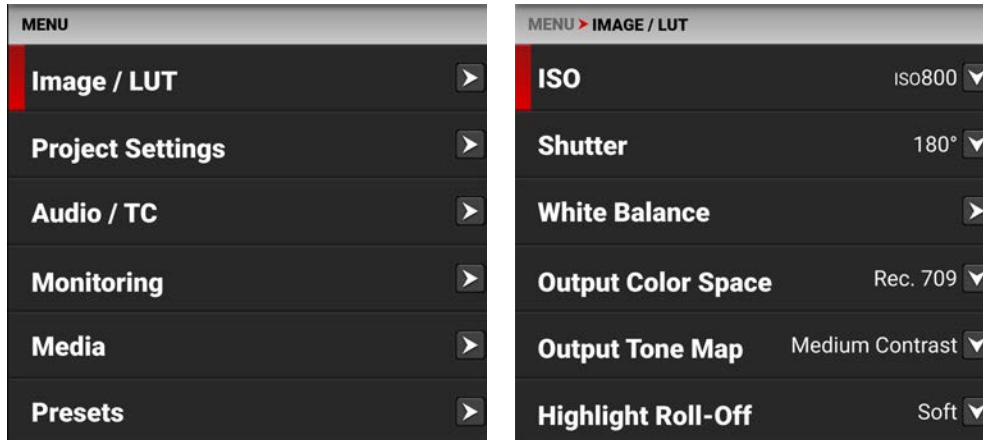

Use the Image / LUT menu to configure the camera's image and lookup table (LUT) settings:

ITEM	DETAILS
ISO	Adjusts the sensitivity of the sensor to light
Shutter	Adjusts the amount of light exposed to the sensor
White Balance	Adjusts the colors to compensate for the light source temperature
Output Color Space	Adjusts on-set working color space
Output Tone Map	Adjusts the image contrast
Highlight Roll-Off	Adjusts image highlight compression
Display Preset	Adjusts on-set working gamma space
3D LUT	Manage the camera's look up tables (LUTs).
CDL	Opens the Color Decision List (CDL) menu
Exposure Adjust	Manually fine-tunes the midtone exposure level

## ISO

Use the ISO setting to adjust the image's exposure in the monitoring path.

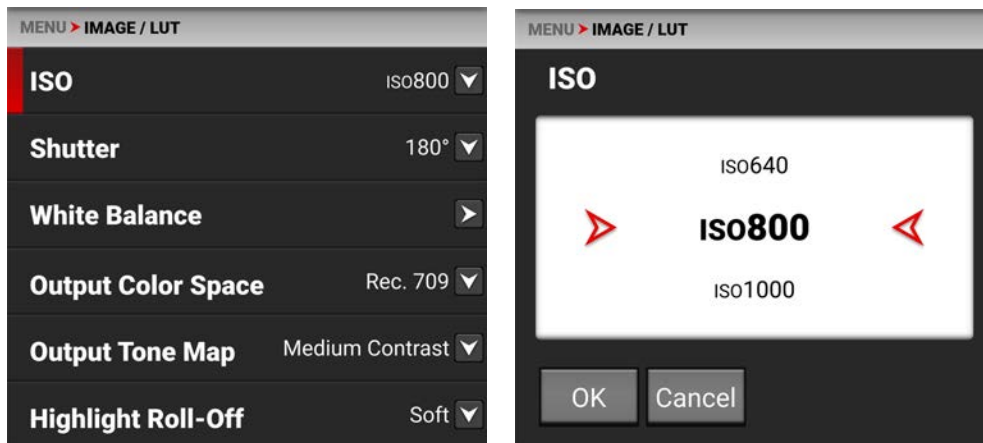

The ISO range is ISO 250 to ISO 12,800. The default ISO is ISO 800.

Higher ISO values create brighter images in the monitor path, and lower ISO values create darker images in the monitor path.

When you record using the R3D **File Format**, the ISO settings are stored as metadata and you can adjust them later in post-processing with REDCINE-X PRO or other editing tools that support R3D files.

RED recommends setting the ISO to the default of 800, then adjusting the aperture, lighting, and ND filters to match. The ISO can later be adjusted for fine-tuning.

## SHUTTER

Use Shutter to select the amount of time the sensor is exposed to light per frame (shutter speed / shutter angle). You can change the shutter settings while recording.

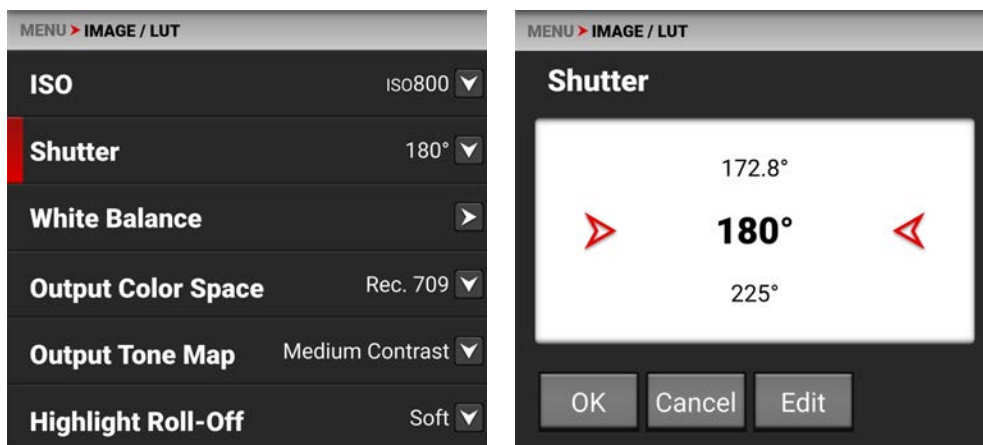

You can switch between angle and time by using the **Status Settings**.

Decreasing shutter speed increases the amount of time that light hits the sensor, which increases exposure and motion blur of moving objects. Increasing shutter speed decreases the amount of time that light hits the sensor, which decreases exposure and motion blur of moving objects.

## SHUTTER ANGLE

Enter the exposure value as a shutter angle (xx°). The shutter angle range is 0° to 360°. The default shutter angle is 180°. Click Edit to enter an exact shutter angle or shutter speed.



## EXPOSURE CONVERSIONS

The table below lists common shutter angle and shutter speed equivalents. The calculations in the table use a recording frame rate of 23.98 fps.

SHUTTER ANGLE (°)	SHUTTER SPEED (1/XX SEC)	SHUTTER ANGLE (°)	SHUTTER SPEED (1/XX SEC)
360°	1/23.98	105°	1/82.20
288°	1/29.97	90°	1/95.90
270°	1/31.97	72°	1/119.88
240°	1/35.96	45°	1/191.81
225°	1/38.36	22.5°	1/383.62
180°	1/47.95	11.2°	1/770.66
172.8°	1/49.95	8.6°	1/1003.65
144°	1/59.94	4°	1/2157.84
135°	1/63.95	1°	1/8000 (max)
120°	1/71.93		

## SHUTTER SPEED

Enter the exposure value as a shutter speed (1/xx sec).

The slowest shutter speed is 1/(recording frame rate). For example, if the recording frame rate is 23.98 fps, the slowest available shutter speed is 1/23.98 sec. The fastest shutter speed is 1/8000 sec. The default shutter speed is 1/47.95 sec.

### CONVERT SHUTTER SPEED TO SHUTTER ANGLE

Shutter Angle = (Shutter Speed x Frame Rate x 360)

Example:  $(1/47.95 \times 23.98 \times 360) = 180$

### CONVERT SHUTTER ANGLE TO SHUTTER SPEED

Shutter Speed =  $1 / (\text{Frame Rate} \times 360 / \text{Angle})$

Example:  $1 / (23.98 \times 360 / 180) = 1/47.95$

## WHITE BALANCE

Use the White Balance menu to adjust the **Color Temperature**, **Color Temperature Presets**, **Tint** and execute the **Auto White Balance**.

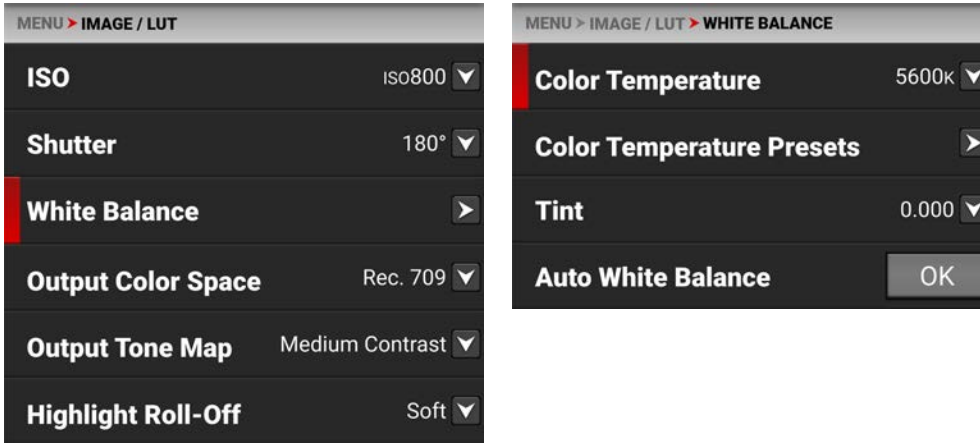

When shooting in R3D format, the camera stores white balance as metadata, which you can adjust non-destructively in post-production after filming.

Use the White Balance menu to configure the color temperature and tint settings for your image:

ITEMS	DETAILS
<b>Color Temperature</b>	Image color temperature correction
<b>Color Temperature Presets</b>	Tap a button to select a preset color temperature
<b>Tint</b>	Adjust magenta-green color component
<b>Auto White Balance</b>	The camera automatically sets the color temperature and tint

## COLOR TEMPERATURE

Use Color Temperature to adjust the image's color temperature in Kelvin units (K) or by selecting presets.

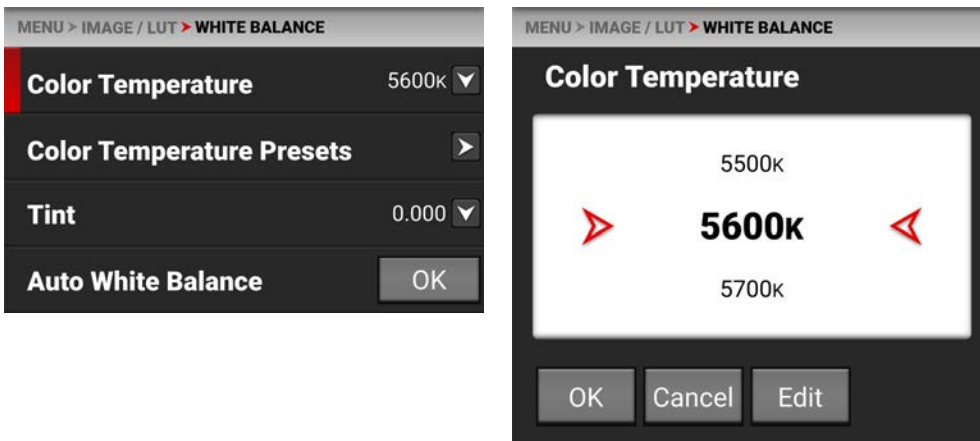

When the image's light source color temperature is warm, you can compensate by setting the camera to a warmer color temperature. When the image's light source color temperature is cool, you can compensate by setting the camera to a cooler temperature.

The color temperature range is 1,700 K to 10,000 K. The default color temperature is 5600 K.

When the White Balance List Mode (refer to [Status Settings](#)) is set to Presets, the Color Temperature menu list uses the preset temperatures instead of the Kelvin temperatures.

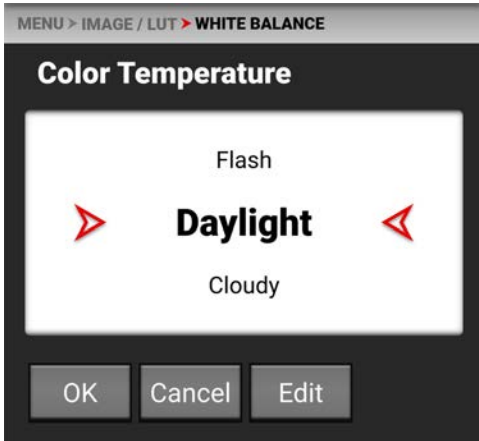

## COLOR TEMPERATURE PRESETS

Use Color Temperature Presets to select a pre-configured color temperature.

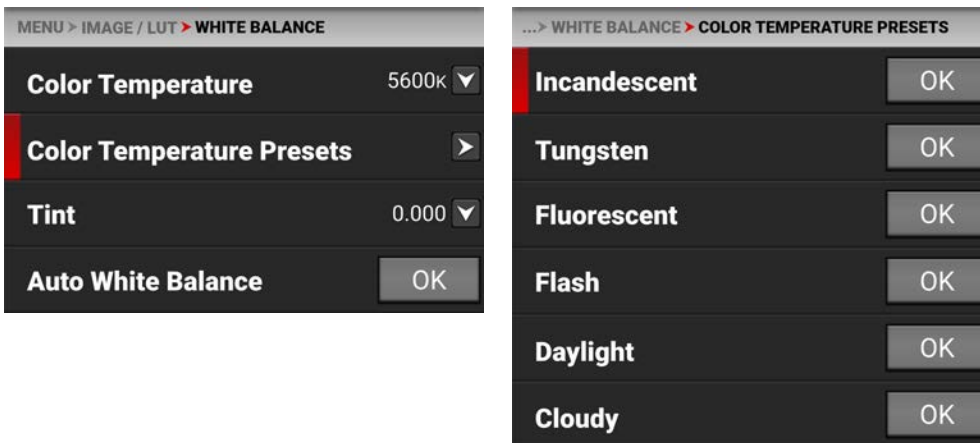

The color temperature presets you can select include:

ITEMS	DETAILS	ITEMS	DETAILS
Incandescent	2800 K	Daylight	5600 K
Tungsten	3200 K	Cloudy	7000 K
Fluorescent	4500 K	Shade	8000 K
Flash	5500 K		

## TINT

Use Tint to adjust the image's color tint.

Color temperature calculations assume a pure light source that may not be true in the specific scene the camera is imaging. To compensate for any residual colorcast, the Tint setting adjusts the RGB color balance with a compensating magenta-green color component.

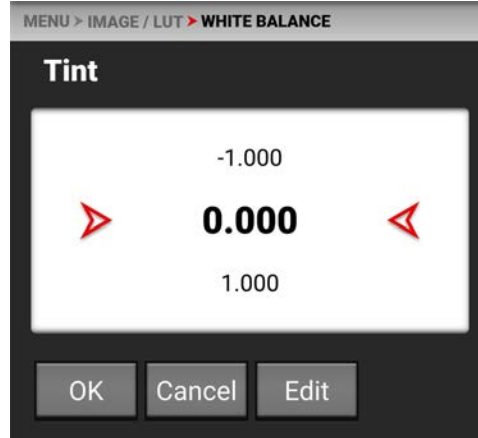
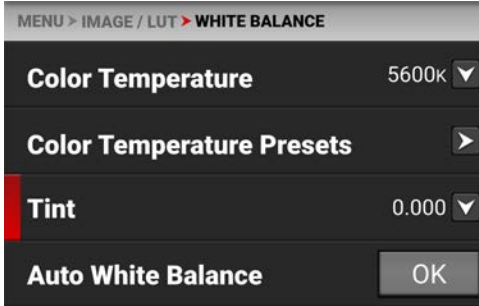

Tint range is -100.000 to 100.000. The default Tint setting is 0.000.

Use Edit to open the keypad screen where you can enter a specific Tint value.

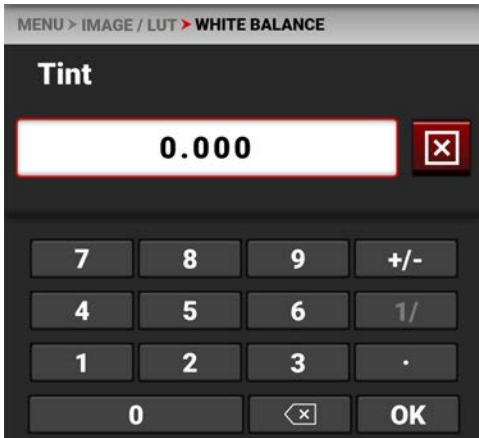



## AUTO WHITE BALANCE

Use Auto White Balance to use the camera's automatic white balance adjustment.

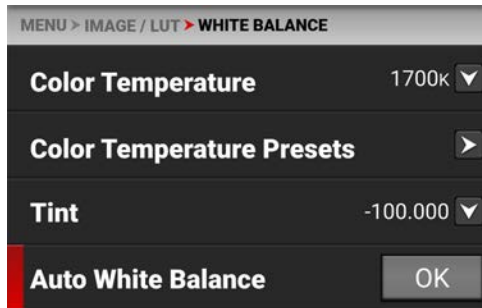

When shooting in R3D format, the camera stores white balance as metadata, which you can adjust non-destructively in post-production after filming.

To use Auto White Balance:

1. Place an 18% gray chart in the center of the image under the correct exposure.
2. From the **White Balance** menu tap OK next to **Auto White Balance**.
3. The camera automatically sets the color temperature and tint settings.

**NOTE:** Place the chart in the same location as your subject, and illuminate it with the same lighting.

## OUTPUT COLOR SPACE

Use Output Color Space to select the desired Color Space to use when displaying the camera output.

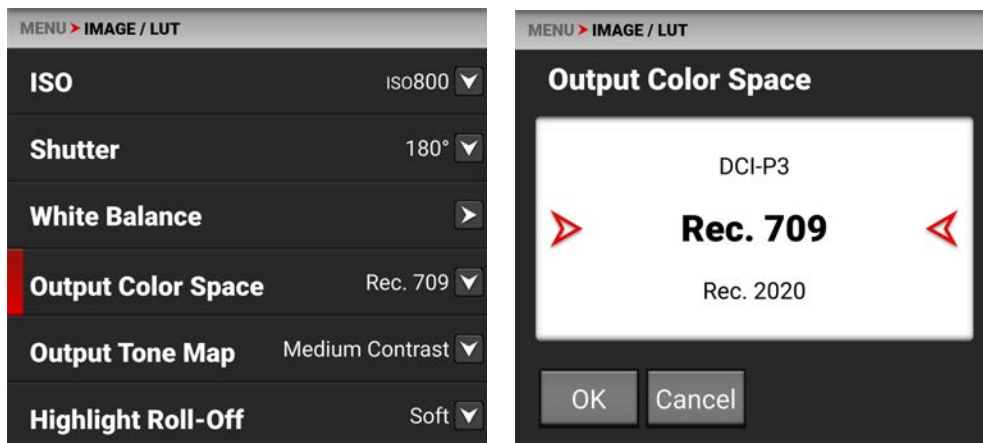

The Output Color Space selections include:

- DCI-P3 - Digital Cinema Initiatives theater projector standard color space
- Rec. 709 - Standard Color Space for HDTV (default)
- Rec. 2020 - Standard Color Space for UHD and HDR
- REDWideGamutRGB - Color space encompassing all of the colors the RED camera can generate without clipping.

## OUTPUT TONE MAP

Use Output Tone Map to adjust the image contrast when displaying the camera output.

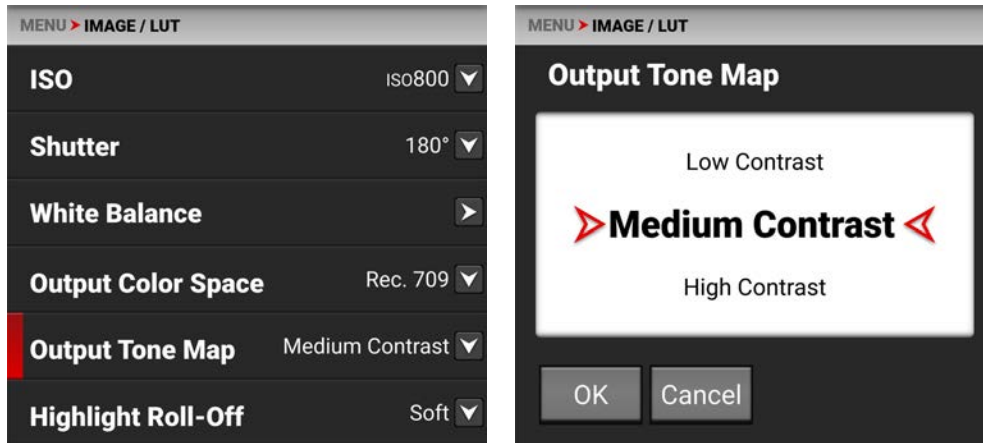

When shooting in R3D format, the camera stores this as metadata, which you can adjust non-destructively in post-production after filming.

The Output Tone Map selections include:

- Low Contrast - Low contrast is applied to the image
- Medium Contrast - Medium contrast is applied to the image (default)
- High Contrast - High contrast is applied to the image
- None - No contrast is applied to the image

## HIGHLIGHT ROLL-OFF

Use Highlight Roll-Off to select the desired highlight compression to use when displaying the camera output.

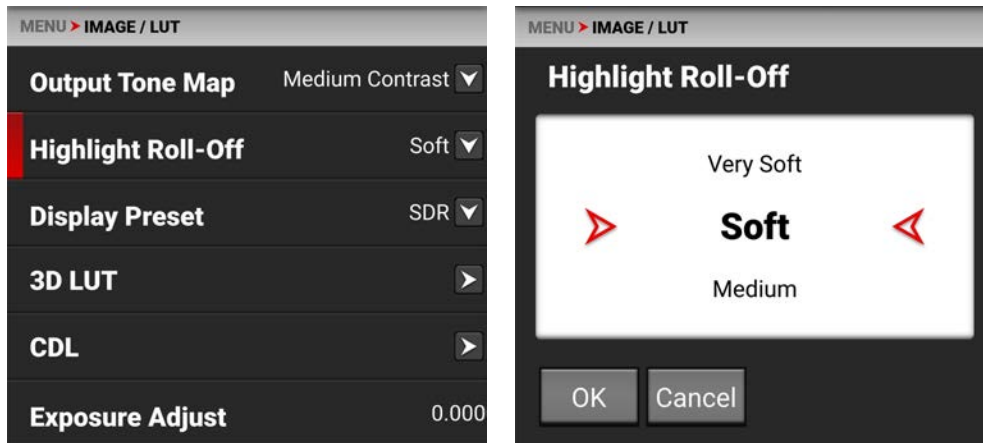

When shooting in R3D format, the camera stores this as metadata, which you can adjust non-destructively in post-production after filming.

The Highlight Roll-Off selections include:

- Very Soft - The lightest compression is applied to the image highlights
- Soft - Soft compression is applied to the image highlights (default)
- Medium - Medium compression is applied to the image highlights
- Hard - The highest compression is applied to the image highlights
- None - Nothing is applied to the image highlights

## DISPLAY PRESET

Use Display Preset to select the gamma of the displayed preview image:

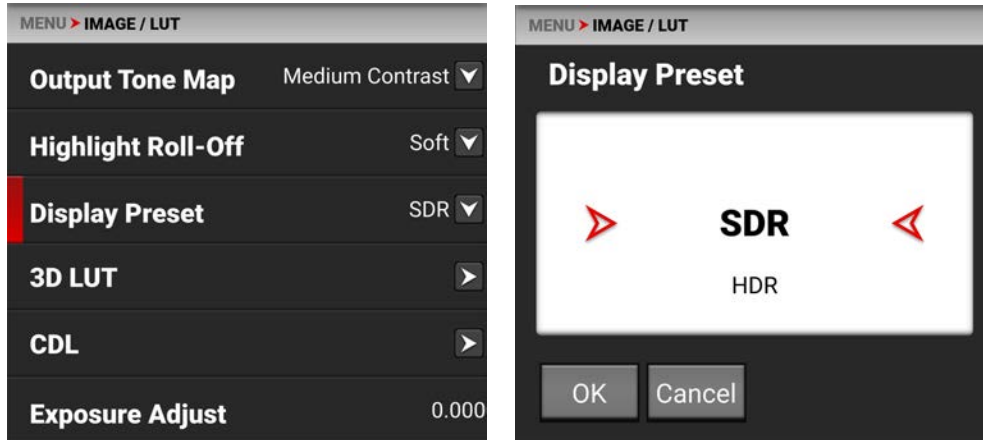

When shooting in R3D format, the camera stores this as metadata, which you can adjust non-destructively in post-production after filming.

The Display Preset allows you to select the gamma for the camera preview and monitor output.

Each monitor is designed to display using a specific gamma. Most monitors use SDR. However, some support HDR and HLG gamma signals. Select the display preset that works best with your monitor.

The selections are:

- SDR - **Standard Dynamic Range** (default)
- HDR - **High Dynamic Range**
- HLG - **Hybrid Log-Gamma**

## STANDARD DYNAMIC RANGE

Standard-dynamic-range (SDR) video describes images or video using a conventional gamma curve signal. The conventional gamma curve is based on the limits of the cathode ray tube which allowed for a maximum luminance of 100 candelas per square meter (cd/m<sup>2</sup>).

## HIGH DYNAMIC RANGE

High Dynamic Range (HDR) images are recorded using the SMPTE-2084 PQ curve. This technology captures and outputs a greater range of luminance than images recorded using Standard Dynamic Range (SDR) methods.

## HYBRID LOG-GAMMA

Hybrid Log-Gamma (HLG) delivers HDR resolution without the need for metadata. This allows HLG to display well on SDR and HDR monitors.

### BACKGROUND

NHK and the BBC developed HLG in a joint effort to create a more compatible signal for a wide variety of television sets.

Hybrid Log-Gamma is an open-source standard HDR (High Dynamic Range) video format. Video dynamic range is the measurement between the brightness between black and white (luminosity).

Many monitors offer HDR. However, unlike resolution parameters (1080p, 4K, etc.), HDR is related to luminosity. Luminosity can vary between how an image is captured on a camera and how the image is broadcast to a monitor.

HDR, using Perceptual Quantizer (PQ), sends a signal along with metadata. This metadata is read by the monitor which then displays the signal using the luminosity information supplied by the metadata.

HLG sends a combination (hybrid) of the normal Gamma curve for light coding and a logarithmic curve to deliver the HDR aspects of the signal.

## 3D LUT

Use the 3D LUT menu to apply and manage the camera's Look-Up Tables (LUTs).

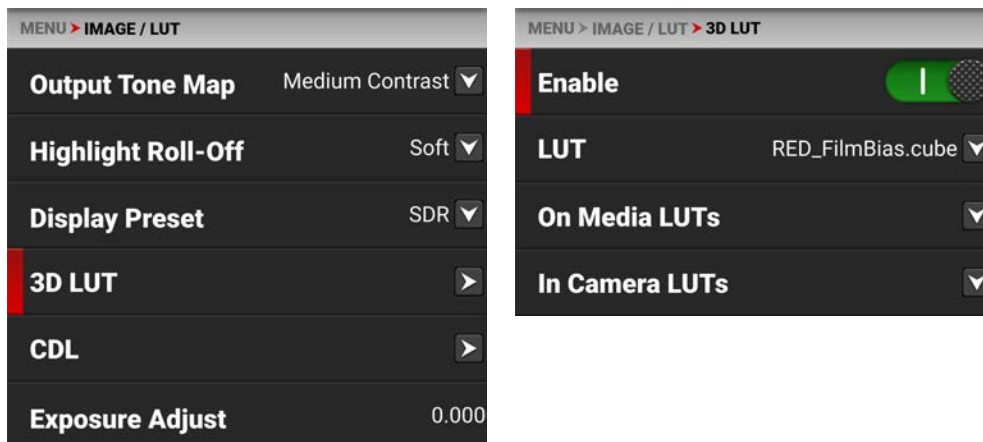

## SELECT LUT

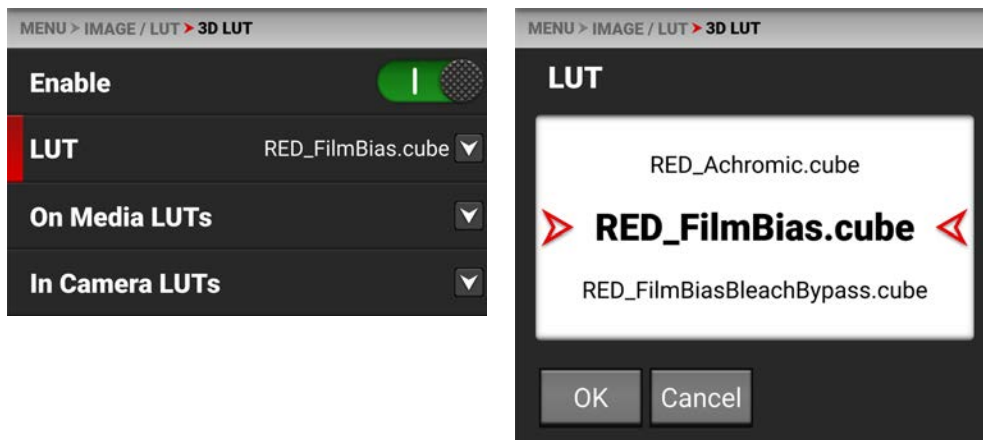

When you are recording in the ProRes format, you can choose to irreversibly encode (bake) the 3D LUT into the recorded file. For more information, refer to the [ProRes Color Profile](#) section.

When you are recording in the R3D format, this LUT will be saved along with each clip on which it is activated during recording. The LUT is non-destructive, and it is reversible, when recording in the R3D format.

To apply a 3D LUT, follow the instructions below:

1. Go to **MENU > IMAGE / LUT > 3D LUT > LUT**.
2. Select a LUT from the **LUT** list.

## ON MEDIA LUTS

To import 3D LUTs from media, go to **MENU > IMAGE / LUT > 3D LUT > On Media LUTs**.

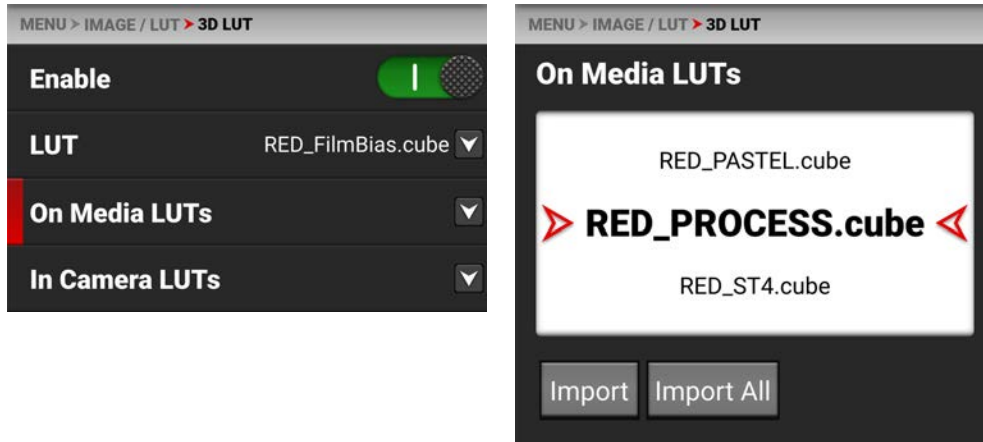

3D LUTs can be imported from media to the camera. When importing 3D LUTs from media to the camera, the 3D LUTs must be saved on the root path of your media, in a folder titled "luts".

From On Media LUTs, you can:

- Import the selected 3D LUT from the media to the camera
- Import all 3D LUTs from the media to the camera.

## IN CAMERA LUTS

To export and delete 3D LUTs stored in the camera, go to **MENU > IMAGE / LUT > 3D LUT > In Camera LUTs**.

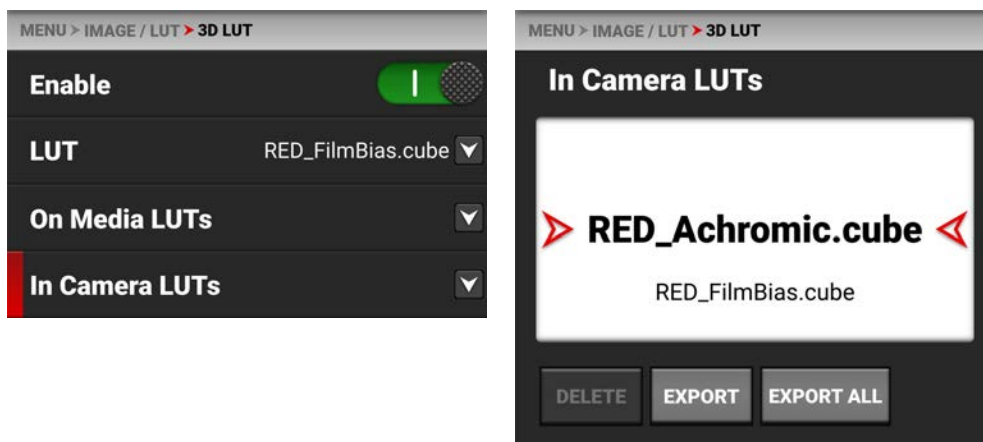

You can export 3D LUTs stored on the camera, to media, to use on other cameras. When you export 3D LUTs from the camera to media, the 3D LUTs are saved to a folder on the media called “luts.”

**NOTE:** When a LUT is active during record, it will automatically be saved along with the recorded clip.

From In Camera LUTs you can:

- Delete a selected 3D LUT from the camera
- Export a selected 3D LUT from the camera to the media
- Export all 3D LUTs from the camera to the media.

## CDL

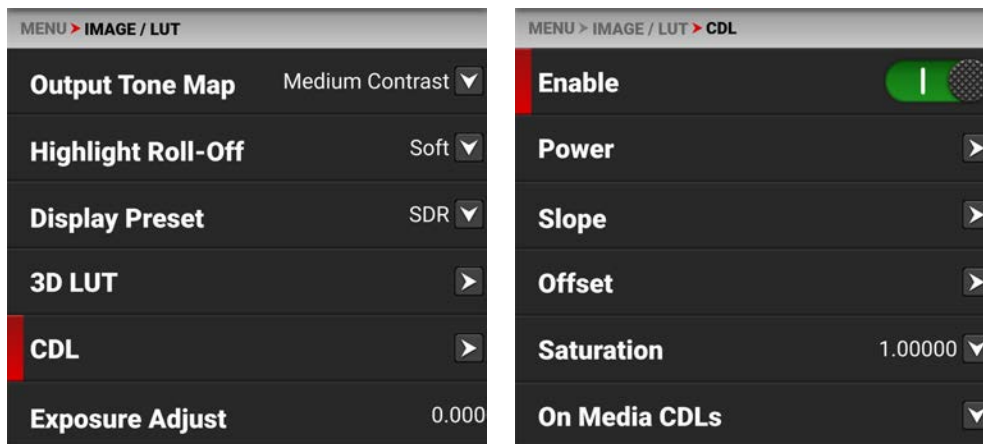

The Color Decision List (CDL) allows you define the look of the camera's colors in your project.

Use the CDL menu to:

- Enable the CDLs
- Configure **CDL Power**
- Configure **CDL Slope**
- Configure **CDL Offset**
- Configure **CDL Saturation**

## MANAGE CDLS

Use the CDLs menu to import and export CDLs.

CDLs can be stored on the camera or transferred to media to be shared with other cameras. When exporting CDLs from camera to media, the CDLs are saved to a folder on the media called “cdls”. When importing CDLs from media to the camera, the CDLs must be stored on the media in a folder called “cdls.”

**NOTE:** When you record with a CDL in both ProRes and R3D formats, the camera automatically saves the CDL together with the clip.

To export selected CDLs from the camera to the media, refer to the **In Camera CDLs** section.

To import selected CDLs from the media to the camera, refer to the **On Media CDL** section.

## CDL OVERVIEW

A Color Decision List (CDL) is a metadata file format developed by the American Society of Cinematographers (ASC) to exchange standard color correction information between post production tools. This non-destructive color adjustment layer simplifies the versioning of looks by updating simple metadata without the need to re-transfer the image data.

CDLs are very common in VFX workflows because the VFX artist needs both the ungraded shot and the intended look. The ungraded shot allows the artist to comp in truly linear light, and the intended look is needed to confirm that the individual plates still hold together after the grade is applied.

## SLOPE, OFFSET AND POWER

The three CDL tone curve parameters are Slope, Offset and Power. These algorithms allow the camera to modify the recorded image.

- Slope multiplies the incoming data
- Offset is sum of the incoming data
- Power is a power function to the incoming data

These three relate to Gain, Lift, and Gamma in the following ways:

- Slope = Gain  
Gain Adjusts highlights.
- Offset = Lift  
Lift Increases the value of dark colors.
- Power = Gamma  
Gamma adjusts midtones.

These three relate to each other in the following ways:

Slope= input x slope

Offset= (input x slope) + offset

Power= ((input x slope) + offset) ^ power

The formula for ASC CDL color correction is:

$$out = ((i \times s) + o)^p$$

where

*out* is the color graded pixel code value

*i* is the input pixel code value (0=black, 1=white)

*s* is slope (any number 0 or greater, nominal value is 1.0)

*o* is offset (any number, nominal value is 0)

*p* is power (any number greater than 0, nominal value is 1.0)

The formula is applied to the three color values for each pixel using the corresponding slope, offset, and power numbers for each color channel.

## SATURATION

A fourth parameter “Saturation” is achieved by converting the *out* data in a Luma and Chroma component. The Chroma Signal is then multiplied by the “Saturation” parameter.



## FILM GRADE AND VIDEO GRADE

With Slope and Offset you can produce both a Film Grade “Exposure” and “Contrast” and a Video Grade “Lift” and “Gain”.

- Exposure is achieved by Offset
- Contrast is achieved by a combination of Offset and Slope
- Gain is achieved by Slope
- Lift is achieved by a combination of Offset and Slope
- Gamma is achieved by Power

## CDL POWER

The CDL defines the image settings for the red, green, and blue channel. The three CDL tone curve parameters are Slope, Offset and Power. These algorithms allow the camera to modify the recorded image. The CDL Power settings control the power of the Red, Green, Blue, color data.

The Camera LCD Menu for CDL Power:

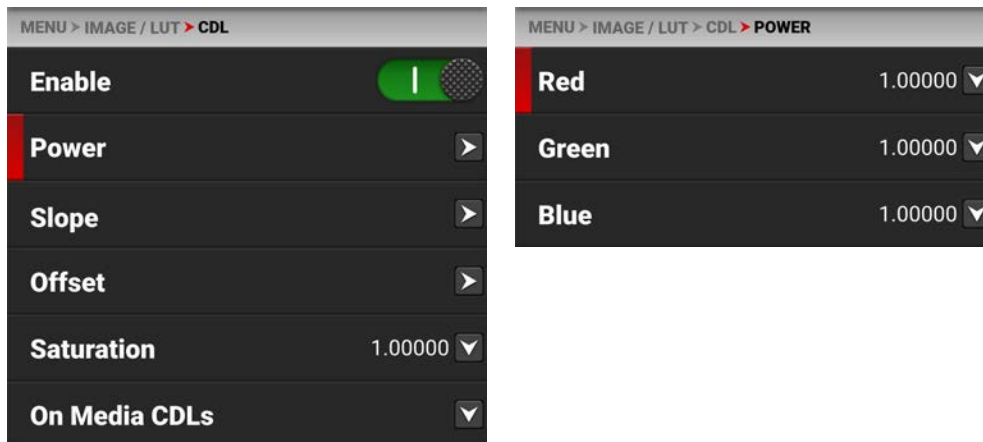

Use the CDL Power menu to adjust the power of the Red, Green, and Blue CDL data.

## CDL POWER SETTINGS

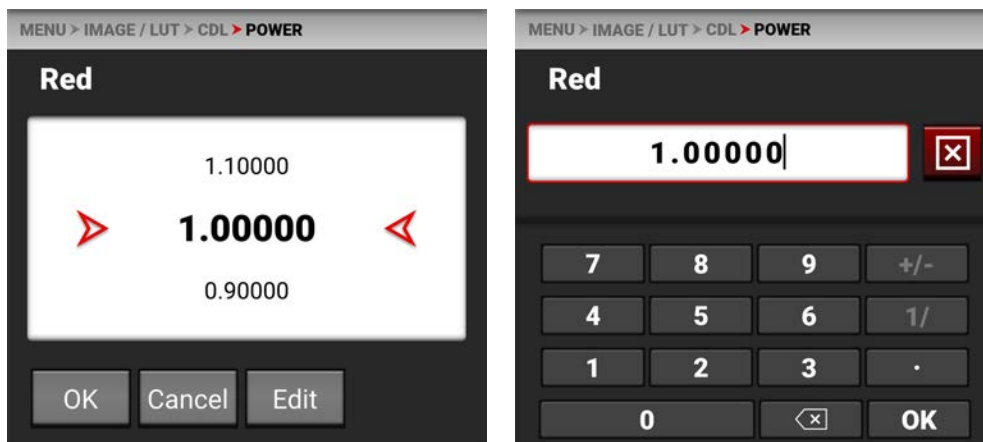

The CDL Power settings range from 0.00000 to 4.00000. The default CDL Power setting for each color is 1.00000. The Edit button opens the keypad where you can enter a specific CDL Power value.

## CDL SLOPE

The CDL defines the image settings for the red, green, and blue channel. The three CDL tone curve parameters are Slope, Offset and Power. These algorithms allow the camera to modify the recorded image. The CDL Slope settings multiply the incoming RGB data.

The Camera LCD Menu for CDL Slope:

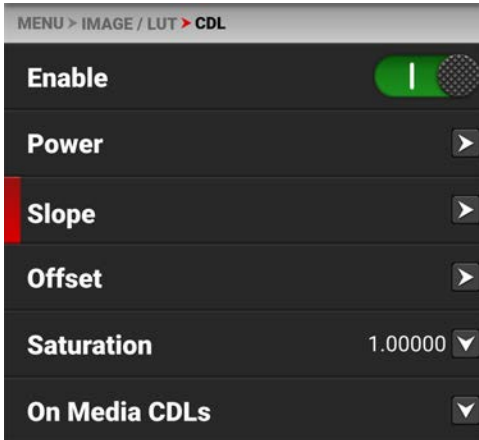

Use the CDL Slope menu to set the slope of the red, green, and blue signals.

### SLOPE SETTINGS

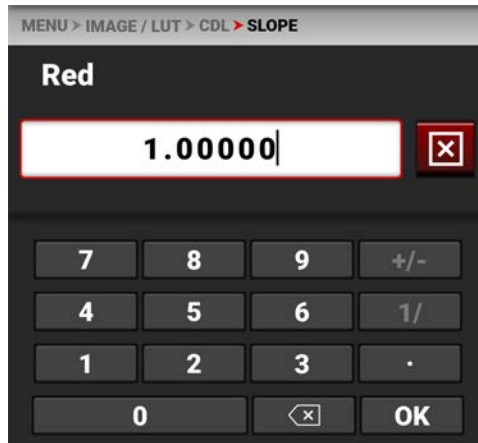
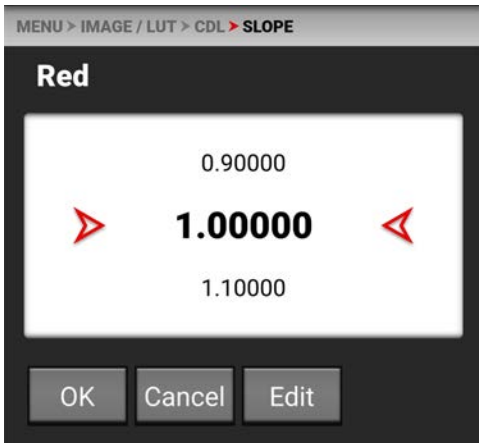

The CDL Slope settings range from 0.00000 to 2.00000. The default CDL Slope settings are 1.00000. The Edit button opens a keypad where you can enter a specific CDL Slope value.

## CDL OFFSET

The CDL defines the image settings for the red, green, and blue channel. The three CDL tone curve parameters are Slope, Offset and Power. These algorithms allow the camera to modify the recorded image. The CDL Offset settings control the offset of the RGB color data.

The Camera LCD Menu for CDL Offset:

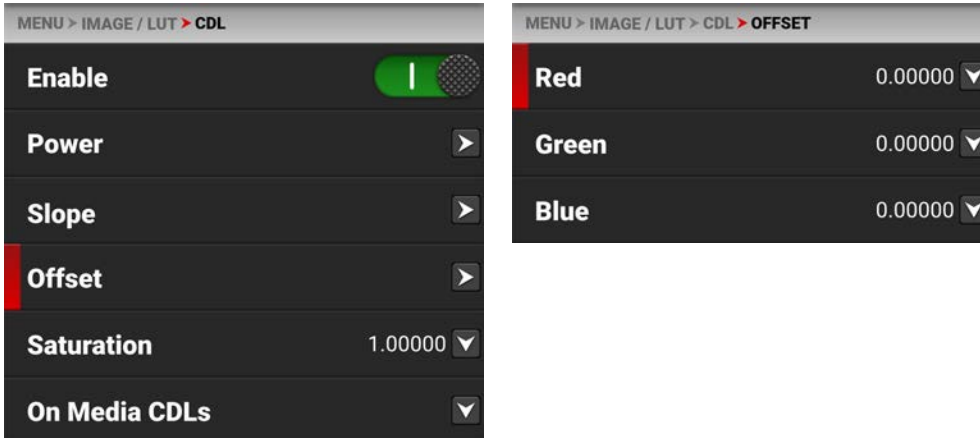

Use the CDL Offset menu to adjust the offset of the **CDL Slope** for the Red, Green, and Blue CDL data.

## RED GREEN AND BLUE OFFSETS

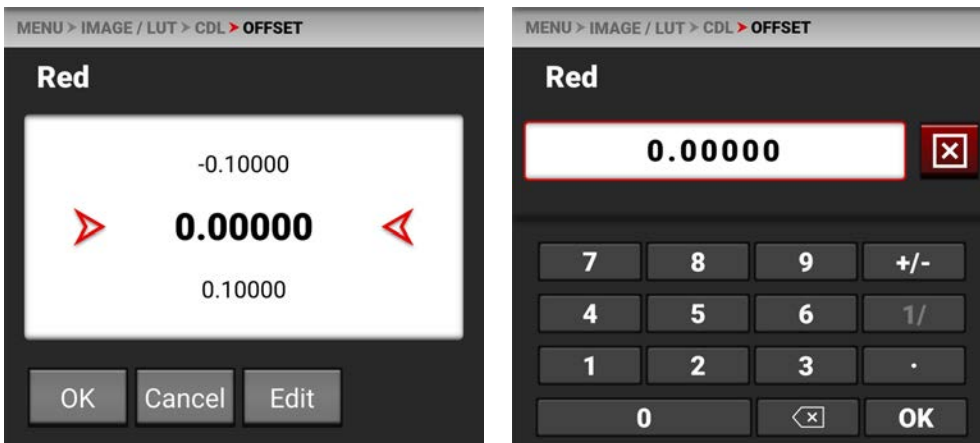

These CDL Offset settings range from -1.00000 to 1.00000. The default CDL Offset setting for each is 0.00000. The Edit button opens the keypad, where you can enter a specific CDL Offset value.

## CDL SATURATION

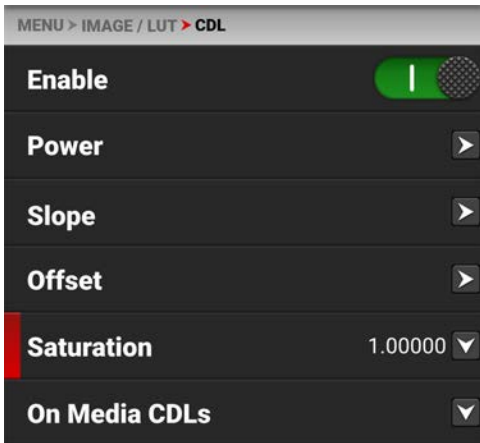

The CDL defines the image settings for the red, green, and blue channel. The three CDL tone curve parameters are Slope, Offset and Power. These algorithms allow the camera to modify the recorded image. The CDL Saturation settings control the intensity of the color data.

Use the CDL Saturation menu to adjust the intensity of the image color.

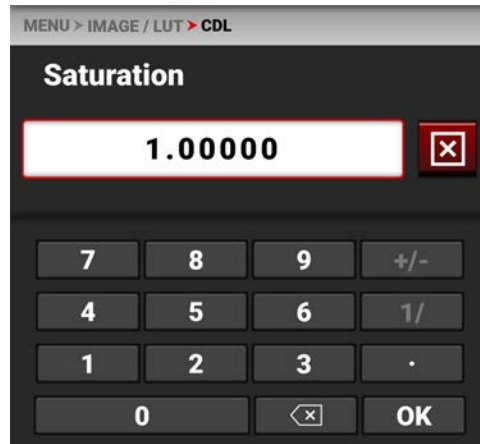
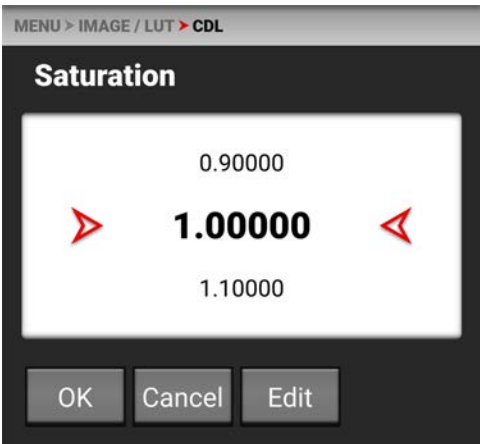

The CDL Saturation settings range from 0.00000 to 4.00000. The default CDL Saturation setting is 1.00000. The Edit button opens a keypad where you can enter a specific CDL Saturation value.

## ON MEDIA CDL

Use On Media CDLs to copy CDLs stored on the media and store them on the camera.

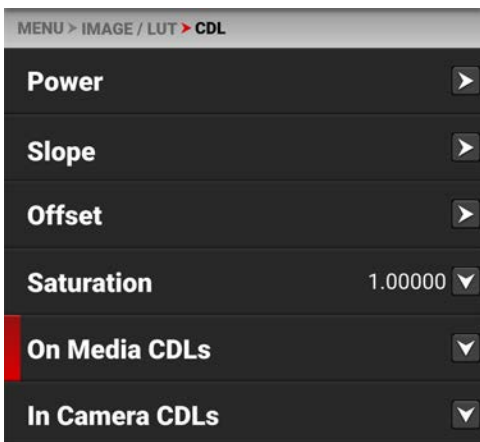

CDLs can be imported from media to the camera. When importing CDLs from media to the camera, the CDLs are saved to a folder on the camera called "cdls".

From On Media CDLs you can import the selected CDL from the media to the camera or import all of the CDLs from the media to the camera.

## IN CAMERA CDLS

Use In Camera CDLs to copy CDLs stored on the camera and store them on the media. You can also select which stored CDLs you want the camera to use.

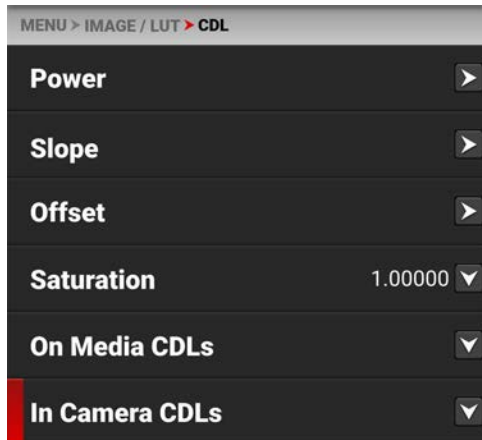

CDLs can be exported from the camera to the media. When exporting CDLs from camera to the media, the CDLs are saved to a folder on the media called “cdls.”

From In Camera CDLs you can apply the selected CDL to the camera, delete the selected CDL from the camera, export the selected CDL from the camera to the media, or export all of the CDLs from the camera to the media

## EXPOSURE ADJUST

Use Exposure Adjust to manually fine-tune the midtone exposure level.

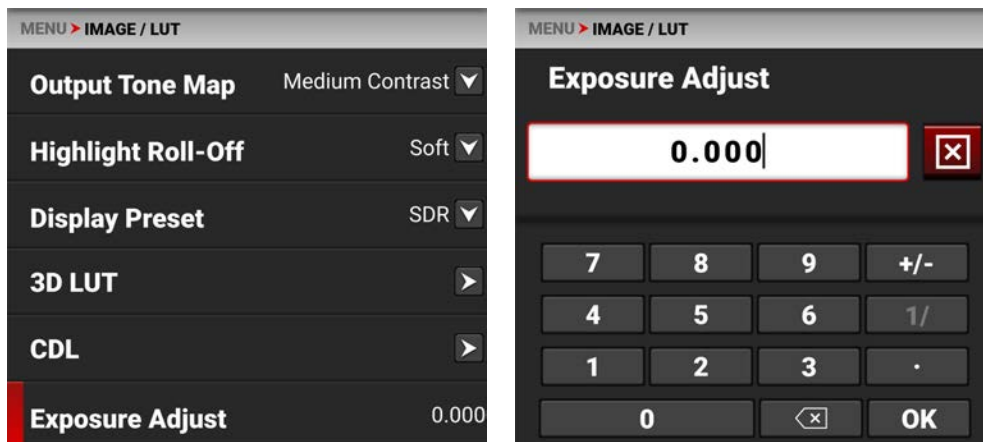

The Exposure Adjust range is –8.000 to 8.000. The default is 0.000.

Exposure Adjust allows you to adjust the midtone exposure levels while preserving the highlights and shadows, even when changed substantially. The Exposure Adjust setting is expressed in terms of relative exposure value (EV), where each unit represents a 1-stop change in midtone exposure level.

## PROJECT SETTINGS MENU

The Project Settings menu contains the settings you use to enter your cinematography project information.

From the camera LCD touchscreen menu, tap Project Settings:

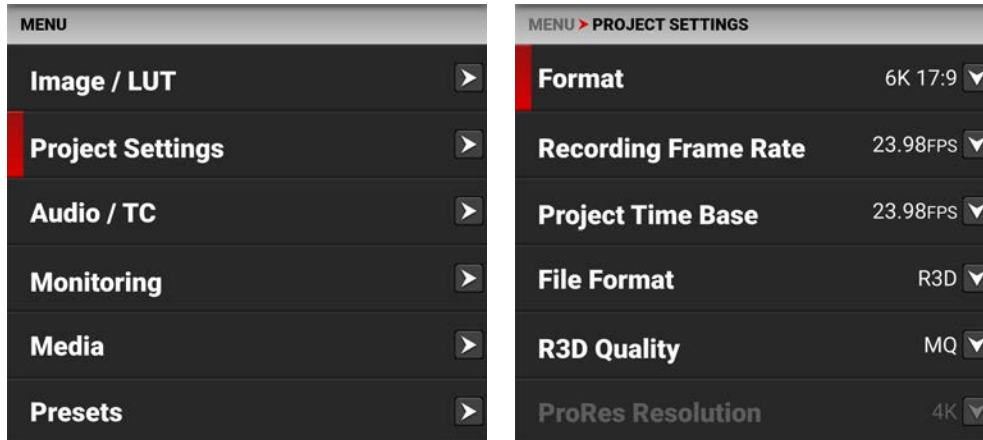

Use the Project Settings menu to configure the settings for your cinematography project:

ITEMS	DETAILS
Format	Size of the area captured by the sensor
Recording Frame Rate	Frames recorded per second
Project Time Base	Image playback rate
File Format	R3D or ProRes file formats
R3D Quality	Compression level of the recorded image file
ProRes Resolution	Resolution of the recorded ProRes image file
ProRes Codec	ProRes codec selection
ProRes Color Profile	RWG / Log3G10 or Image / LUT settings
Pre-Record	Enable and configure a pre-record clip
Recording Mode	Select Motion or Time-Lapse mode
Timelapse	Interval Time and Frames per Interval
Frame Limit	Enable, Frames, and Playback Duration
Slate	Camera ID and Camera Position

## FORMAT

Use the Format setting to designate how much of the sensor the camera should use to capture images.

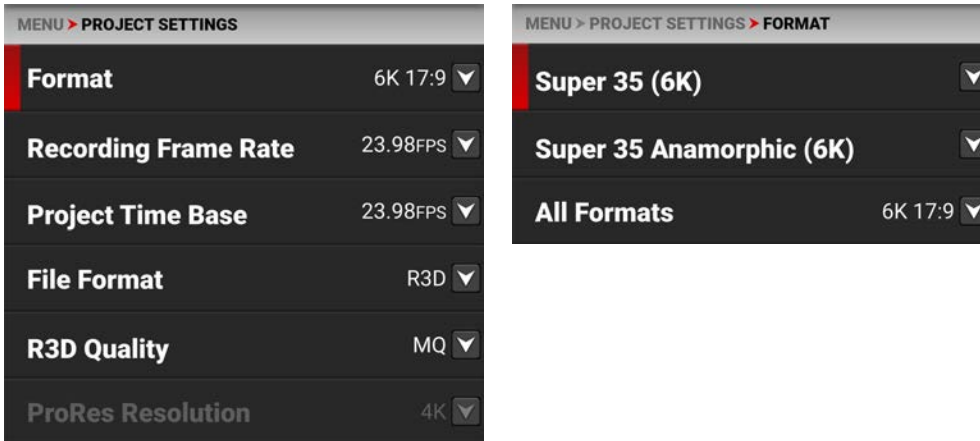

Use the Format menu to configure the camera's sensor capture area settings:

ITEMS	DETAILS
Super 35 (6K)	Select from Super 35 sensor capture areas
Super 35 Anamorphic (6K)	Select from Super 35 anamorphic sensor capture areas
All Formats	Select from all sensor capture areas

The available aspect ratios are determined by the selected resolution. The default format setting is 6K 17:9.

When you lower the resolution on the camera, only a portion of the sensor is used. The camera does not downscale from the 6K 17:9 format when recording RAW.

**NOTE:** The anamorphic formats are only available when the project file format is set to R3D (refer to [File Format](#)).



## SUPER 35 (6K)

Use the Super 35 (6K) format setting to designate how much of the sensor the camera should use to capture images.

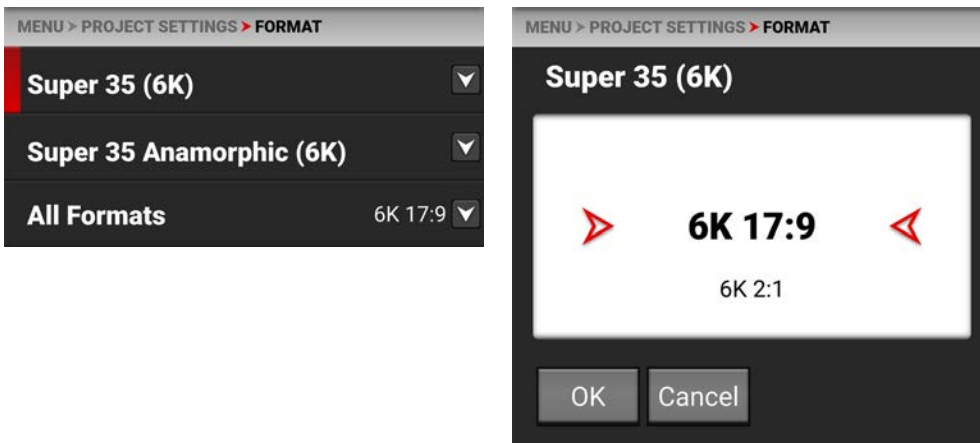

The available aspect ratios are determined by the selected resolution.

When you lower the resolution on the camera, only a portion of the sensor is used. The camera does not downscale from the 6K 17:9 format when recording RAW.

### SUPER 35 (6K) FORMAT SPECIFICATIONS

This table contains the dimensions of the sensor area in Pixels and in Millimeters used by each Super 35 (6K) format. The default format is 6K 17:9.

FORMAT	DIMENSION (PIXELS)		DIMENSIONS (MM)		
	WIDTH	HEIGHT	WIDTH	HEIGHT	DIAGONAL
6K 17:9	6144	3240	27.03	14.26	30.56
6K 2:1	6144	3072	27.03	13.52	30.22
6K 2.4:1	6144	2574	27.03	11.32	29.30
6K 16:9	5760	3240	25.34	14.26	29.08

## SUPER 35 ANAMORPHIC (6K)

Use the Super 35 Anamorphic Format setting to designate how much of the sensor the camera should use to capture images.

**NOTE:** The anamorphic formats are only available when the project file format is set to R3D (refer to [File Format](#)).

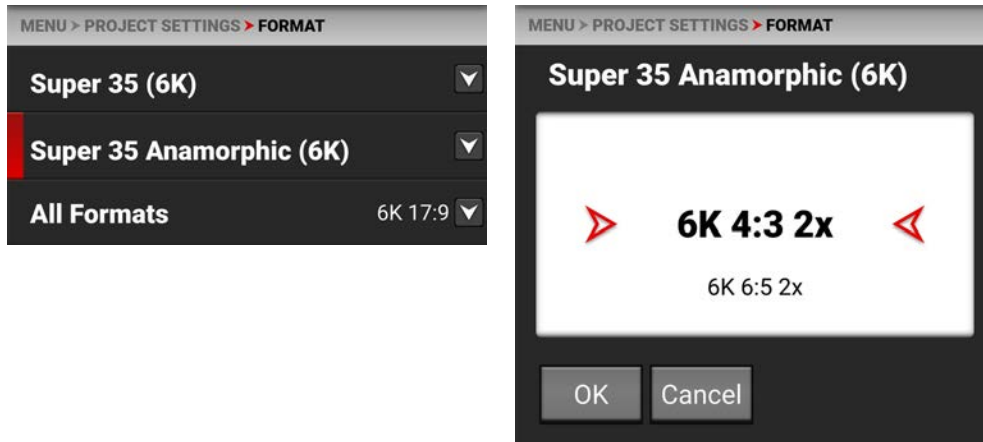

The available aspect ratios are determined by the selected resolution.

When you lower the resolution on the camera, only a portion of the sensor is used. The camera does not downscale from the 6K 17:9 format when recording RAW.

## SUPER 35 ANAMORPHIC (6K) FORMAT SPECIFICATIONS

This table contains the effective dimensions of the sensor area in Pixels and in Millimeters used by each Super 35 Anamorphic (6K) format.

The default setting is 6K 4:3 2x.

FORMAT	DIMENSION (PIXELS)		DIMENSION DE-SQUEEZED (PIXELS)		DIMENSIONS (MM)		
	WIDTH	HEIGHT	WIDTH	HEIGHT	WIDTH	HEIGHT	DIAGONAL
6K 4:3 2x	4320	3240	8640	3240	18.61	14.26	23.45
6K 6:5 2x	3888	3240	7776	3240	17.11	14.26	22.27
6K 3:2 1.8x	4860	3240	8748	3240	21.38	14.26	25.70
6K 4:3 1.8x	4320	3240	7776	3240	19.01	14.26	23.76
6K 3:2 1.6x	4860	3240	7776	3240	21.38	14.26	25.70
6K 16:9 1.5x	5760	3240	8640	3240	25.34	14.26	29.08
6K 17:9 1.3x	6144	3240	8192	3240	27.03	14.26	30.56
6K 17:9 1.25x	6144	3240	7680	3240	27.03	14.26	30.56

## ALL FORMATS

Use the All Formats setting to select from all of the possible formats to designate how much of the sensor the camera should use to capture images.

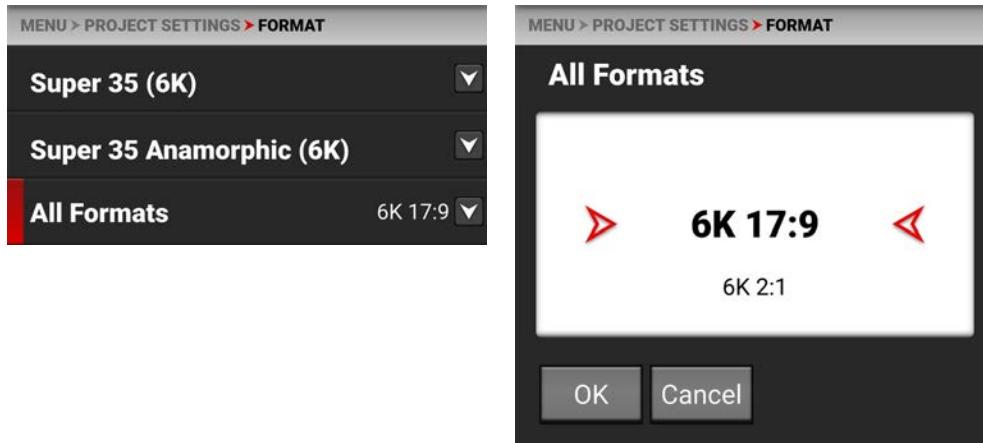

The available aspect ratios are determined by the selected resolution.

When you lower the resolution on the camera, only a portion of the sensor is used. The camera does not downscale from the 6K 17:9 format when recording RAW.

## FORMAT SPECIFICATIONS

This table contains the dimensions of the sensor area in Pixels and in Millimeters used by all of the camera formats. The default setting is 6K 17:9.

FORMAT	DIMENSION (PIXELS)		DIMENSIONS (MM)		
	WIDTH	HEIGHT	WIDTH	HEIGHT	DIAGONAL
6K 17:9	6144	3240	27.03	14.26	30.56
6K 2:1	6144	3072	27.03	13.52	30.22
6K 2.4:1	6144	2574	27.03	11.32	29.30
6K 16:9	5760	3240	25.34	14.26	29.08
6K 4:3 2x	4320	3240	18.61	14.26	23.45
6K 6:5 2x	3888	3240	17.11	14.26	22.27
6K 3:2 1.8x	4860	3240	21.38	14.26	25.70
6K 4:3 1.8x	4320	3240	19.01	14.26	23.76
6K 3:2 1.6x	4860	3240	21.38	14.26	25.70
6K 16:9 1.5x	5760	3240	25.34	14.26	29.08
6K 17:9 1.3x	6144	3240	27.03	14.26	30.56
6K 17:9 1.25x	6144	3240	27.03	14.26	30.56
5K 17:9	5120	2700	22.53	11.88	25.47
4K 17:9	4096	2160	18.02	9.50	20.37
4K 16:9	3840	2160	16.90	9.50	19.39
2K 17:9	2048	1080	9.01	4.75	10.19

## RECORDING FRAME RATE

Use Recording Frame Rate to select the recording frame rate (also referred to as the capture frame rate).

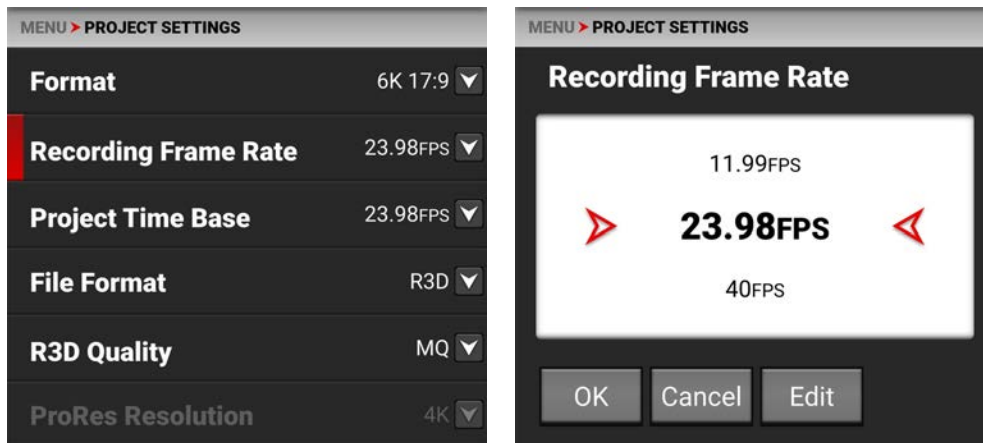

The recording frame rate is the number of frames per second (FPS) that are recorded. The recording frame rate is different from the project time base, which is the rate at which the footage will be played back. Lower values than the project time base will result in under-cranking (fast motion playback) and values larger than the project time base will result in over-cranking (slow motion playback).

The minimum and maximum frame rate for each format is determined by **Project Time Base** and **Format**.

When you select a Project Time Base it will automatically set the Recording Frame Rate to match (when possible). You must select the Recording Frame Rate after the Project Time Base to select a different Recording Frame Rate.

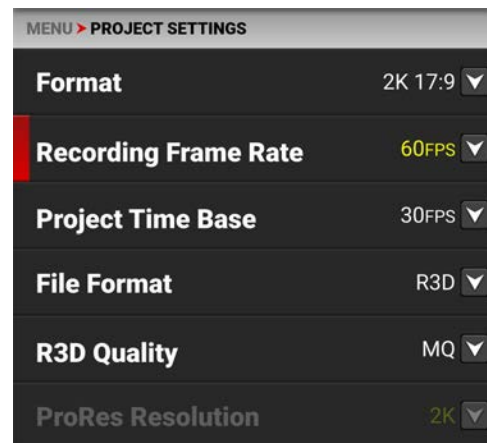

A Recording Frame Rate highlighted in **yellow** will result in playback occurring at a different frame rate than the original recording, and will record varispeed audio.

## PROJECT TIME BASE

Use the Project Time Base setting to choose the playback rate for the recorded footage.

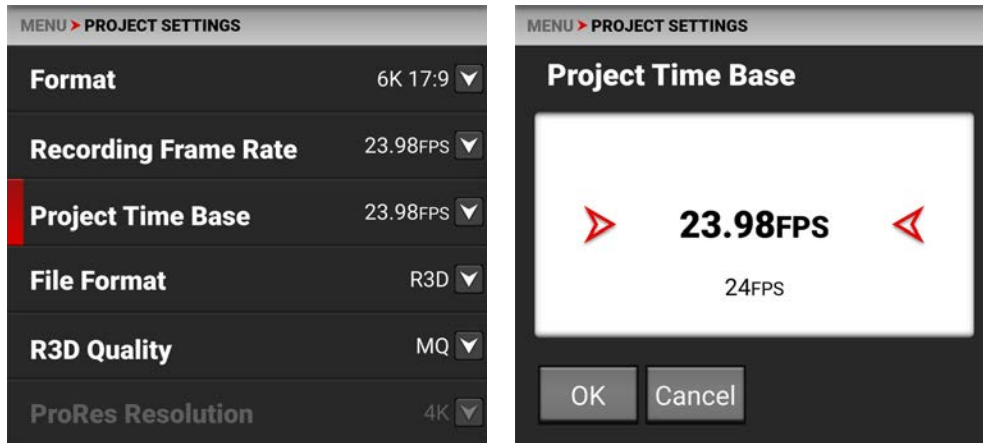

The following project time bases are available:

- 23.98 FPS (Default)
- 24.00 FPS
- 25.00 FPS
- 29.97 FPS
- 30.00 FPS
- 50.00 FPS
- 59.94 FPS
- 60.00 FPS

When you select the Project Time Base, it changes the Recording Frame Rate to the same setting (when possible).

When you change the Format, the Recording Frame Rate and Project Time Base do not automatically update. You must select the Project Time Base after you change the Format setting.

**NOTE:** When the Recording Frame Rate is set to a higher speed than the Project Time Base setting, audio is recorded as varispeed audio.

## FILE FORMAT

Use File Format to select the format that the camera uses to record image files.

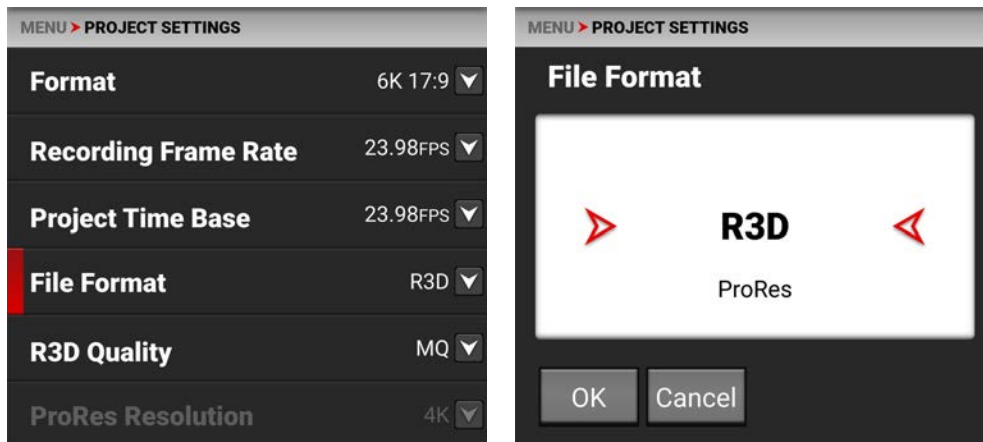

When you change the file format, a message warns you that the camera must be rebooted to complete the change:



### R3D REDCODE FILE FORMAT

The RED R3D file format records images in a compressed RAW format. In comparison to Apple ProRes, REDCODE RAW data does not bake in image settings like ISO, saturation, or LUTs, allowing more flexibility in post-processing workflows without reducing image quality or dynamic range. Instead R3D files store the image settings as Metadata. You can open and process R3D files with REDCINE-X PRO or with non-linear editing (NLE) software that supports the RED SDK.

R3D is the camera's default file format.

### APPLE PRORES FORMAT

This section provides general information about recording Apple ProRes files with the camera, including:

- Recording Apple ProRes is only available:
  - When recording to Apple ProRes only
  - When recording to the Apple ProRes 422 HQ or ProRes 422 codec
- QuickTime files have the same metadata that is in the REDCODE RAW files. The metadata is per clip, and not per frame. At this time, there is no tool for extracting that metadata from the QuickTime files.
- You can select a **Format** from the **Project Settings Menu** and the camera will scale it to the target resolution you select in **ProRes Resolution**.
- Recording 4K ProRes files are limited to 4K and above Formats. When in ProRes, Formats below 4K will automatically be recorded as 2K.
- For more information about Apple ProRes, including the data rates for each codec, refer to the **Apple ProRes White Paper**.

## APPLE PRORES DESCRIPTION

The table below describes each supported Apple ProRes codec.

NAME	CHROMA SAMPLING	DATA RATE
ProRes 422 HQ	Y' C <sub>b</sub> C <sub>r</sub> 4:2:2	754 Mbps at 4K (4096 x 2160) and 24 FPS
ProRes 422	Y' C <sub>b</sub> C <sub>r</sub> 4:2:2	503 Mbps at 4K (4096 x 2160) and 24 FPS

## FILE STRUCTURE OF RECORDED APPLE PRORES FILES

When you record using ProRes format, this is the file structure of the recorded files on the media:

- .RDM Folder
  - .RDC Folder
    - .mov

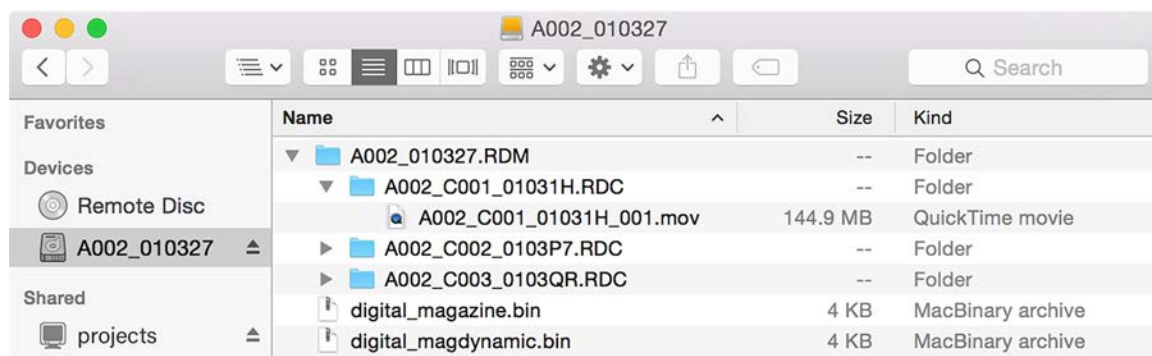



## R3D QUALITY

Use R3D Quality to select the R3D data rate the camera uses to record the image files.

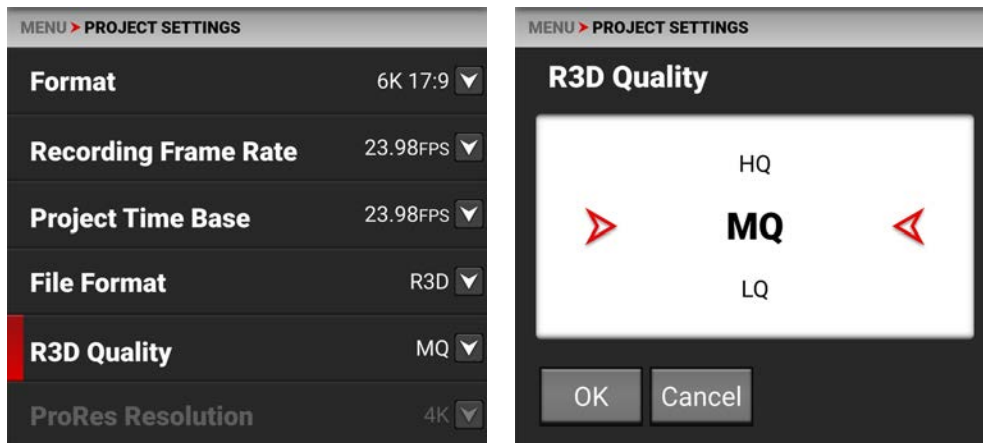

The R3D Quality selections include:

- HQ - High data rate - Up to ~ 280 MB/s (~30 minutes recording time)\*
- MQ - Medium data rate (default) - ~175 MB/s (~48 minutes recording time)\*
- LQ - Lowest data rate - ~110 MB/s (~1 hour and 17 minutes recording time)\*

\* Data rate assumes camera settings at 6K 17:9, 23.98 FPS. Recording time assumes a 512 GB CFast card. Your actual data rate will depend on complexity of the shooting scene and capture settings. Data rates subject to change with future updates.

For high complexity scenes, VFX, and stills from motion workflows, RED recommends the HQ setting. For cinema (non-VFX) and high-end TV, RED recommends the MQ setting. For TV, online content, documentary and interviews, RED recommends the LQ setting.

## PRORES RESOLUTION

When you enable ProRes as the **File Format** you can select the ProRes resolution.

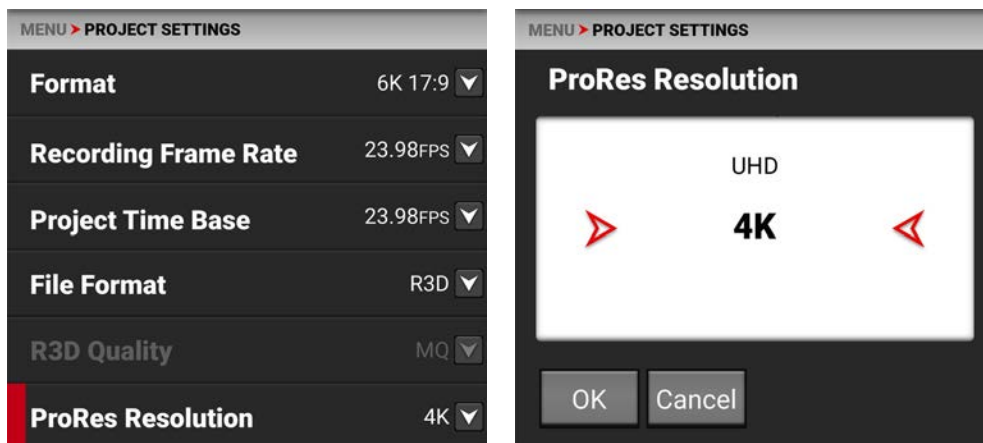

The ProRes Resolution selections include:

- HD
- 2K
- UHD
- 4K (default)

The camera will downscale to achieve the selected ProRes resolution when the aspect ratios of your format and ProRes resolution do not match. It is recommended to shoot 4K or 2K ProRes when the format is 17:9, and to shoot UHD or HD when the format is 16:9.

## PRORES CODEC

When you enable ProRes as the **File Format** you can select the ProRes Codec.

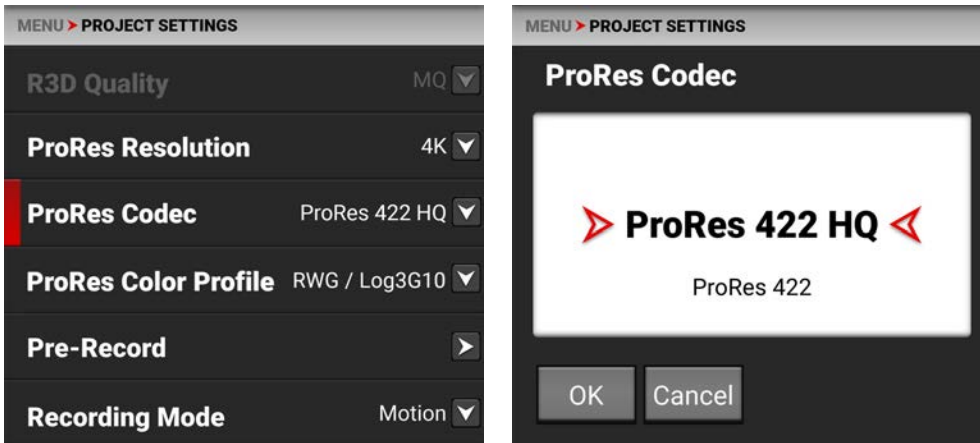

The ProRes Codec selections include:

- ProRes 422 HQ
- ProRes 422

## PRORES COLOR PROFILE

When you enable ProRes as the **File Format** you can select the color profile.

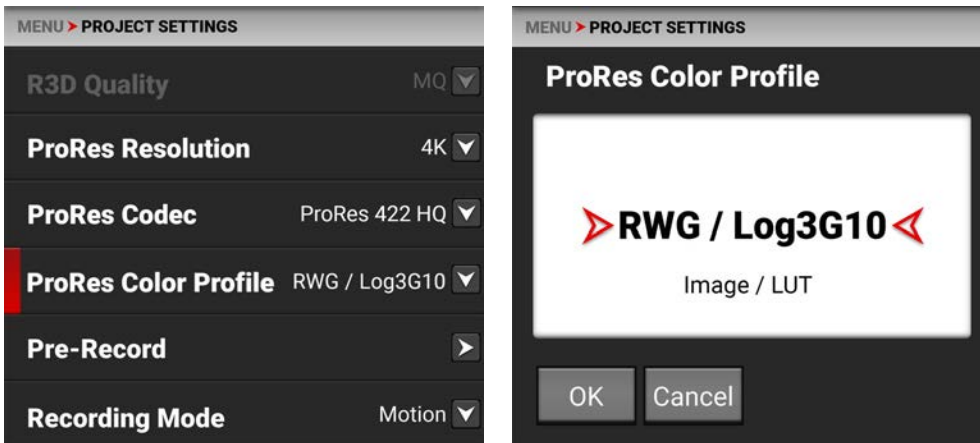

The ProRes Color Profile settings include:

- RWG/Log3G10 - REDWideGamutRGB color space and Log3G10 gamma curve
- Image / LUT - Applies all Image / LUT settings for **Output Color Space**, **Display Preset**, **3D LUT**, and **CDL**

**NOTE:** All ProRes Color Profile settings bake in both the ISO and the White Balance settings.

## PRE-RECORD

Use the Pre-Record menu to enable or disable Pre-Record, and to adjust the length of the Pre-Recorded clip.

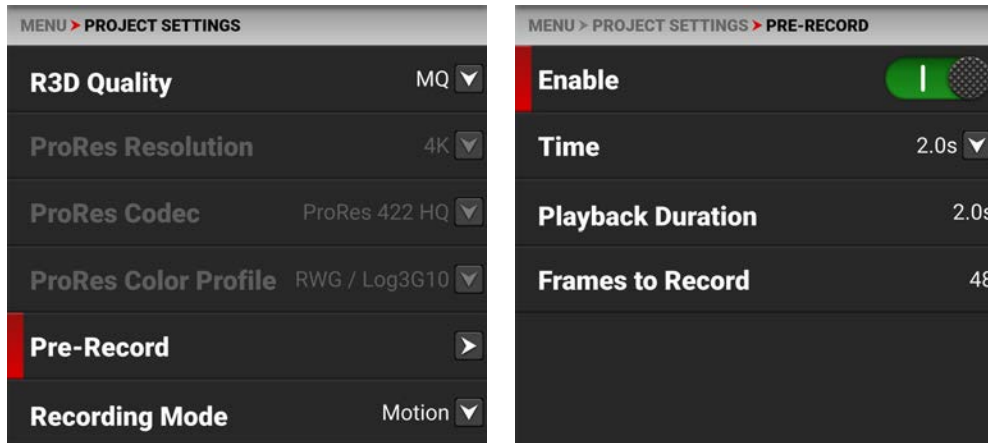

Pre-Record allows you to continually capture images to a small amount of memory while waiting to begin recording. This allows you to capture unexpected events such as, a whale breaching the water, or an athlete scoring a goal. When you finish recording, the pre-recorded clip is added to the beginning of the recording.

You can set the Pre-Record clip to record from half a second up to 30 seconds, depending on the format, file type, resolution, and quality. The default setting is 2 seconds at the default Project Time Base of 23.98 FPS.

For more information, refer to [Pre-Recording Content](#).

### ENABLE

Select Enable to toggle Pre-Record on and off.



### TIME

Select Time to choose or enter the number of seconds to pre-record.

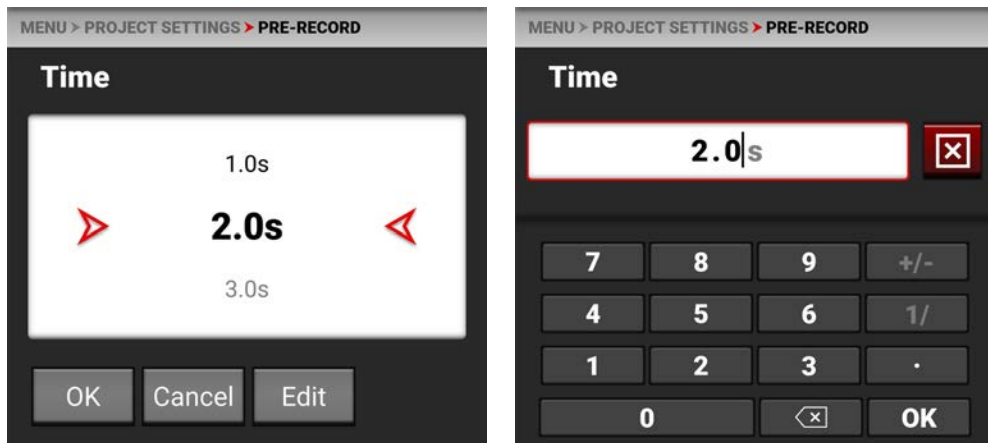

## PLAYBACK DURATION

Playback Duration displays the duration in seconds that the pre-record clip will last in playback.

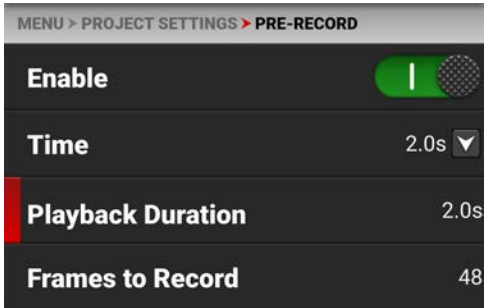

## FRAMES TO RECORD

Frames to Record displays the number of frames the pre-recorded clip will contain at the current settings.

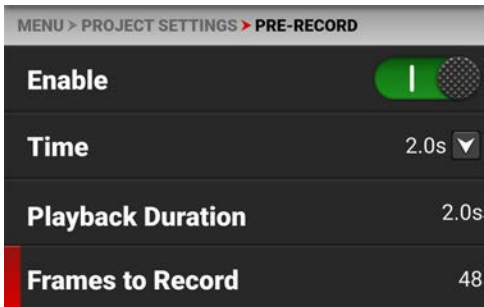

## RECORDING MODE

Use Recording Mode to select between normal motion recording or time-lapse recording.

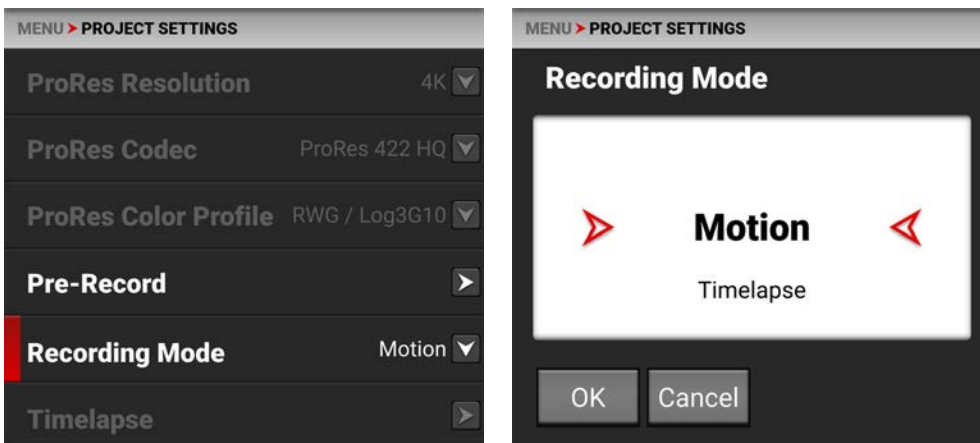

When you select Timelapse, the Timelapse option is enabled on the menu.

## TIMELAPSE

Use Timelapse to select the select the time-lapse settings.

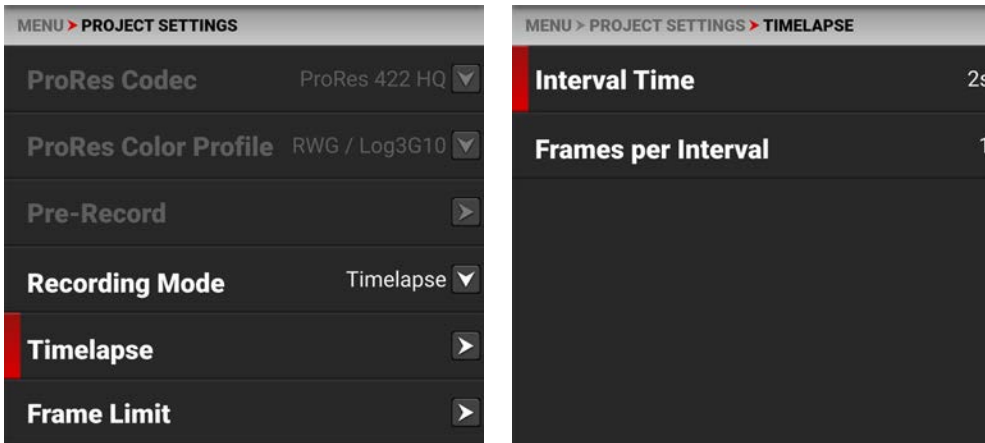

From Timelapse you can select the interval time between the group of frames per interval, and you can select the number of frames captured per interval.

## INTERVAL TIME

Select Interval Time to enter the elapsed time between the group of frames per interval.

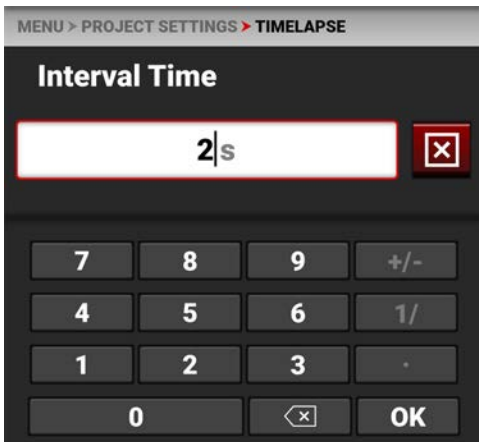

For example:

60s = 1 minute

3600s = 1 hour

86400s = 1 day

## FRAMES PER INTERVAL

Select Frames Per Interval to enter the number of frames to record per interval.

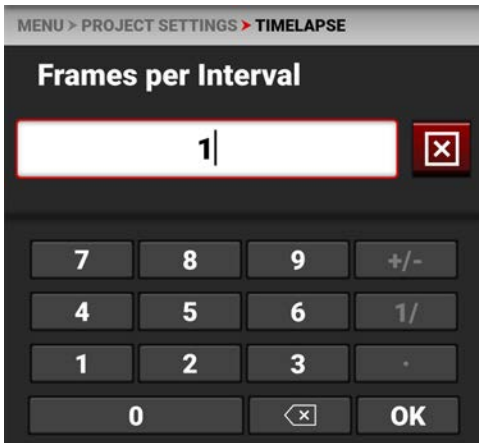

Adding more frames per interval allows you to have more flexibility in post (for example: image stacking).

## FRAME LIMIT

Use Frame Limit to limit the total number of frames recorded per clip. Frame limit applies to both Motion and Timelapse recording modes.

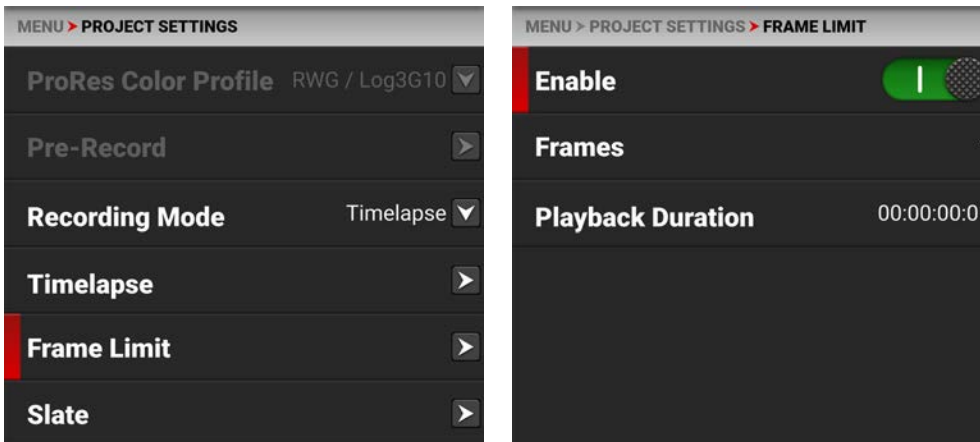

The Frame Limit selections include Enable, Frames, and Playback Duration.

## ENABLE

Select Enable to toggle the activation of the Frame Limit feature.



## FRAMES

Use frames to enter the maximum number of frames the clip can record.

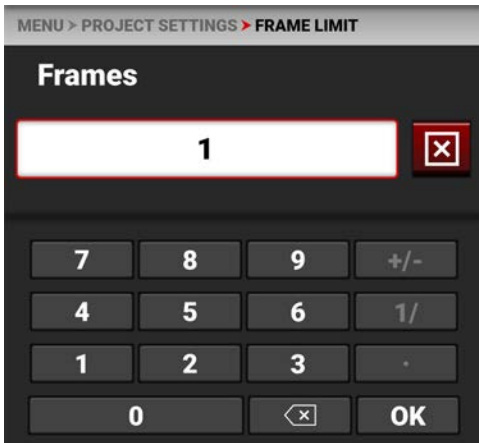

## PLAYBACK DURATION

Playback Duration displays the calculated playback duration of the clip with the selected Frame Limit and FPS. For example, using 1440 Frames as a Frame Limit at 24 FPS results in one minute of playback duration.

## SLATE

Use the Slate menu to assign a camera ID and camera position to the clip.

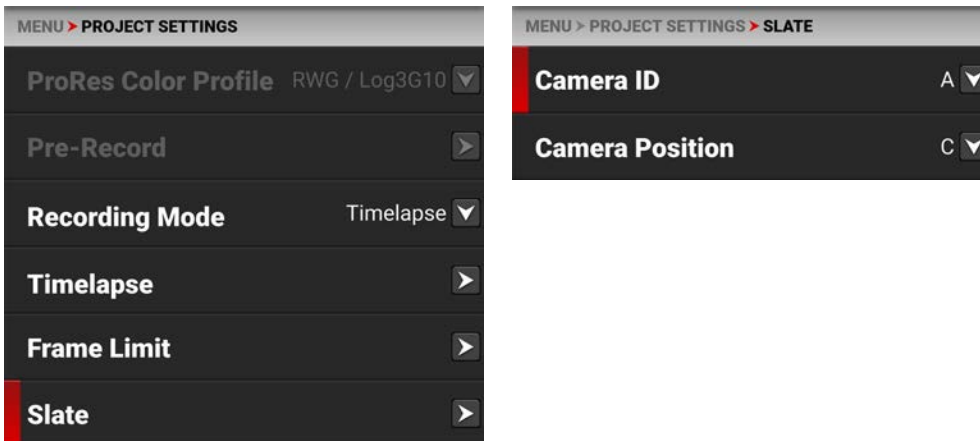

The settings you can assign to a clip include:

- Camera ID (also populates in the Media menu when formatting media)
- Camera Position (also populates in the Media menu when formatting media)



## CAMERA ID

Use Camera ID to assign a camera ID to the clip.

**NOTE:** You can also change the Camera ID by using Secure Format (refer to [Secure Format](#))

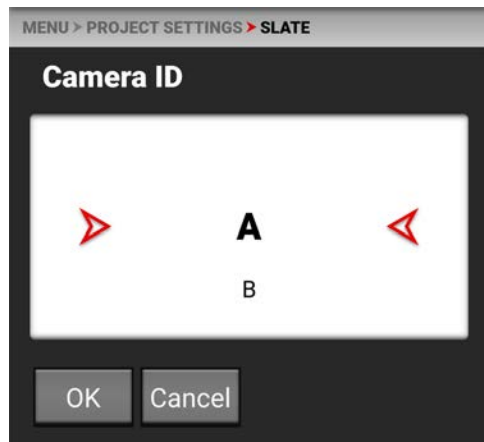

The camera IDs you can assign to a clip include the letters A-Z.

## CAMERA POSITION

Use Camera Position to assign a camera position description to the clip.

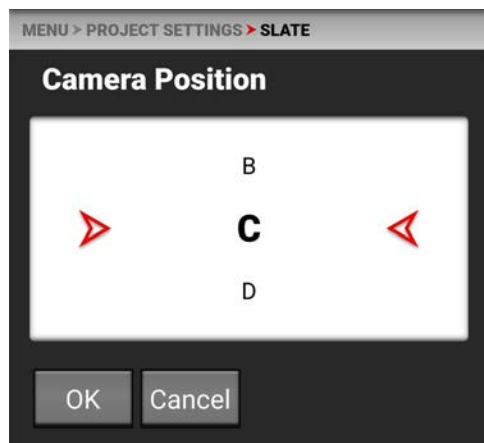

The camera positions you can assign to a clip include the letters A-Z.

**NOTE:** When you select camera positions other than L, and R, the camera position in the SDI output signal HANC data is set to "C." For more information refer to [RED.com/developers](https://www.red.com/developers).

## AUDIO / TC MENU

The Audio / TC menu contains the settings you use to configure your camera audio and Timecode.

From the camera LCD touchscreen menu, select Audio / TC:

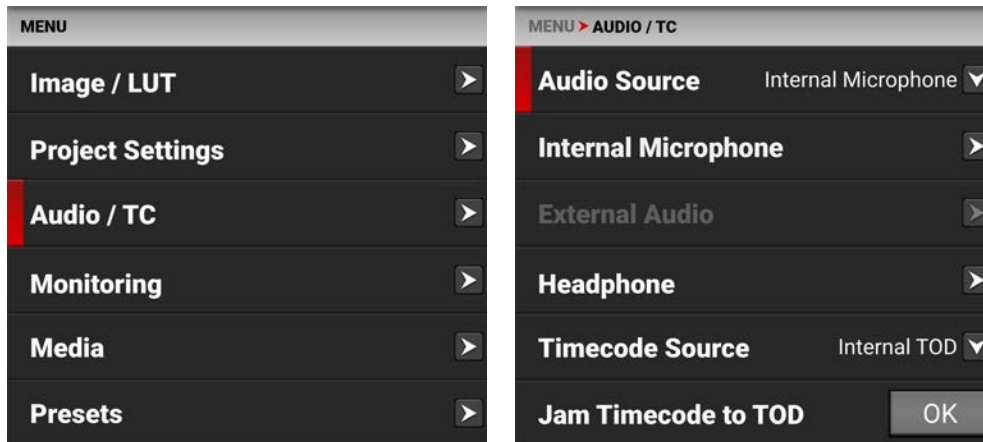

Use the Audio / TC menu to configure the audio and Timecode settings for the camera:

ITEMS	DETAILS
Audio Source	Audio input source
Internal Microphone	Left and right internal microphone levels
External Audio	Left and right external microphone levels
Headphone	Headphone volume levels
Timecode Source	Timecode source
Jam Timecode to TOD	Button to Jam Timecode to Time of Day (TOD)
Timecode Display Mode	Timecode to display

## AUDIO DETAILS

The camera is equipped with two integrated microphones suitable for scratch-track audio, and it is equipped with one 3.5 mm stereo microphone input.

You can link the gain for the two channels together. This allows you to adjust the two internal (or external) channels together as one.

You can record audio from the internal microphones, from the external audio connector (2-channel recording), or from internal and external sources combined as 24-bit 48 kHz uncompressed audio tracks.

For external audio, you can only use a microphone level signal (not line level) and adjust it by using the appropriate camera gain-settings (-52.5 dB to 36.0 dB). The default camera gain setting is 0 dB.

The camera's audio data is synchronized with video and timecode, and it is embedded in the R3D file. You can export the audio data as separate audio files by using REDCINE-X PRO, if needed. The camera also embeds the audio in the SDI output.

You can monitor the audio during recording and playback by using the equipped 3.5 mm stereo headphone port.

## VARISPEED AUDIO

Firmware versions 1.5 and higher support recording audio when the camera's Recording Frame Rate is set to a higher speed than the Project Time Base setting (Varispeed mode).

**NOTE:** The camera records the audio as a separate WAV file and stores it in the clip's RDC folder on the media drive.

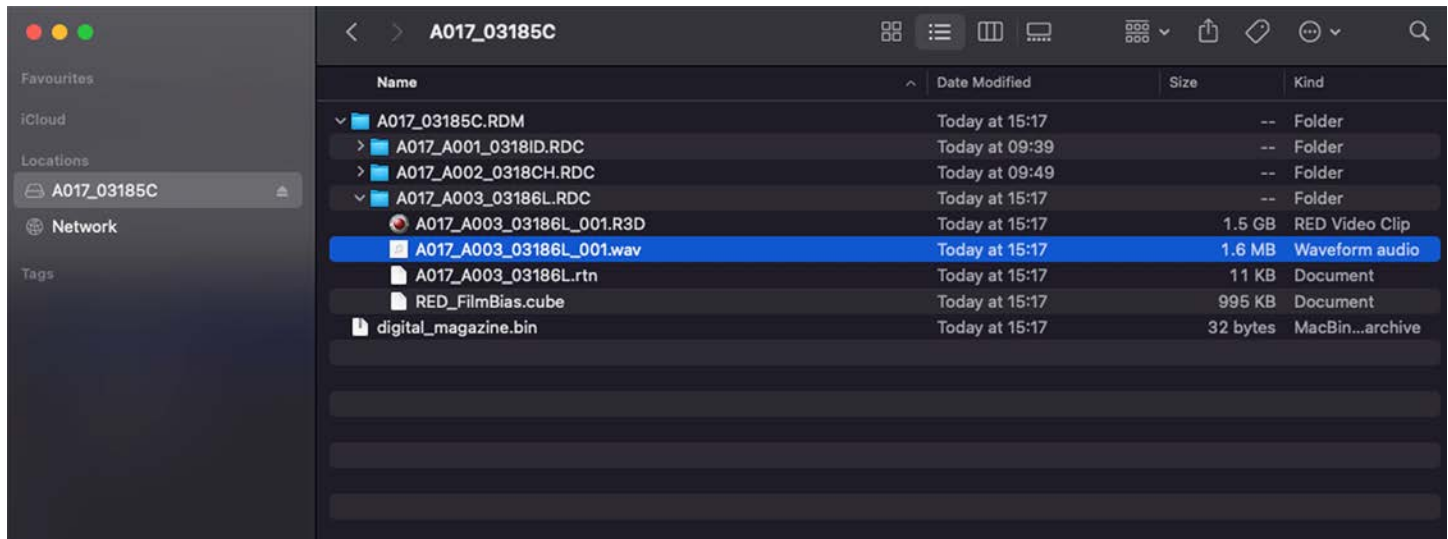

## TIMECODE DETAILS

Timecode provides a mechanism to reference frames from the camera's recorded clips to external devices such as, other cameras or audio recorders. Some devices can also gather additional data such as, lens metadata, or camera orientation, which Timecode can later use for merging the data back together in post-processing.

The camera provides two separate Timecode formats:

- **Time Of Day (TOD)** - The camera records the time of day as the Timecode for each clip
- **Edgecode** - The camera records elapsed time as the Timecode for each clip. The time is reset to 01:00:00 when a new media card is inserted in the camera. All of the clips on the media will have a continuous Timecode track. However, each new media card will default to a Timecode track starting at 01:00:00. You can change the Edgecode to begin at any desired time by using the Media Format menu (refer to [Edgecode](#)).

The camera synchronizes (jams) the TOD Timecode to an external Timecode generator (when one is connected to the [Extension Port](#)) or it jams the Timecode to its internal real-time clock.

The camera stores TOD and Edge Timecode in the R3D file. You can select which one you want to display on the [LCD Touchscreen](#).

## AUDIO SOURCE

Use the Audio Source settings to select the audio input source.

**NOTE:** When the Recording Frame Rate and Project Time Code settings are different, this menu is disabled, and the camera cannot record audio.

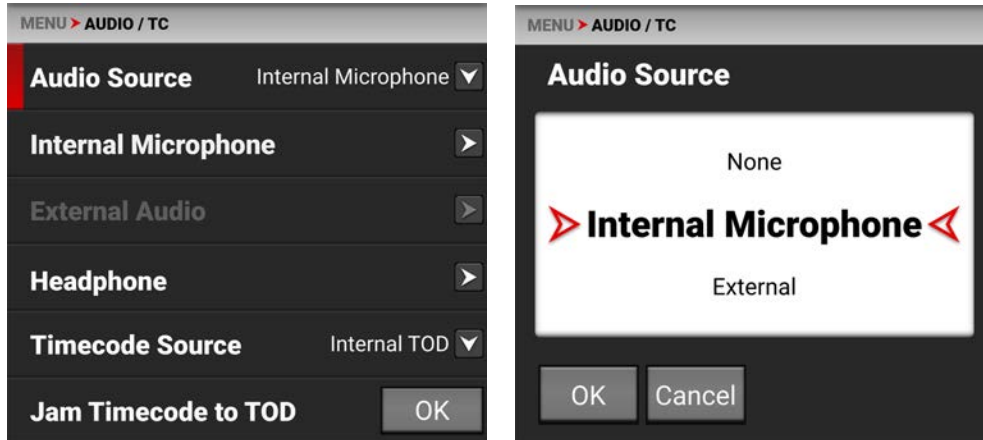

The audio input sources include:

- None
- Internal Microphone - enables the **Internal Microphone** channels 1 and 2 (default)
- External - enables the 3.5 mm Audio Input port for **External Audio** channels 3 and 4
- Internal and External - enables the Internal Microphone and 3.5 mm Audio input port for all channels 1 through 4.  
NOTE: The headphones can only monitor two channels. You can either monitor channels 1 and 2 (internal microphone) or you can monitor channels 3 and 4 (external port). Refer to **Audio Tools** for more information.

## INTERNAL MICROPHONE

Use the Internal Microphone settings to set the left and right internal microphone levels. This menu is only enabled when the **Audio Source** is set to Internal Microphone or Internal and External.

**NOTE:** When the Recording Frame Rate is set to a higher speed than the Project Time Base setting, audio is recorded as varisped audio.

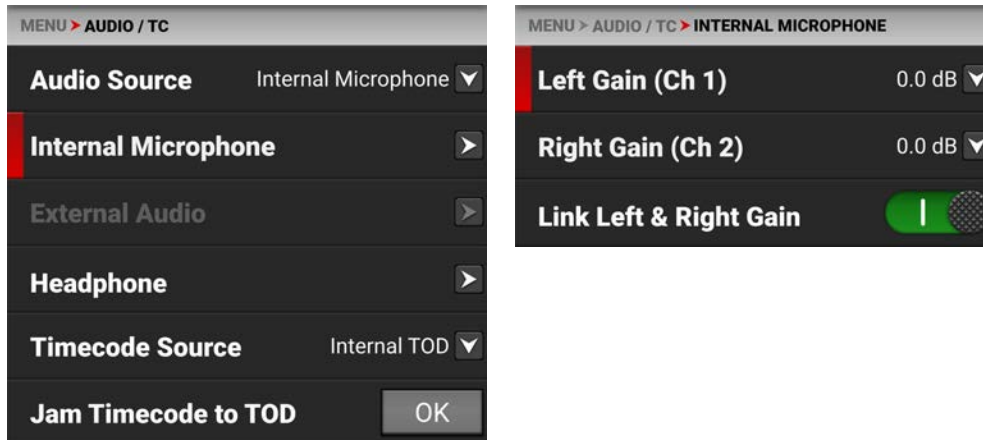

The Internal Microphone is represented as Channels 1 and 2 on the UI VU Meters (refer to **Playback** for more information). The left channel is channel 1 (Ch 1) and the right channel is channel 2 (Ch 2).

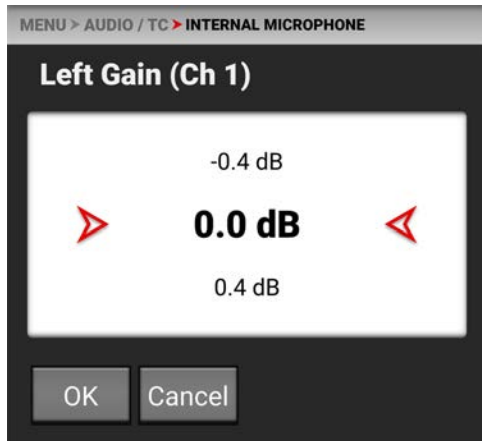

You can adjust the internal audio levels for left and right from -52.5 dB to 36.0 dB.

The default setting is 0 dB.

When you enable Link Left & Right Gain, the adjustments you make to either channel of gain will adjust both channels to the same setting.

## EXTERNAL AUDIO

Use the External Audio settings to set the left and right external audio levels. This menu is only enabled when the **Audio Source** is set to External or set to Internal and External.

**NOTE:** When the Recording Frame Rate is set to a higher speed than the Project Time Base setting, audio is recorded as varisped audio.

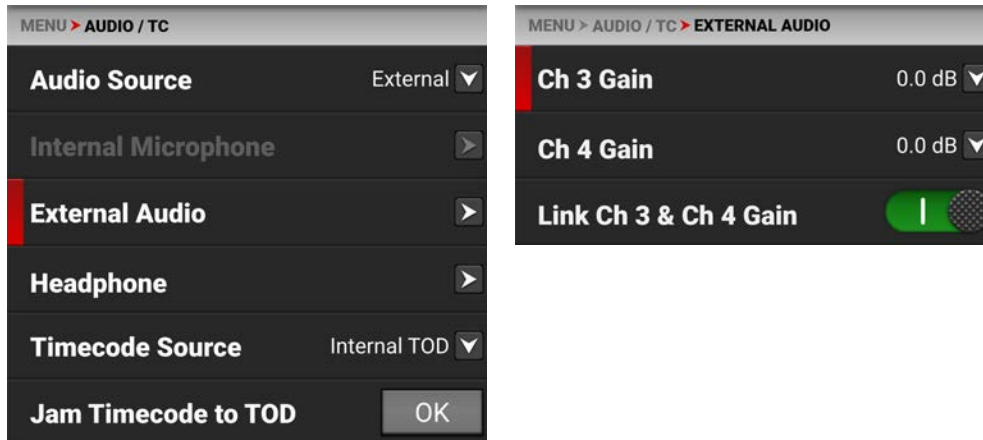

The External Microphone is represented as Channels 3 and 4 on the UI VU Meters (refer to **Playback** for more information).

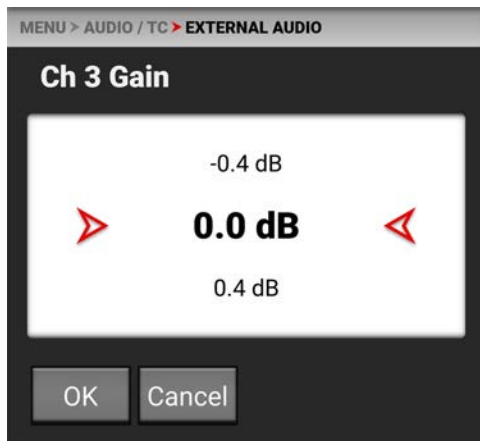

You can adjust the external audio levels for Ch 3 and Ch 4 from -52.5 dB to 36.0 dB.

The default setting is 0 dB.

When you enable Link Ch 3 & Ch 4 Gain, the adjustments you make to either channel of gain will adjust both channels to the same setting.

## HEADPHONE

Use the Headphone settings to enable the headphone jack and to adjust the headphone volume.

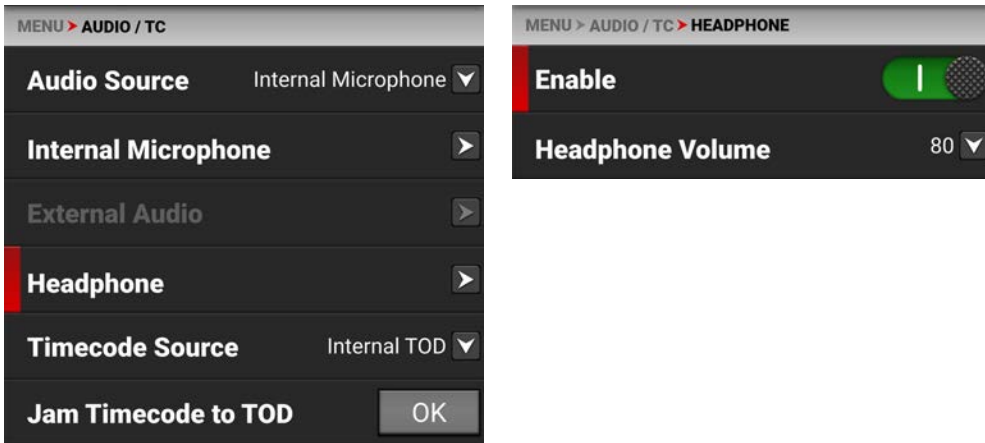

You can enable and disable the headphone audio jack by tapping the Enable toggle to the right (green) and to the left (red).



You can adjust the headphone volume from 0 to 100.

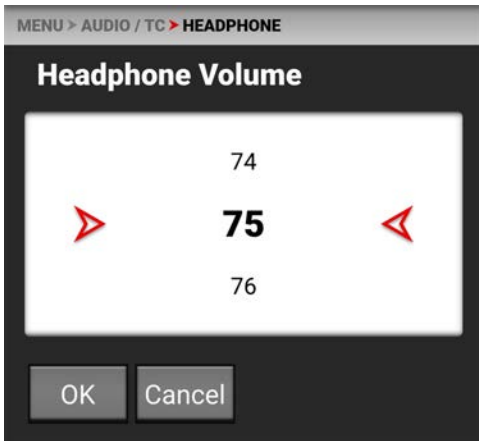



## TIMECODE SOURCE

Use Timecode source to configure the Timecode source the camera applies to the recordings.

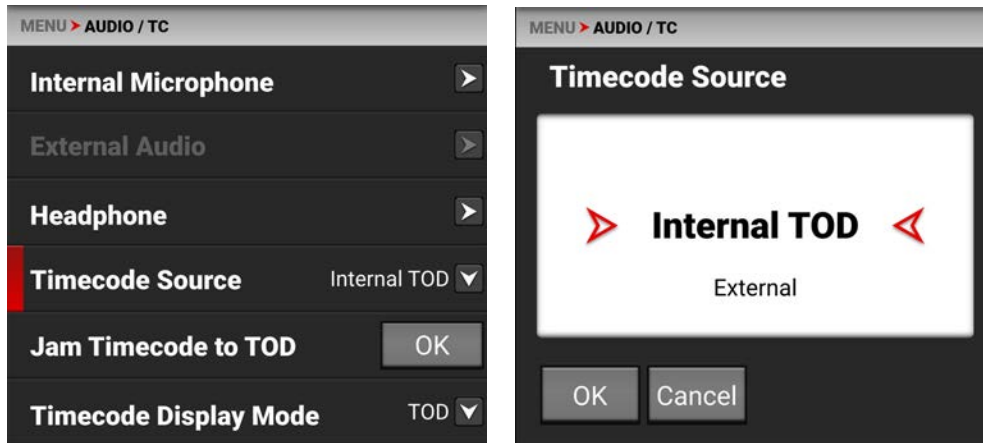

You can set the Timecode source as Internal Time of Day (TOD) or External.

When you set the camera Timecode source to External, you can connect an external Timecode generator to the [Extension Port](#).

## TIMECODE DISPLAY MODE

Use Timecode Display Mode to configure the Timecode display type that the camera applies to the recordings.

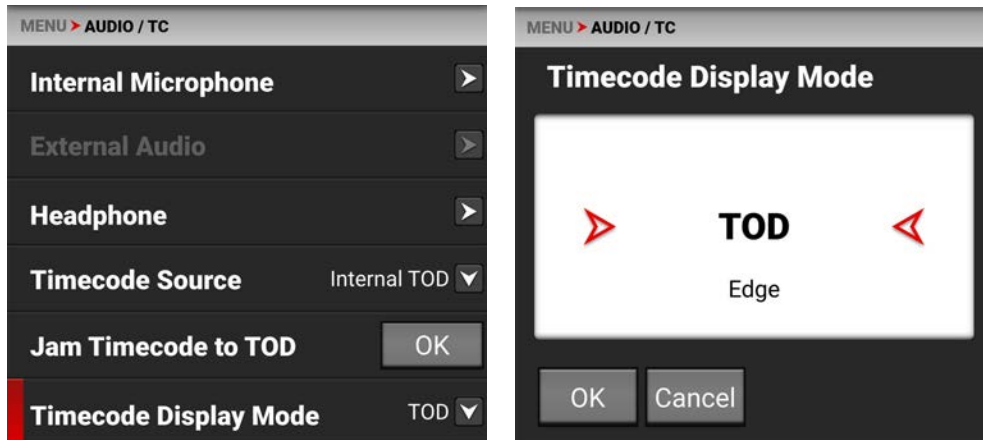

You can set the Timecode Display Mode as Time of Day (TOD) or Edge.

### TOD DISPLAY MODE

Time of Day (TOD) display mode displays the Timecode as the time of day that the frame was recorded.

### EDGE DISPLAY MODE

Edge display mode displays the Timecode as the sequential recording time that has elapsed starting with the first frame.

## MONITORING MENU

The Monitoring menu contains the settings you use to configure your camera monitoring options.

From the **LCD Touchscreen** menu, select Monitoring:

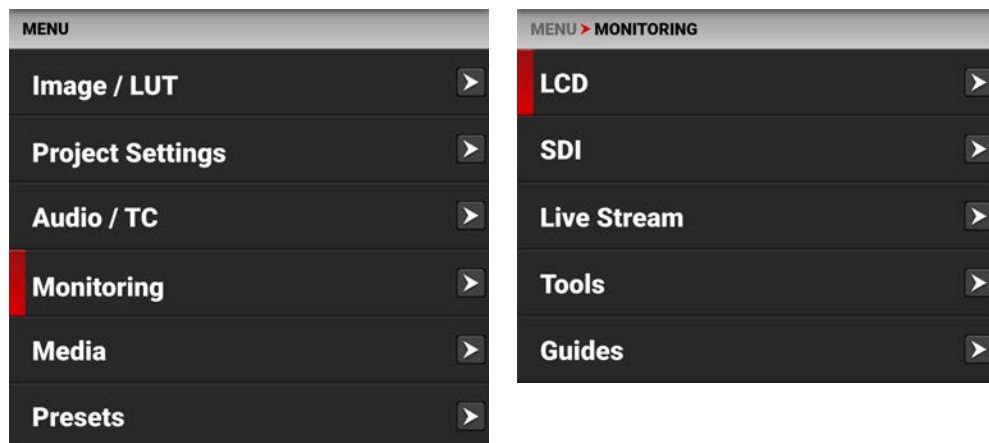

Use the Monitoring menu to configure the monitoring settings:

ITEMS	DETAILS
LCD	LCD Touchscreen settings
SDI	SDI port resolution, frequency, look, guides, tools, overlay, and overlay mode
Live Stream	Enable or disable Wi-Fi live streaming
Tools	Various monitoring tools including False Color, Peaking, and Zebra Modes
Guides	Frame guides and a center guide

## LCD

Use LCD to configure the **LCD Touchscreen** settings.

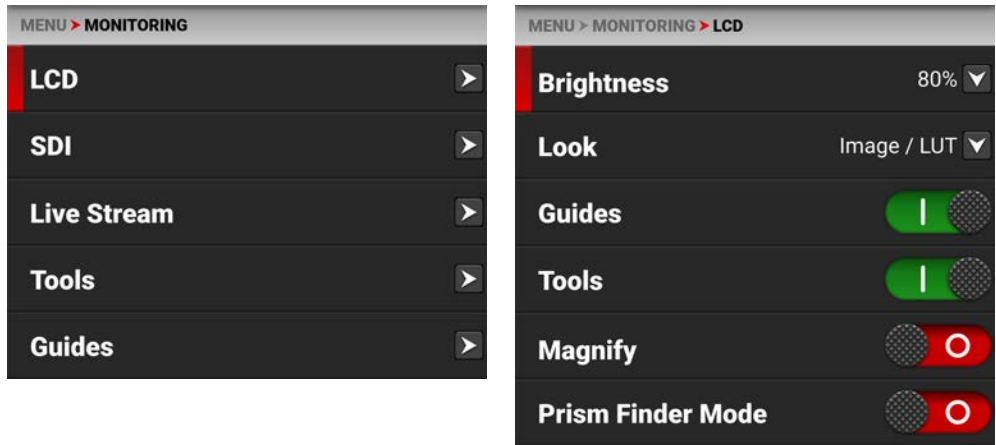

The LCD settings you can configure include:

ITEMS	DETAILS
<b>Brightness</b>	Adjust the LCD touchscreen brightness
<b>Look</b>	Select the Image / LUT, or RWG and Log3G10 image preview look
<b>Guides</b>	Enable or disable the camera guides
<b>Tools</b>	Enable or disable the camera tools
<b>Magnify</b>	Enable or disable LCD magnification
<b>Prism Finder Mode</b>	Enable or disable the prism finder mode (horizontally flip the LCD)

## BRIGHTNESS

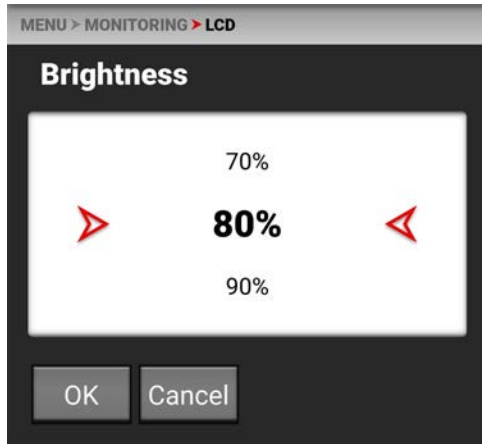

You can adjust the camera's top LCD brightness from 10% to 100%. The default is 80%

## LOOK

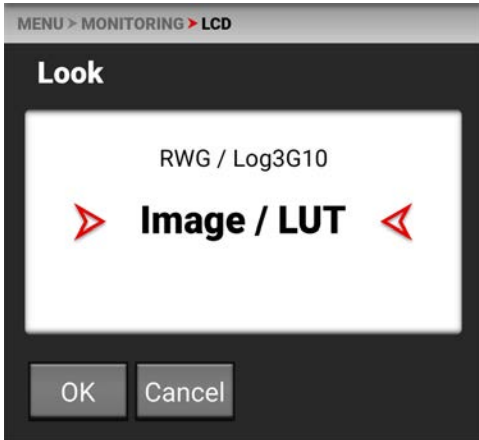

You can select the look of the image preview on the LCD. The selections include:

- REDWideGamutRGB / Log3G10
- Image / LUT (default).

## GUIDES

Use the toggle to enable (default) or disable the camera guides.



## TOOLS

Use the toggle to enable (default) or disable the camera tools.



## MAGNIFY

Use the toggle to enable or disable (default) LCD magnification.



## PRISM FINDER MODE

Use the toggle to enable or disable (default) the LCD flip view.



## SDI

Use SDI to configure the SDI port settings.

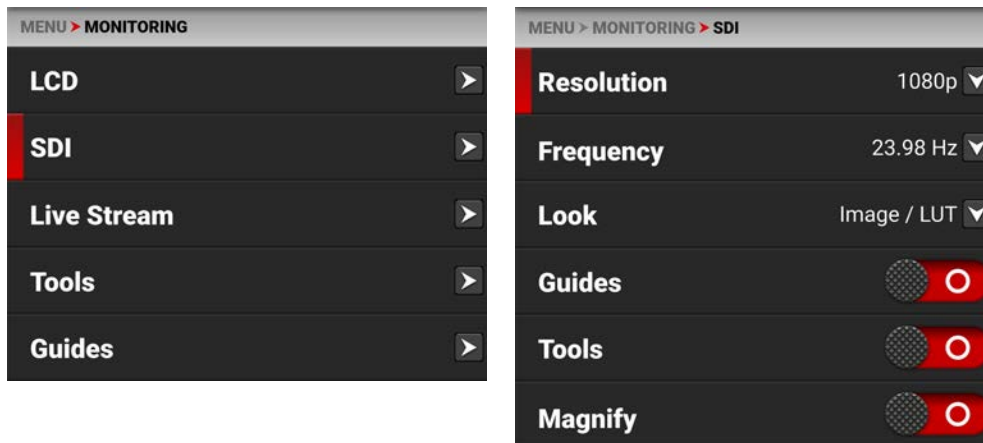

The SDI port settings you can configure include:

ITEMS	DETAILS
Resolution	Select the SDI port resolution
Frequency	Select the SDI port frequency
Look	Set the look of the playback between RWG / Log3G10 or Image / LUT
Guides	Enable or disable the monitor guides
Tools	Enable or disable the monitor tools
Magnify	Enable or disable monitor magnification
Overlay	Enable or disable the monitor overlay
Overlay Mode	Select the overlay type

**WARNING:** Under certain circumstances, it is possible for an SDI connector to incur damage when connected to an accessory and powered without using shielded cables. RED recommends only using high quality, shielded BNC cables that are rated for 12G-SDI signals and only using shielded power cables for powering SDI accessories.

Make sure power is connected to the SDI accessory at all times before you connect the BNC to the camera. Ungrounded power from SDI accessories can damage the camera's SDI port. To avoid this possible damage, attach the power source to the accessory before attaching it to the BNC cable. When using RED Approved Third Party battery plates, unplug the BNC cable prior to hot swapping.

When possible, avoid using P-Tap (also known as D-Tap) cables to power accessories. To avoid damage when using P-Tap/D-Tap, it's imperative that the connect/disconnect sequence (below) is followed precisely.

### BNC ATTACHMENT INSTRUCTIONS

When attaching SDI accessories:

1. Connect a power source to the SDI accessory; power on the SDI accessory.
2. Ensure a power source is connected to the camera. This ensures both are grounded prior to connecting the BNC. The camera's power state does not have an impact on SDI attachment sequence.
3. Connect the BNC cable to the accessory, then to the camera.

When detaching an accessory mounted to an SDI output, ensure that you remove the BNC connection to the camera before removing power to the SDI device:

1. Shutdown the SDI accessory.
2. Disconnect the BNC cable from the camera.
3. Disconnect the power source from the SDI accessory.

When you need to swap out a battery on an accessory mounted to the camera's SDI port, you must:

1. Shutdown the SDI accessory.
2. Disconnect the BNC cable from the camera.
3. Replace the battery on the SDI accessory.
4. Connect the BNC cable to the camera.
5. Power on the SDI accessory.

For more information, refer to [Preventing Damage to SDI Outputs](#).

## RESOLUTION

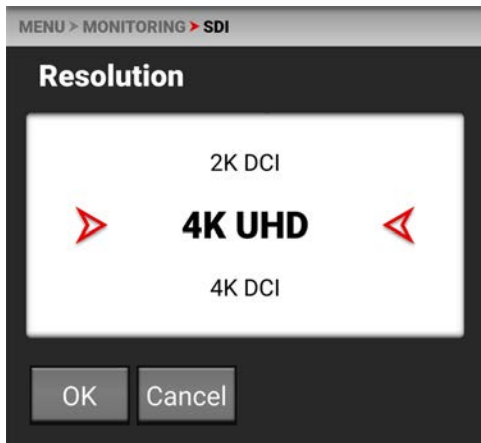

Use resolution to select one of the following SDI port resolution settings:

- 1080p (default)
- 2K DCI
- 4K UHD
- 4K DCI

The resolution selected here controls the SDI output resolution of the preview page.

## SCALING PREVIEW

When monitoring in 1080p or 4K UHD while capturing in a 17:9 format, the entire 17:9 image will be down-scaled to the 16:9 aspect ratio of 1080p or 4K UHD. Small black bars will only appear on the top and bottom of the frame in the monitor path and not on the recorded image.

## FREQUENCY

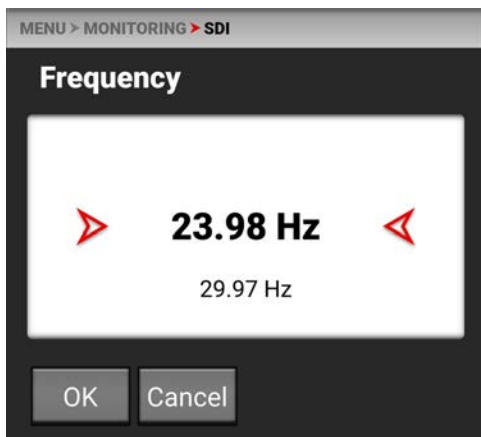

Use Frequency to select one of the following SDI port frequency settings:

- 23.98 Hz (default)
- 29.97 Hz
- 59.94 Hz

## LOOK

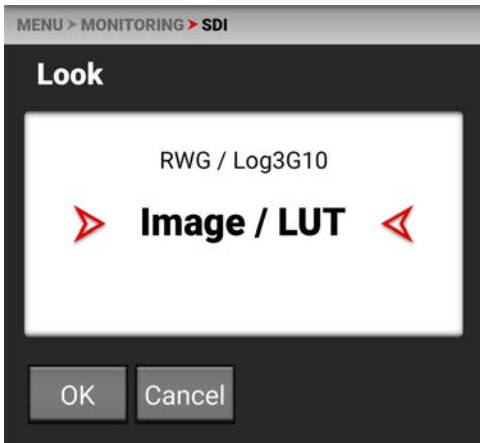

You can select the look of the image preview signal sent to the SDI port.

The selections include:

- REDWideGamutRGB / Log3G10
- Image / LUT (default)

## GUIDES

Use Guides to enable or disable (default) the viewing of guides. Tap the switch to toggle between enabled and disabled.



## TOOLS

Use Tools to enable or disable (default) the viewing of tools. Tap the switch to toggle between enabled and disabled.



## MAGNIFY

Use Magnify to enable or disable (default) monitor magnification. Tap the switch to toggle between enabled and disabled.



## OVERLAY

Use Overlay to enable (default) or disable the viewing of the overlay. Tap the switch to toggle between enabled and disabled.



## OVERLAY MODE

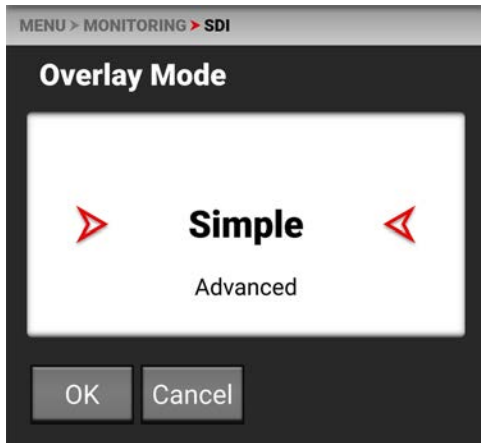

Use Overlay Mode to select one of the following SDI port overlay modes:

- Simple - minimal image information is displayed (default)
- Advanced - many image and camera details are displayed

## SIMPLE MODE



Simple mode displays the clip name and the elapsed time. When the camera is recording, the elapsed time turns red, and a red dot appears in the top right corner.





## ADVANCED MODE



Advanced mode displays the following:

### TOP

- Camera Number
- Recording Frame Rate
- f-Stop
- Focus Length
- Shutter Angle
- ISO
- White Balance

### BOTTOM

- Clip Name
- Exposure Meter
- Histogram
- CFast Time Remaining
- Temp / Exp Calibration
- Timecode, Genlock, Sync
- DC-In, Battery
- Format, File Type, Rate
- VU Meter
- Elapsed time

When the camera is recording, the elapsed time turns red, and a red dot appears in the top right corner.



## SDI PORT DESCRIPTION

The Serial Digital Interface (SDI) port allows the camera to deliver 12 Gbps of image bandwidth with greater resolution, frame rates, and color fidelity. This single BNC cable solution makes it ideal for the 4Kp60 format. The output signal bit depth is 10-bit 4:2:2.

**WARNING:** Under certain circumstances, it is possible for an SDI connector to incur damage when connected to an accessory and powered without using shielded cables. RED recommends only using high quality, shielded BNC cables that are rated for 12G-SDI signals and only using shielded power cables for powering SDI accessories.

Make sure power is connected to the SDI accessory at all times before you connect the BNC to the camera. Ungrounded power from SDI accessories can damage the camera's SDI port. To avoid this possible damage, attach the power source to the accessory before attaching it to the BNC cable. When using RED Approved Third Party battery plates, unplug the BNC cable prior to hot swapping.

When possible, avoid using P-Tap (also known as D-Tap) cables to power accessories. To avoid damage when using P-Tap/D-Tap, it's imperative that the connect/disconnect sequence (below) is followed precisely.

## BNC ATTACHMENT INSTRUCTIONS

When attaching SDI accessories:

1. Connect a power source to the SDI accessory; power on the SDI accessory.
2. Ensure a power source is connected to the camera. This ensures both are grounded prior to connecting the BNC. The camera's power state does not have an impact on SDI attachment sequence.
3. Connect the BNC cable to the accessory, then to the camera.

When detaching an accessory mounted to an SDI output, ensure that you remove the BNC connection to the camera before removing power to the SDI device:

1. Shutdown the SDI accessory.
2. Disconnect the BNC cable from the camera.
3. Disconnect the power source from the SDI accessory.

When you need to swap out a battery on an accessory mounted to the camera's SDI port, you must:

1. Shutdown the SDI accessory.
2. Disconnect the BNC cable from the camera.
3. Replace the battery on the SDI accessory.
4. Connect the BNC cable to the camera.
5. Power on the SDI accessory.

For more information, refer to [Preventing Damage to SDI Outputs](#).



For more information about the SDI standard, refer to the SMPTE (Society of Motion Picture and Television Engineers) standard SMPTE ST-2082.

## LIVE STREAM

Use Live Stream to enable or disable live streaming over Wi-Fi. The Live Stream image is controlled by the LCD monitoring tools (the Guides are not displayed). Refer to [Monitoring Tools](#) for more information.

**NOTE:** When live streaming, select 5 GHz as the Wi-Fi band (refer to [Ad-Hoc](#)).

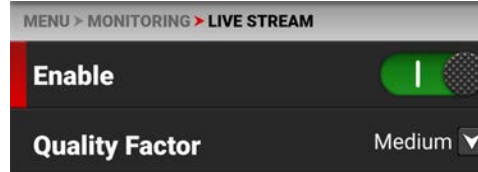
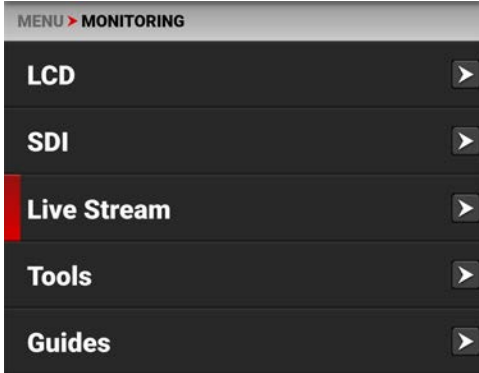

## ENABLE

Use Enable to enable or disable (default) the Live Stream feature.



## QUALITY FACTOR

Use Quality Factor, when Live Streaming is enabled, to control the video quality the camera's output stream. Lower quality can stream over a longer distance.

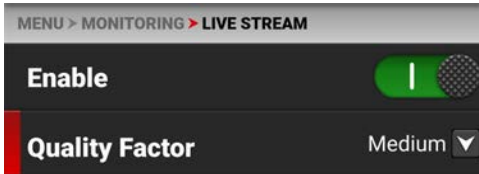

## TOOLS

The Tools menu provides access to the monitoring tools.

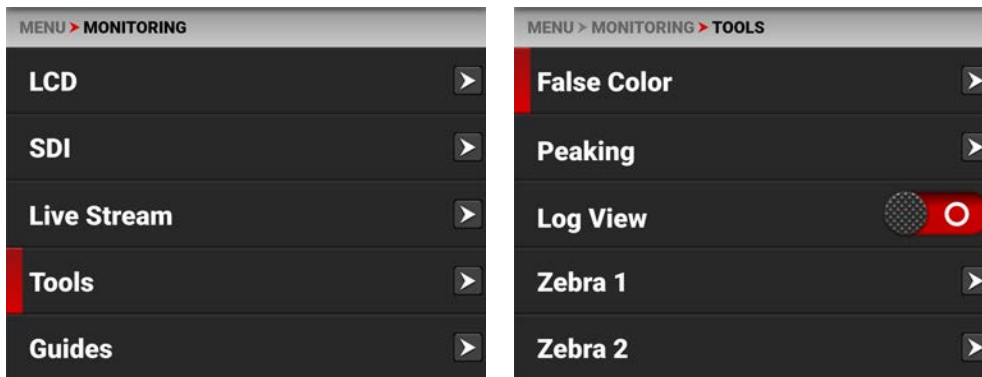

The monitoring tools that you can use include:

ITEMS	DETAILS
<b>False Color</b>	Enable and configure the <b>False Color Exposure Mode</b> and the <b>False Color Video Mode</b>
<b>Peaking</b>	Enable and configure focus indicating modes
<b>Log View</b>	Enable or disable (default) Log View
<b>Zebra 1</b>	Enable and configure Zebra 1 settings
<b>Zebra 2</b>	Enable and configure Zebra 2 settings

## FALSE COLOR

Use False Color to configure the False Color tool settings.

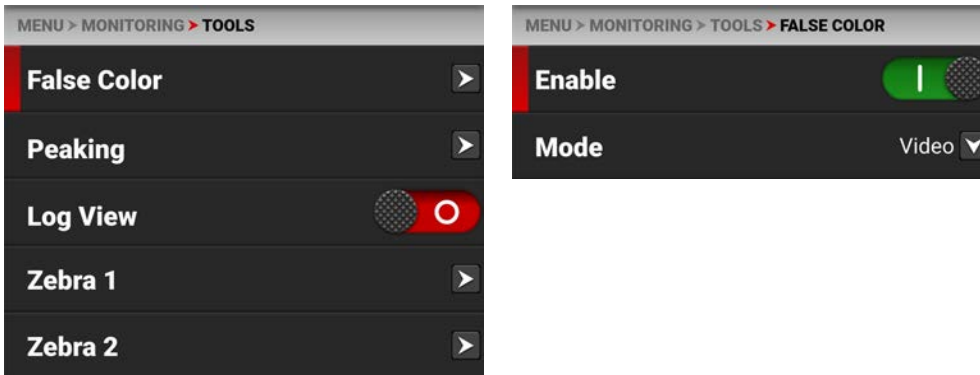

The False Color tool settings you can configure include:

ITEMS	DETAILS
Enable	Enable or disable the False Color tool modes
False Color Mode	Select the False Color tool mode

### ENABLE

Use Enable to enable or disable the False Color tool.



### FALSE COLOR MODE

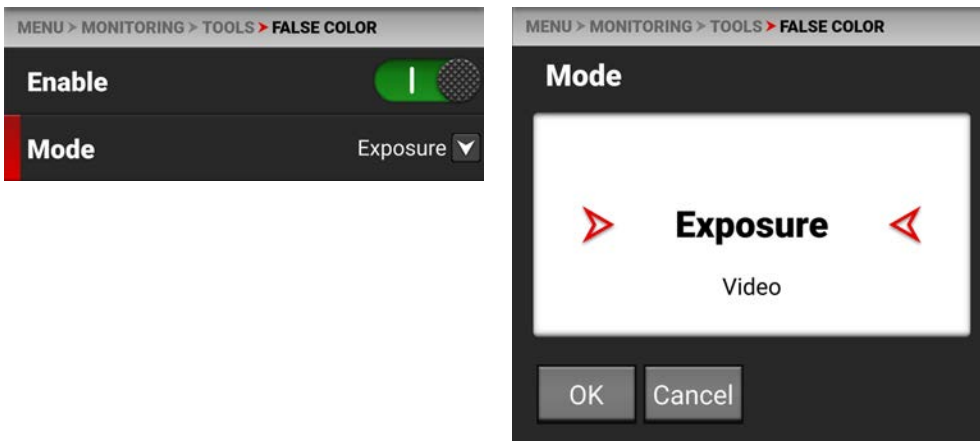

False Color Modes include:

ITEMS	DETAILS
False Color Exposure Mode	Use false colors to determine an optimal balance between overexposure and underexposure.
False Color Video Mode	Access scene exposure in varying light without relying on the LCD image brightness.

**NOTE:** False Color modes display on video recorded through SDI to an external recorder when the Tools are enabled in the Monitor menu. When recording through SDI, use False Color modes only to help determine scene exposure settings, and then disable the mode before recording.

## FALSE COLOR EXPOSURE MODE

When this monitoring **False Color** mode is activated, most of the tonal range will appear in monochrome.

The Exposure Mode is able to indicate exactly where middle gray is falling, and indicate which highlights or shadows are problematic in the logarithmic representation of the image. Exposure mode is judging the exposure after ISO and White Balance adjustments are made, and before any sort of LUT or transform is applied to the Log3G10 image.

## RED FALSE COLOR OVERLAY

When the False Color Mode overlays the color red within the subject of interest, or anywhere except bright lights and direct reflections, then the image is likely overexposed. When the False Color Mode does not overlay the color red on the image, then the exposure is likely okay for the selected ISO.

## PURPLE FALSE COLOR OVERLAY

When the False Color Mode overlays the color purple on key image detail that is not located in the shadows, then the scene is likely underexposed. When the False Color Mode does not overlay the color purple on the image, then the exposure is likely okay for the selected ISO.

For more information, refer to **Exposure** in the How To section.

## FALSE COLOR VIDEO MODE

**NOTE:** For best results, Video Mode should be viewed at or above ISO 800.

Video Mode displays a color overlay that indicates the video level of the RGB monitor path (calibrated to the SMPTE test signal).

The colors used are based on the RGB levels of the video out signal (that is, the “cooked” look, and not RAW data). The camera's RGB settings can change the appearance of the Video Mode colors.

The Video Mode colors represent the following IRE values (at all other values, the desaturated image represents the luminance value of the ISO adjusted image):

- Purple: IRE 0–4
- Blue: IRE 5
- Teal: IRE 10–12
- Green: IRE 41–48
- Pink: IRE 61–70
- Straw: IRE 92–93
- Yellow: IRE 94–95
- Orange: IRE 96–98
- Red: IRE 99–100

For more information, refer to **Exposure** in the How To section.

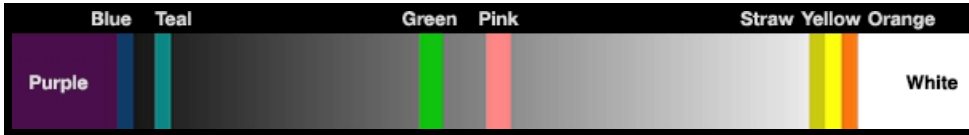

Green is where you will want 18% gray, Pink is typically the brightness of Caucasian skin tones, Straw, Yellow, and Orange are strong highlights and increasingly closer to white, Teal is deep shadows and Blue is on the verge of becoming untextured black. In general, Pink and Green are most helpful when calibrating based on a known reference, whereas the other colors indicate the extremes of a tonal range.

A potential disadvantage of False Color Video mode is that all the false colors can distract from the underlying preview. Many prefer to use this mode only during initial set-up, and then they use **False Color Exposure Mode** under a wider range of scenarios.

## IN PRACTICE

In **False Color Exposure Mode**, use the purple and red indicators to adjust your lighting or lens aperture. Use this strategy to achieve an optimal balance between clipping from overexposure and image noise from underexposure. With most scenes, you can often have a surprising range of exposure latitude before excessive red or purple indicators begin to appear.

If necessary, use False Color Video mode or **Zebra Modes** to fine-tune how the scene will appear over SDI, or use it to adjust your suggested look when sending footage for post-production.

The Zebra and Video modes are also an objective way to assess the scene exposure under varying ambient light without relying on the LCD image to evaluate brightness.

## PEAKING

The Peaking tools display contrast, outlines, or colors to assist with focusing.

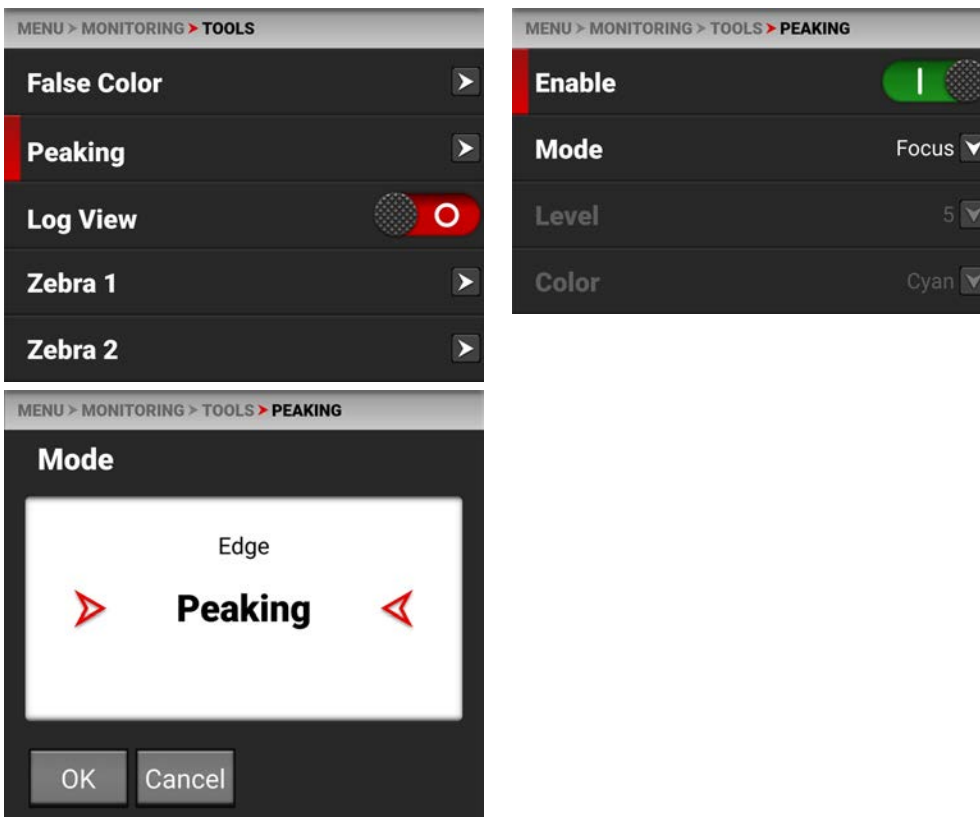

The Peaking modes you can use include:

ITEMS	DETAILS
Focus	Use enhanced contrast and edges for focusing
Edge	Show outlines of focused objects
Peaking	Select a colored overlay to indicate objects in focus

## FOCUS PEAKING MODE

Focus Peaking mode emphasizes contrast and edges in the image without changing the brightness or the image content. This mode makes it easier to judge focus. Adjust the zoom and focus to easily see which objects are coming into focus.

## EDGE PEAKING MODE

When you enable Edge Peaking mode, the display shows the edges or outlines of objects that are in focus.

## PEAKING PEAKING MODE

The Peaking Peaking mode displays a color overlay on top of in-focus edges. Select a Level of 1 to 10 (weak to strong) for the intensity of the color overlay. The RGB settings can change the appearance of the selected color overlay.

The Peaking Peaking mode indicator is applied after the image is scaled to a monitor, making the indicators appear differently on various monitors.

For more information about Peaking, refer to [Focus](#) in the How To section.

## LOG VIEW

Use Log View to display camera images in REDWideGamutRGB and Log3G10 for the ISO, Exposure Adjust, Color Temperature, and Tint settings. This allows you to quickly see ungraded footage that remains unaffected by creative decisions such as the choice of 3D LUT or CDL.

Log View is passed through the SDI port when recording to an external recorder. You can view the Log image in playback on the LCD and on the monitor. However, Log View is not recorded to the file recorded on the media card.

Log View is only enabled on R3D files and not on ProRes files.

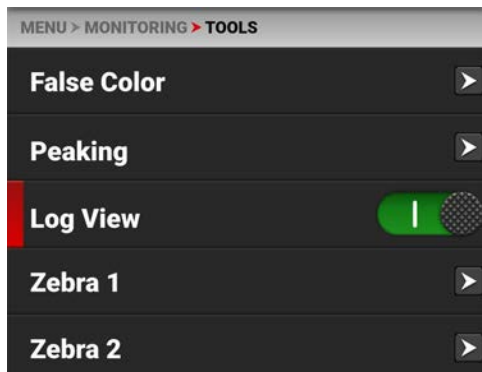

Use the slider to switch from Enabled to Disabled:





## ZEBRA 1

Use Zebra 1 to display one set of diagonal stripes to indicate highlight exposure levels. For more information, refer to [Zebra Modes](#).

Zebra 1 is disabled by default.

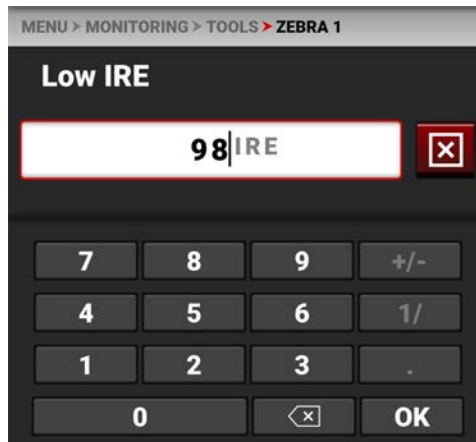
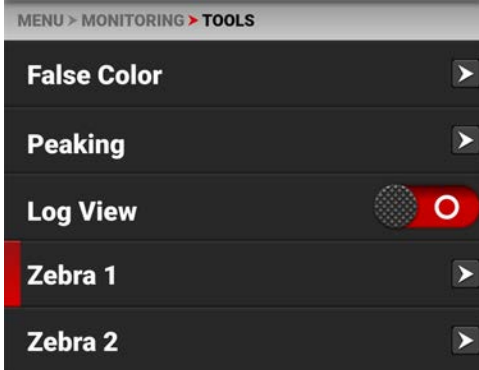

The Zebra 1 mode includes:

ITEMS	DETAILS
Enable	Enables red zebra stripes to indicate highlight exposure
Low IRE	Sets the lower threshold for the indicator
High IRE	Sets the higher threshold for the indicator

## ENABLE

The Enable toggle switch allows you to enable or disable the Zebra 1 stripes.

## LOW IRE

Provides a keypad that allows you to set the low threshold for the Zebra stripe. The default setting is 98 IRE.

## HIGH IRE

Provides a keypad that allows you to set the high threshold for the Zebra stripe. The default setting is 100 IRE.

### NORMAL VIEW



### ZEBRA 1 VIEW



## ZEBRA 2

Use Zebra 2 to display a second set of diagonal stripes to indicate mid-tone and shadow levels. For more information, refer to [Zebra Modes](#).

Zebra 2 is disabled by default.

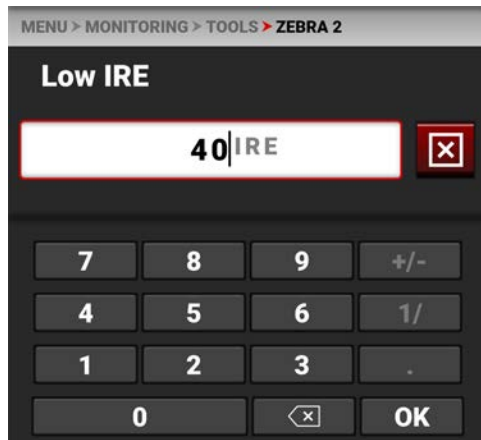
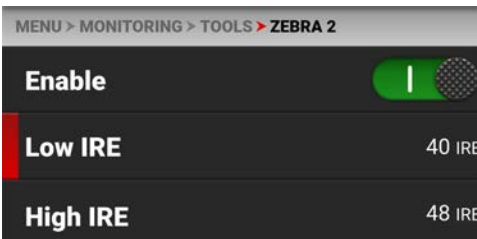
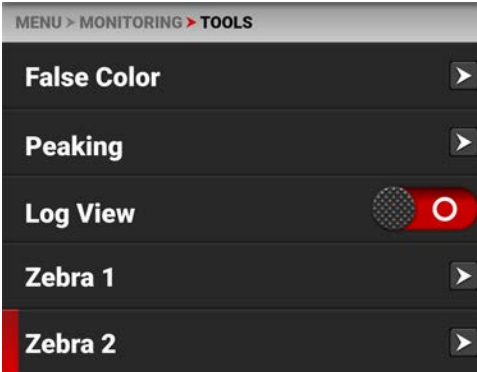

The Zebra 2 mode includes:

ITEMS	DETAILS
Enable	Enables green zebra stripes to indicate mid-tone and shadow exposure
Low IRE	Sets the lower threshold for the indicator
High IRE	Sets the higher threshold for the indicator

## ENABLE

The Enable toggle switch allows you to enable or disable the Zebra 2 stripes.

## LOW IRE

Provides a keypad that allows you to set the low threshold for the Zebra stripe. The default setting is 40 IRE.

## HIGH IRE

Provides a keypad that allows you to set the high threshold for the Zebra stripe. The default setting is 48 IRE.

### NORMAL VIEW

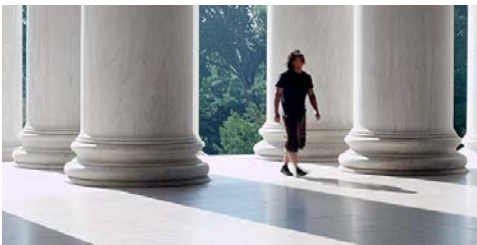

### ZEBRA 1 VIEW

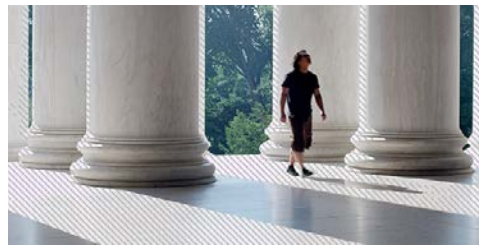

### ZEBRA 2 VIEW

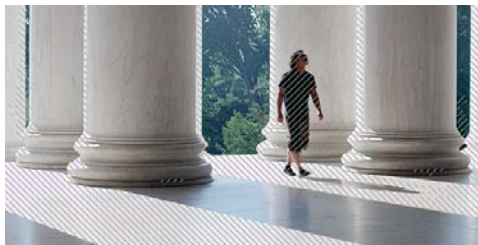

## GUIDES

Use Guides to enable and configure the camera's monitoring guides.

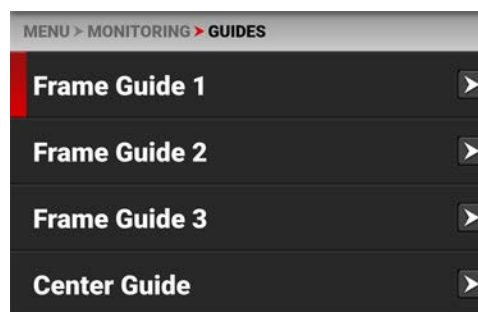
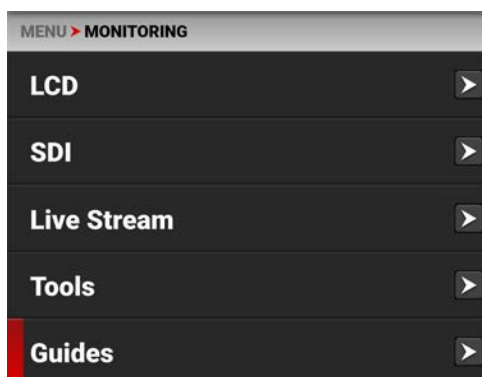

The monitoring Guides that you can use include:

ITEMS	DETAILS
Frame Guides	Guides you can configure to aid in framing a shot
Center Guide	A center cross hair or dot you can use to center your shot

## FRAME GUIDES

Use Frame Guides to frame the scene using various shapes and sizes. You can configure up to 3 Frame Guides to display on your monitor.

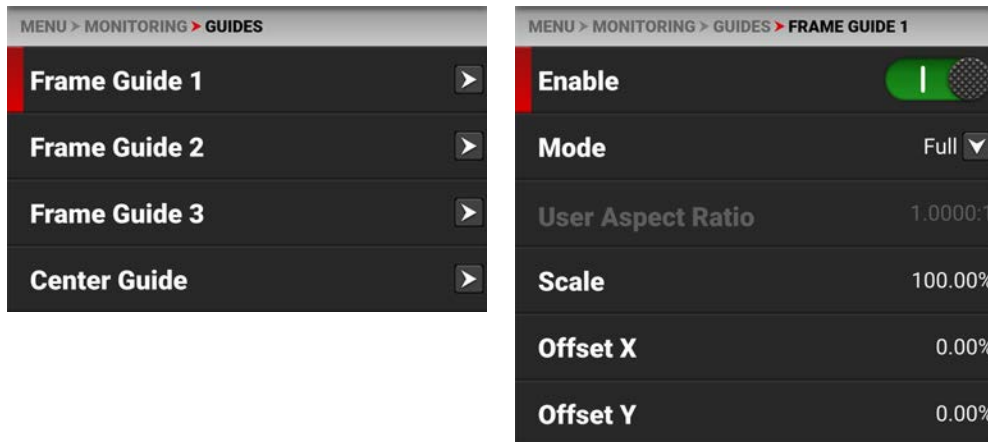

Configure the Frame Guides using the following:

ITEMS	DETAILS
Enable	Enables the Frame Guide
Mode	Select aspect ratios, User, and Absolute modes
User Aspect Ratio	Enabled by selecting User mode
Scale	Percentage of the image the Frame Guide occupies
Offset X, Y	Percentage of horizontal and vertical offset
Absolute X, Y, W, H	Absolute mode - set the exact number of size and offset pixels
Line Style	Select the Frame Guide line type - solid, dashed or bracket
Line Color	Select the Frame Guide line color
Line Opacity	Select the Frame Guide line opacity percentage

## MODE

Use Mode to select the Frame Guide mode you want to use to configure the frame guide.

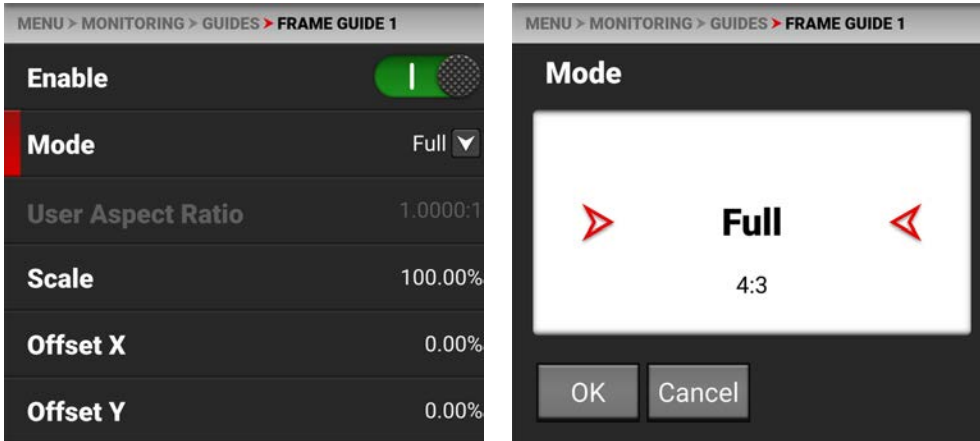

The modes you can select include aspect ratios from Full to 2.4:1, User, and Absolute. The User and Absolute modes enable settings that are specific to those modes.

## USER ASPECT RATIO

This item is enabled when the User mode is selected.

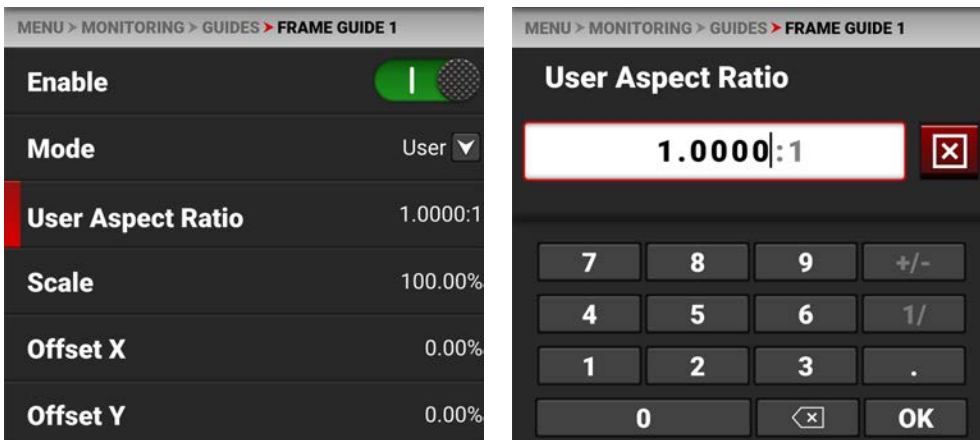

Use the keypad to enter your desired aspect ratio.

## SCALE

Use scale to configure the percentage of the image area that the Frame Guide will frame.

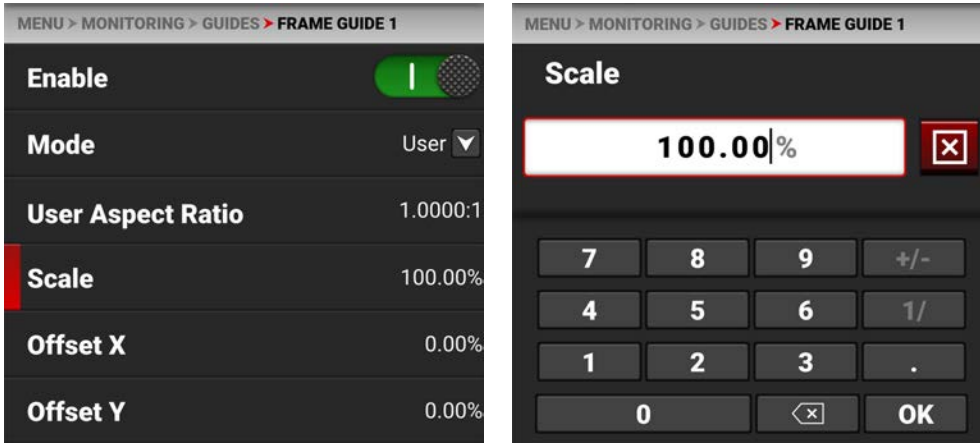

Use the keypad to enter the percentage of the image the Frame Guide contains.

## OFFSET X, Y

Use offset to configure the X and Y offset of the Frame Guide.

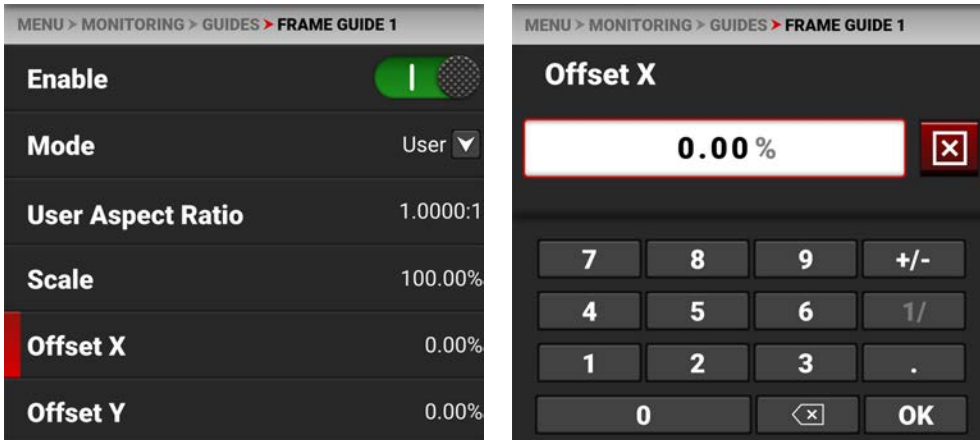

Use the keypad to enter the percentage of offset from center you want to apply to the Frame Guide.

## ABSOLUTE X, Y, W, H

Use the Absolute settings to configure the absolute dimensions and position of the Frame Guide.

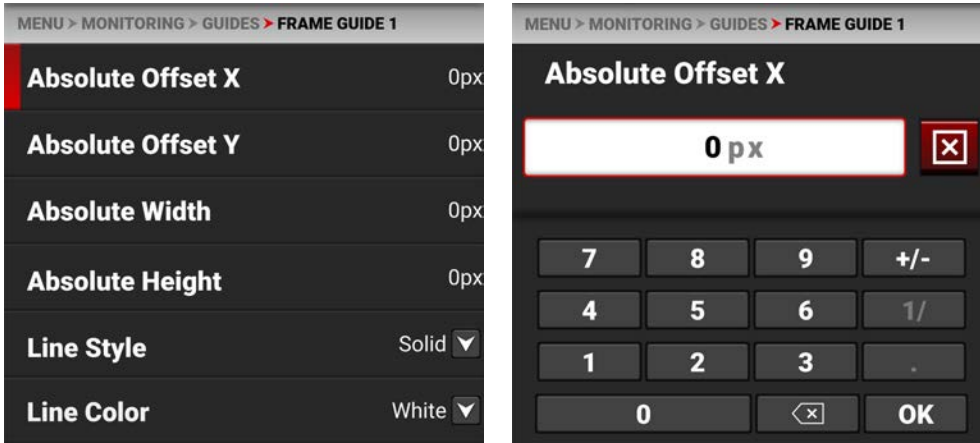

Use the keypad to enter the number of pixels for X/Y offset and for the width and height of the Frame Guide. The Absolute items are only enabled when you select Absolute **Mode**.

## LINE STYLE

Use Line Style to select the type of line the Frame Guide uses.

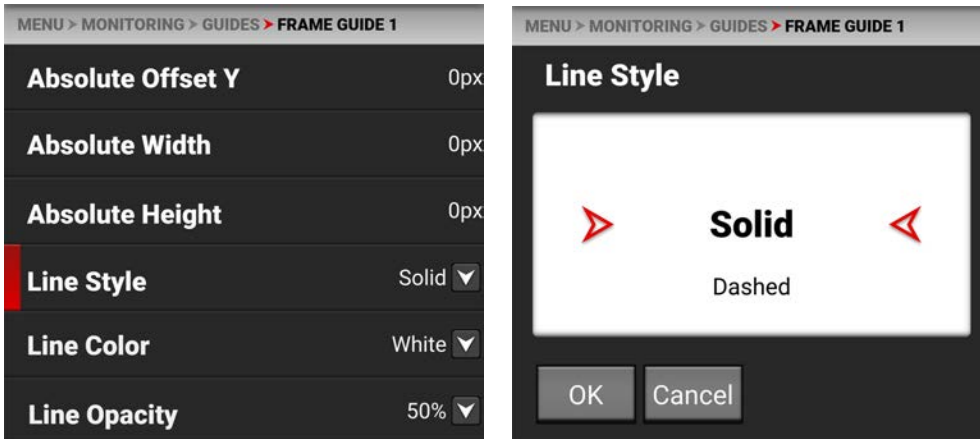

Select Solid (default), Dashed, or Bracket for the Frame Guide line style.

## LINE COLOR

Use Line Color to select the color of the Frame Guide line.

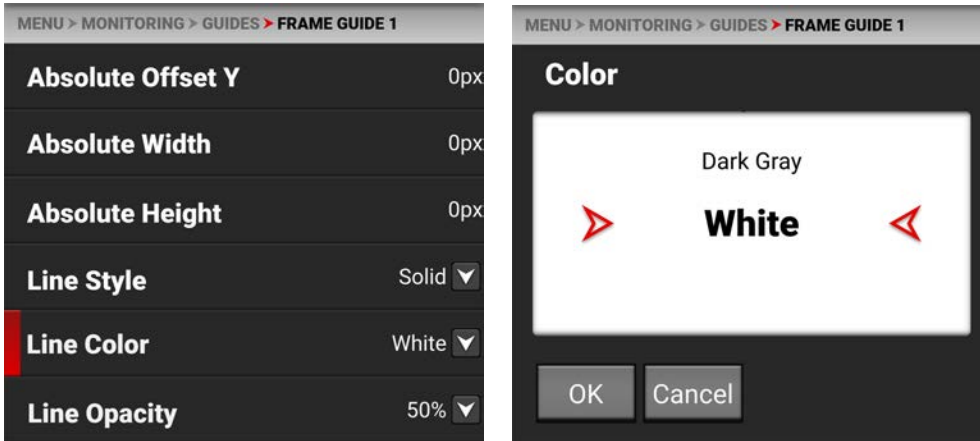

Use Line Color to select one of the following colors for the Frame Guide line:

- Black
- Red
- Blue
- Green
- Yellow
- Magenta
- Cyan
- Dark Gray
- White (default)

## LINE OPACITY

Use Line Opacity to select how transparent the Frame Guide line appears.

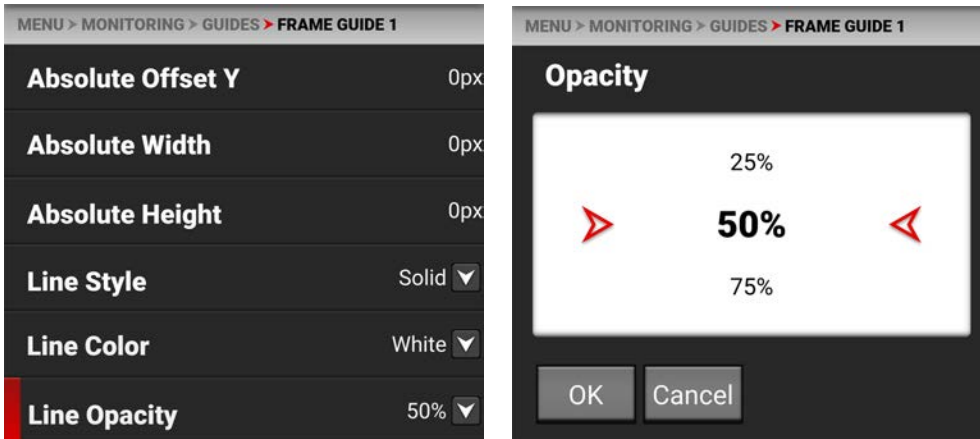

Use Line Opacity to select the percentage of opacity for the Frame Guide line:

- 25%
- 50% (default)
- 75%
- 100%



## CENTER GUIDE

Use Center Guide to enable and configure the Center Guide.

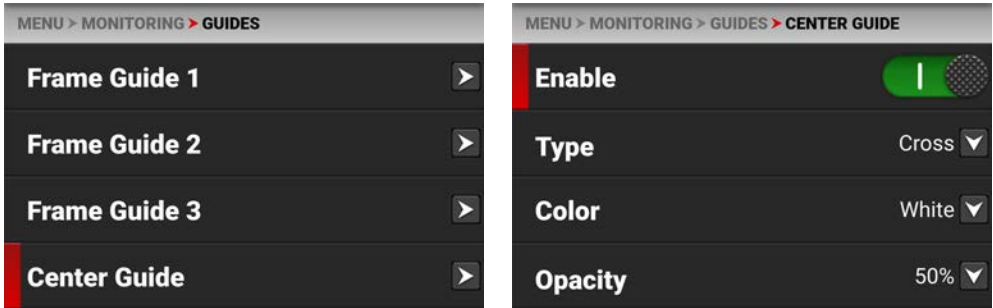

Configure the Center Guide by using the following:

ITEMS	DETAILS
Enable	Enables the Center Guide
Type	Select Center Guide type - dot or cross
Color	Select a color for the Center Guide
Opacity	Percentage of opacity of the guide color

## TYPE

Use Type to select the type of Center Guide to display.

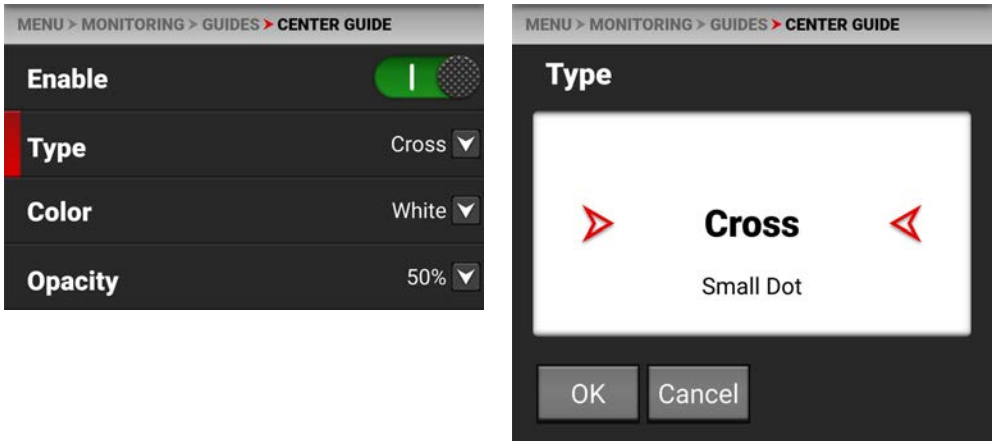

Use Type to select a center dot or cross (default) for the Center Guide.

## COLOR

Use Color to select the color used by the Center Guide.

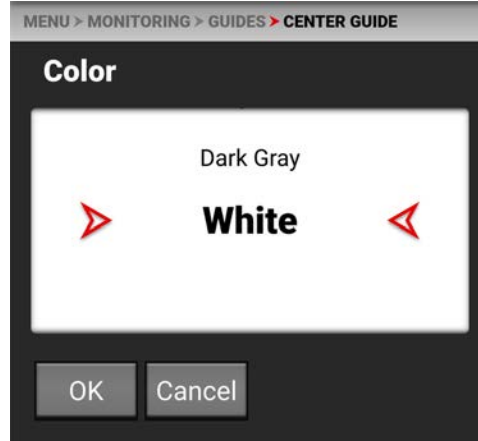
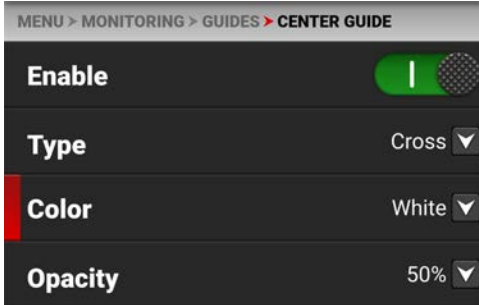

Use Color to select one of the following colors for the Center Guide:

- Black
- Green
- Cyan
- Red
- Yellow
- Dark Gray
- Blue
- Magenta
- White (default)

## OPACITY

Use Opacity to select how transparent the Center Guide appears.

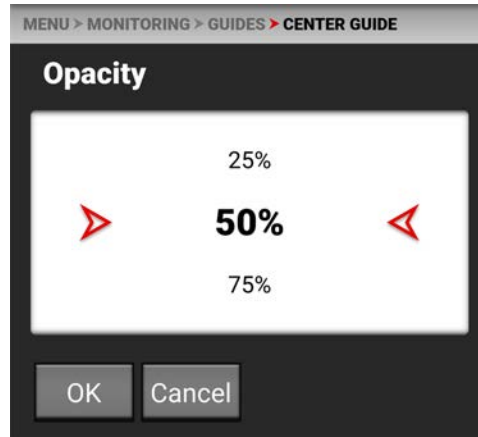
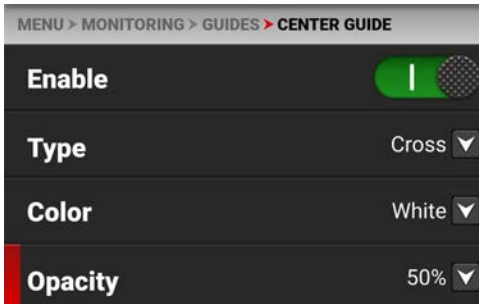

Use Opacity to select the percentage of opacity for the Center Guide:

- 25%
- 50% (default)
- 75%
- 100%

## MEDIA MENU

The Media menu contains the settings you use to configure your media.

From the camera LCD touchscreen menu, select Media:

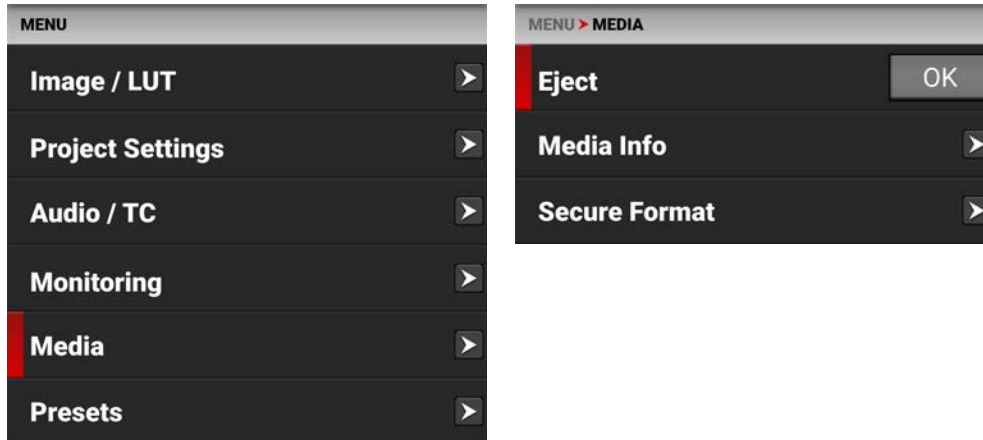

Use the Media menu to configure the camera's storage media settings and to view the media information:

ITEMS	DETAILS
Eject	Eject the CFast media card
Media Info	View the CFast media card information
Secure Format	Performs a secure format of the CFast media card

## EJECT

Use Eject to safely unmount the CFast media card electronically from the camera before removing it physically.

**WARNING:** The media can get extremely hot. Use caution when removing media.

**WARNING:** Do not attach a label to the CFast media card. The heat generated by the media can weaken the label's adhesive, causing the label to detach inside of the camera. Labels can also diminish heat dissipation and cause excessive wear to the internal components. Removing a label from a CFast media card can possibly deform the card body.

Access Eject from the [LCD Touchscreen](#) Media menu:



For more information, refer to [Media Management](#).

## MEDIA INFO

Use Media Info to display the CFast media card information.

Access Media Info from the **LCD Touchscreen** Media menu:

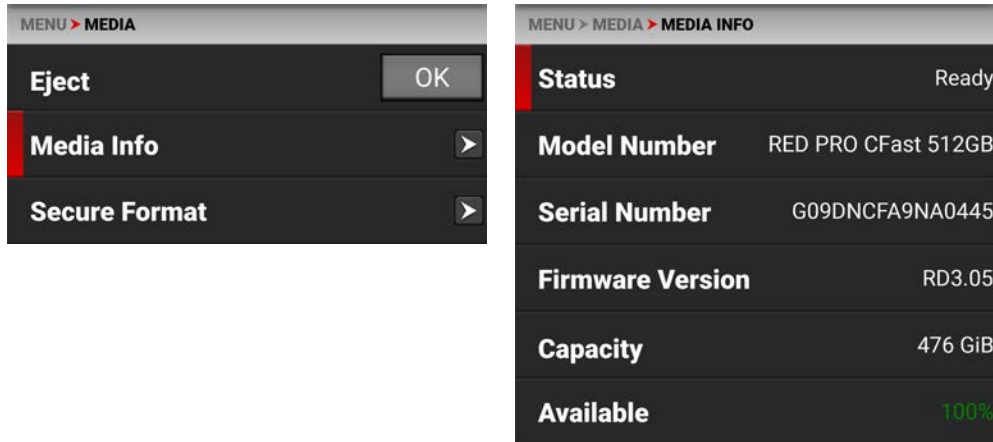

Media Info displays the following:

SETTING	DETAILS
Status	Displays the CFast media card status
Model Number	Displays the CFast media card model number
Serial Number	Displays the CFast media card serial number
Firmware Version	Displays the CFast media card firmware version
Capacity	Displays the CFast media card total capacity
Available	Displays the CFast media card's remaining storage
Time Remaining	Displays the recording time remaining on the CFast media card

## SECURE FORMAT

Use Secure Format to format the CFast media card down to the file system level.

A secure format allows you to rebuild the card file system.

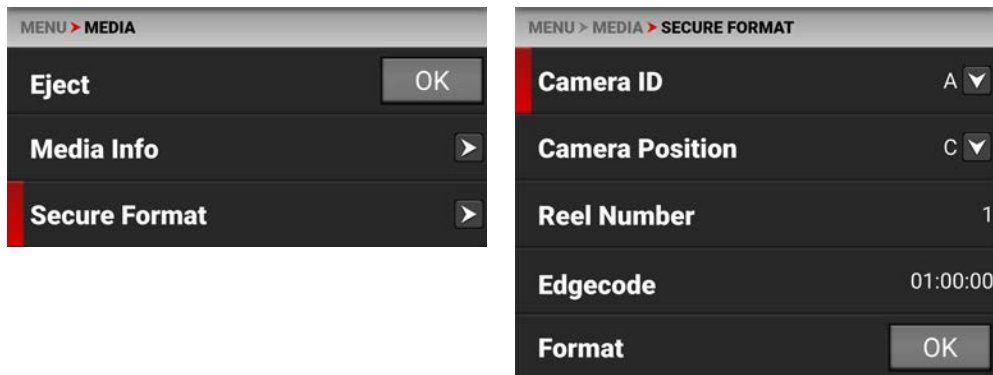

Use the Secure Format menu to update the following information:

SETTING	DETAILS
Camera ID	Select the camera ID (default is A)
Camera Position	Select the camera position (default is C)
Reel Number	Select the reel number (default is 1)
Edgecode	Enter the time number (default is 01:00:00)
Format	Starts the Secure formatting process

For more information, refer to [Secure Format](#).

## CAMERA ID

Use Camera ID to assign a camera ID letter to the media.

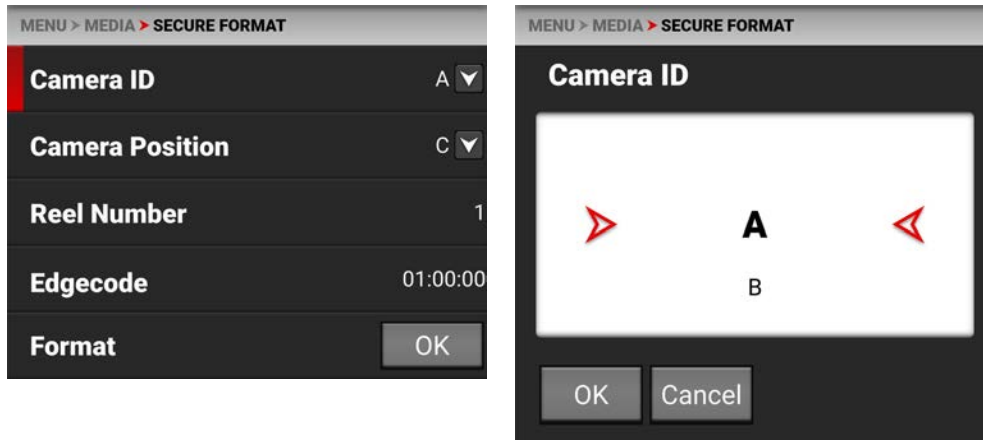

The Camera ID letters you can assign range from A-Z. For more information, refer to [Secure Format](#).

## CAMERA POSITION

Use Camera Position to select the camera position label for the CFast media card.

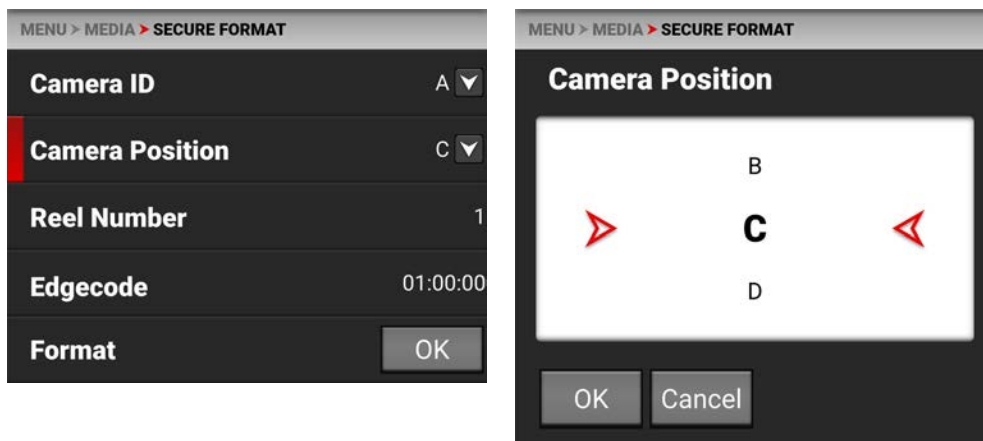

The Camera Position letters you can assign range from A-Z. For more information, refer to [Secure Format](#).

## REEL NUMBER

Use Reel Number to assign a reel number to the media.

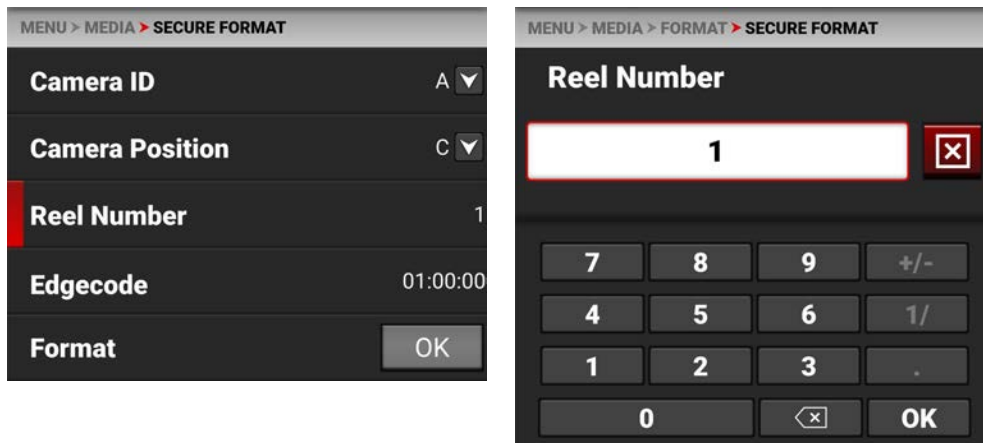

Use the keypad to enter a unique reel number to the media.

**NOTE:** It is best practice to keep your reel numbers to no longer than seven characters in length to conform with all EDL formats.

For more information, refer to [Secure Format](#).

## EDGECODE

Use Edgecode to assign an edge code to the media.

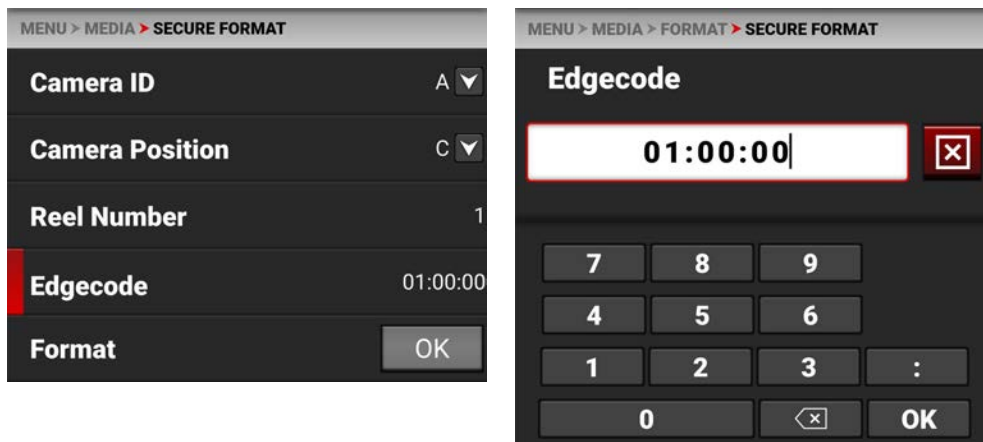

Use the keypad to enter a unique edge code number to the media.

Edge Code is a SMPTE Timecode track that by default starts at 01:00:00 on the first frame of each CFast media card. It is a sequential code that is continuous from frame to frame and also between clips. Edge Code is equivalent to RUN RECORD as used on broadcast cameras.

For more information, refer to [Secure Format](#).

## FORMAT

Use Format to execute a secure format of the media.

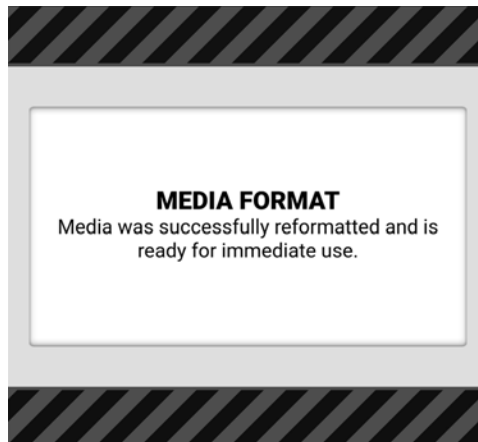
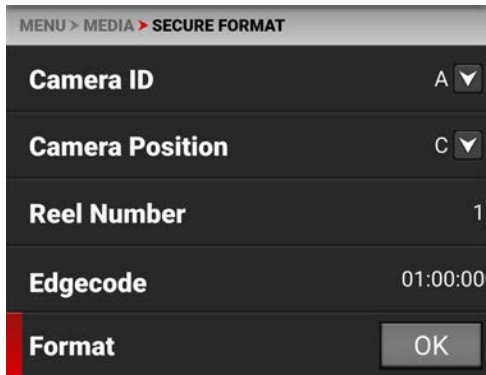

For more information, refer to [Secure Format](#).

## PRESETS MENU

The Presets menu contains the settings you use to quickly set up your camera.

From the camera LCD touchscreen menu, select Presets:

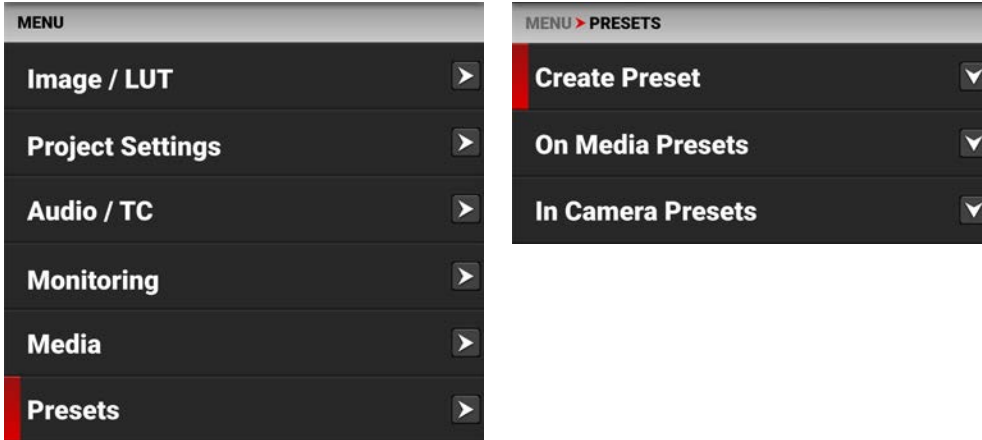

Use the Presets menu to build and select pre-configured settings for the camera:

ITEMS	DETAILS
Create Preset	Create camera setting presets
On Media Presets	Manage presets stored on the media
In Camera Presets	Manage presets stored in the camera

## CREATE PRESET

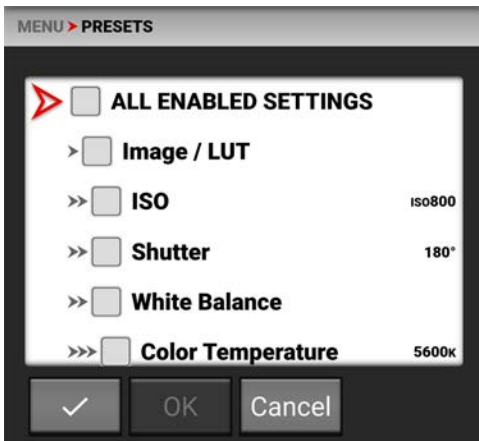



Use Create Preset to select the current camera settings you want to use to create a preset list of settings. You can select settings individually:

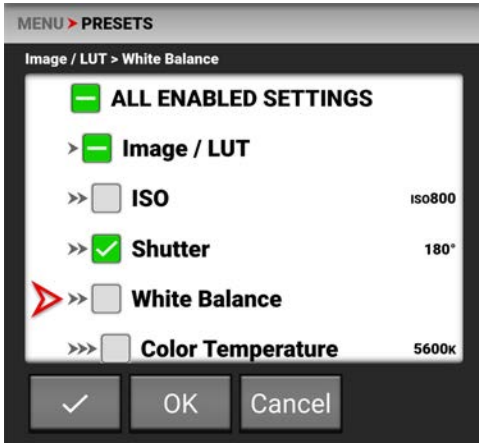

You can also use the ALL ENABLED SETTINGS checkmark button to select all of the current camera settings as a preset:

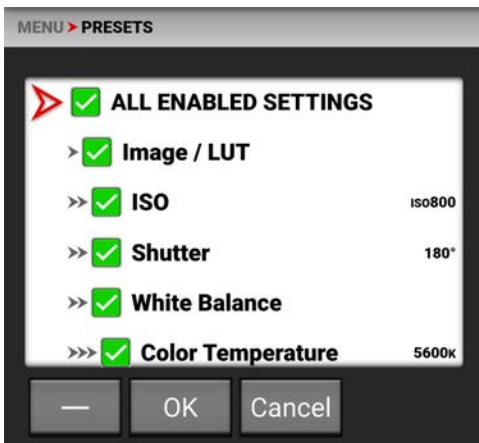

Click OK to create the preset. The Create Preset screen opens.

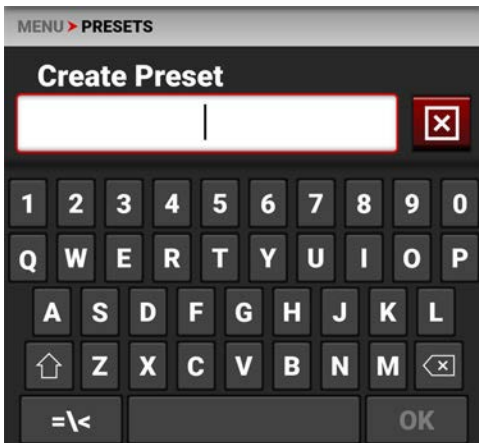

Use the Create Preset screen to name the preset.

## ON MEDIA PRESETS



You can import presets from the media to the camera. When importing presets from the media to the camera, the presets are saved to a folder on the camera called “presets”.

From On Media Presets, you can import the selected preset from the media to the camera or import all of the presets from the media to the camera.

## IN CAMERA PRESETS

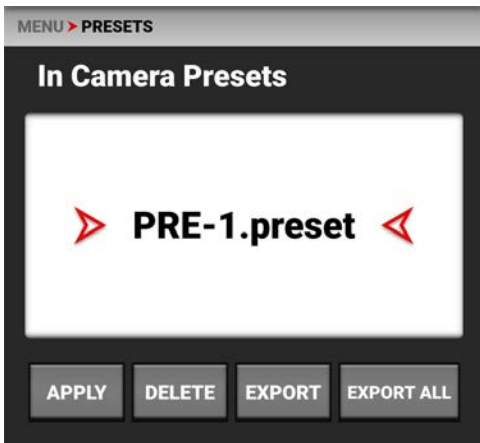

You can export presets from the camera to the media. When exporting presets from the camera to the media, the presets are saved to a folder on the media called “presets”.

From In Camera Presets, you can apply the selected preset to the camera, delete the selected preset from the camera, export the selected preset from the camera to the media, or export all of the presets from the camera to the media.

## AUTOFOCUS - BETA MENU

Use Autofocus to enable and configure the camera's Autofocus feature. The lens must support autofocus for this feature to work.

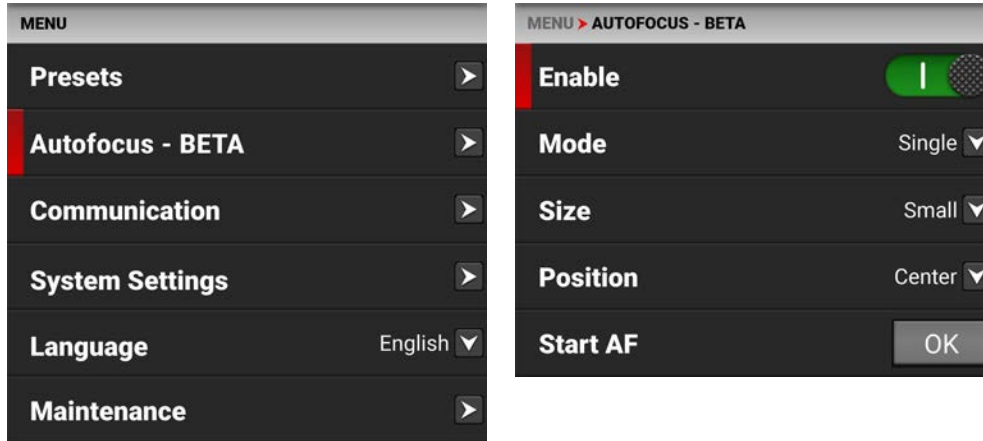

Use the Autofocus menu to perform camera autofocus tasks:

ITEM	DETAILS
Enable	Enable/Disable the autofocus feature
Mode	Select the autofocus mode
Size	Select the size of the autofocus area
Position	Select the position of the autofocus area
Start AF	Button that you tap to start the Autofocus feature

## ENABLE

Use Enable to enable or disable the **Autofocus - BETA Menu** feature. The lens must support autofocus for the camera to use this feature.

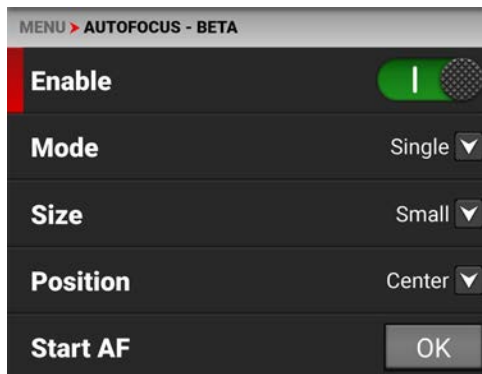

## MODE

Use Mode to select the autofocus mode for the camera. The lens must support autofocus for the camera to use this feature.

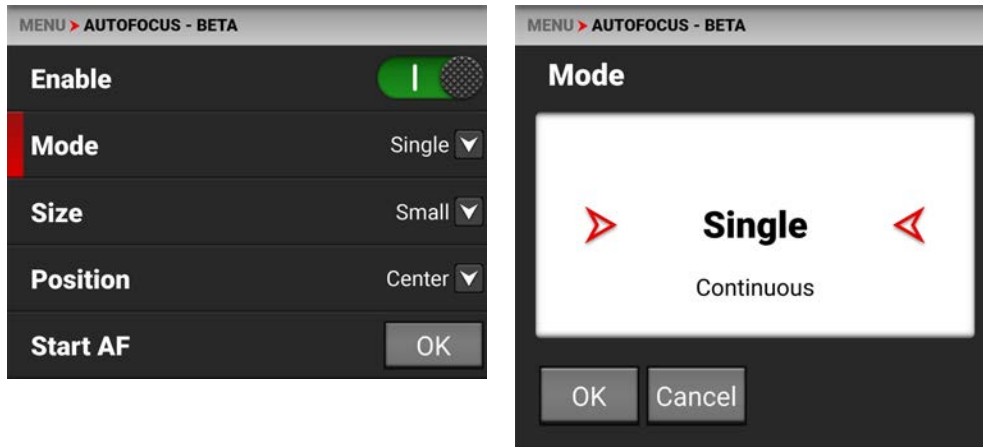

### SINGLE MODE (DEFAULT)

Use single mode to autofocus and then stop at that focus position.

### CONTINUOUS MODE

Use Continuous mode to continue to change focus to keep a moving subject in focus.

## SIZE

Use Size to choose what size area you want the camera to use for the autofocus feature. The lens must support autofocus for the camera to use this feature.

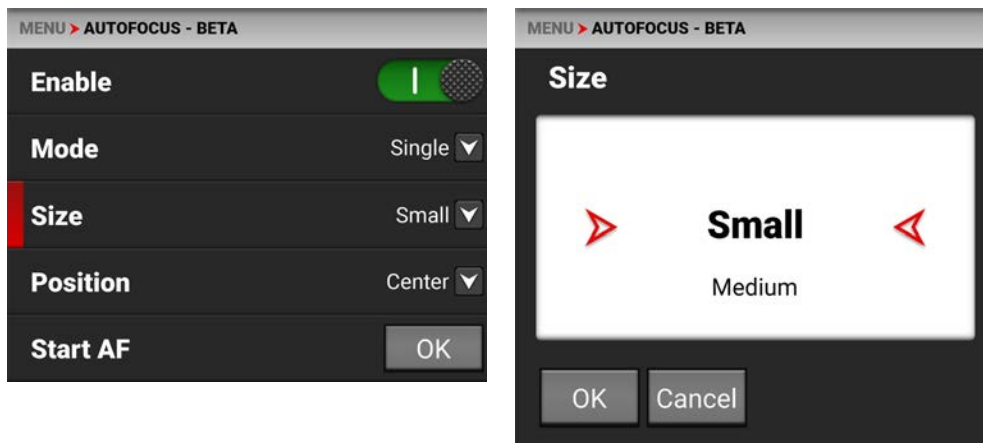

The Size selections for the autofocus area are Small (default), Medium, Large, Wide, and Vertical.

## POSITION

Use Position to specify the position of the autofocus area on the sensor. The lens must support autofocus for the camera to use this feature.

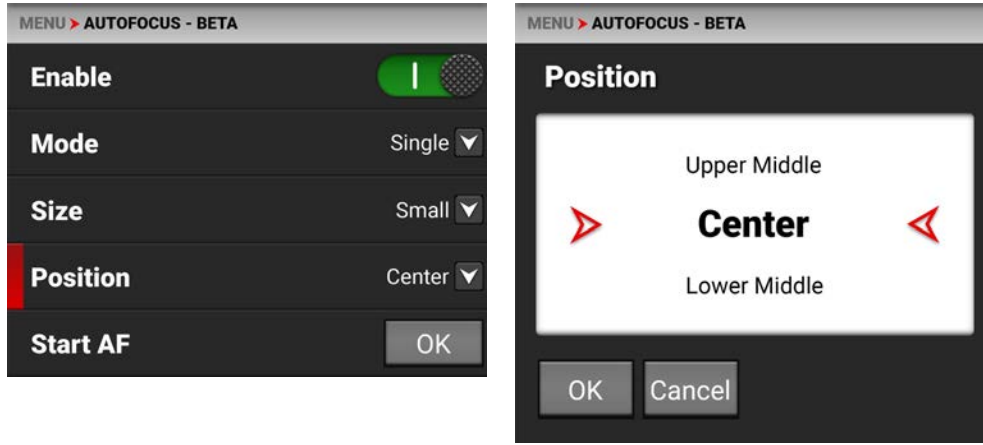

The Position selections include:

- Left
- Upper Middle
- Upper Right
- Upper Left
- Center (default)
- Lower Right
- Lower Left
- Lower Middle
- Right

The Autofocus Position rectangle displays on the screen:



You can move the position manually on the LCD screen. The menu will change to display Custom.

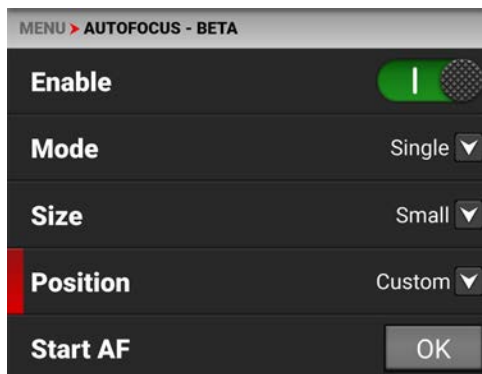

## COMMUNICATION MENU

The Communication menu contains the settings you use to configure your camera to communicate with other devices.

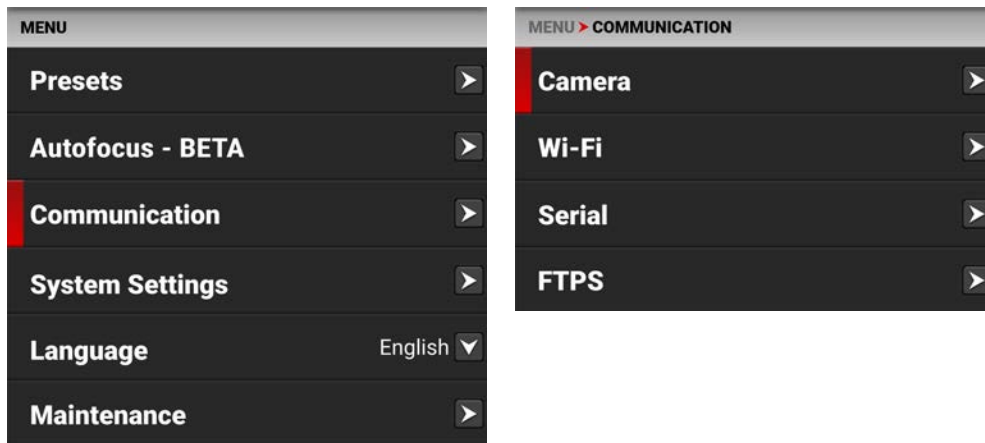

Use the Communication menu to configure the camera's communication settings:

ITEMS	DETAILS
Camera	Setting for the camera name
Wi-Fi	Settings for Wi-Fi communication
Serial	Settings for the <b>Extension Port</b> serial connection
KOMODO Link Adaptor*	IP address for linked device
FTPS	File transfer protocol secure settings

\*Requires **KOMODO Link Adaptor**

## CAMERA

Use the Camera Communication menu to select the camera communication settings.

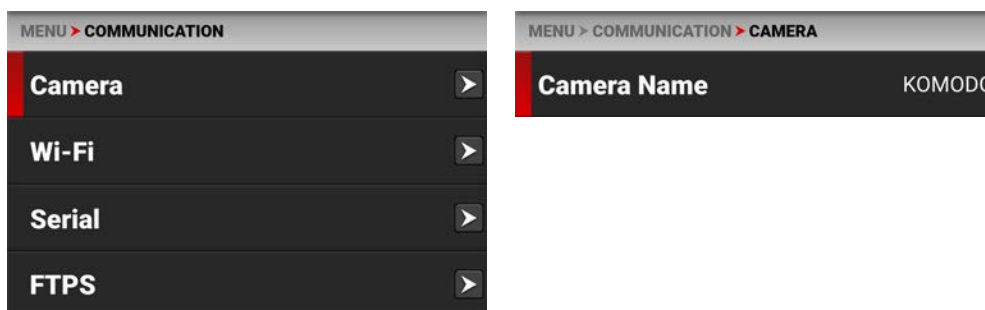

Use the Camera communication settings to configure the camera name.

## CAMERA NAME

Use Camera name to enter a camera name.

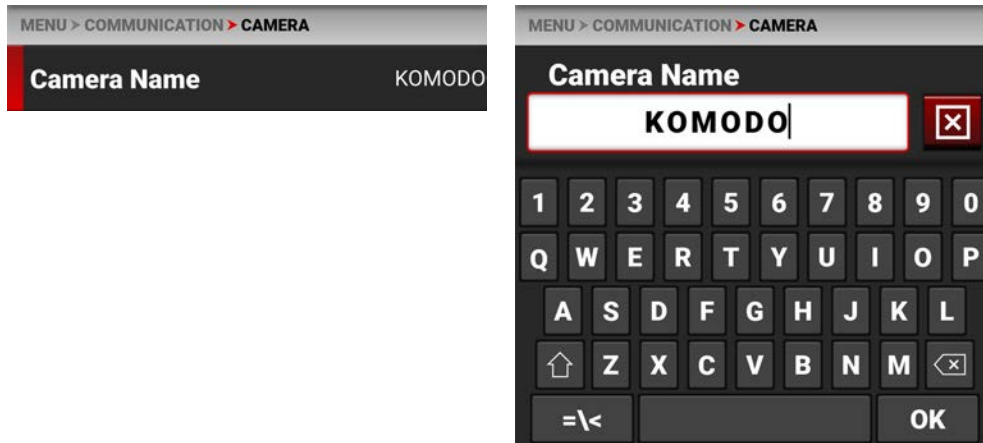

## WI-FI

Use Wi-Fi to configure the camera to work with a Wi-Fi connection.

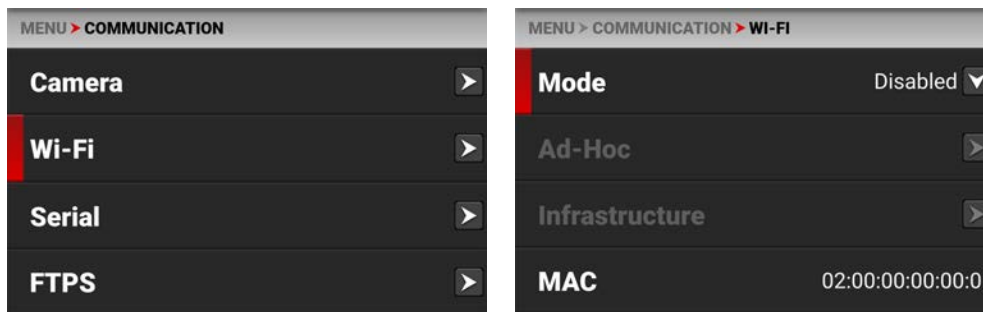

Use the Wi-Fi menu to configure the camera's Wi-Fi settings:

ITEMS	DETAILS
Mode	Disable Wi-Fi or select the camera Wi-Fi settings
Ad-Hoc	Configure the camera as a Wi-Fi hot spot
Infrastructure	Settings for connecting to an existing Wi-Fi network
MAC	Displays the camera device MAC address

## MODE

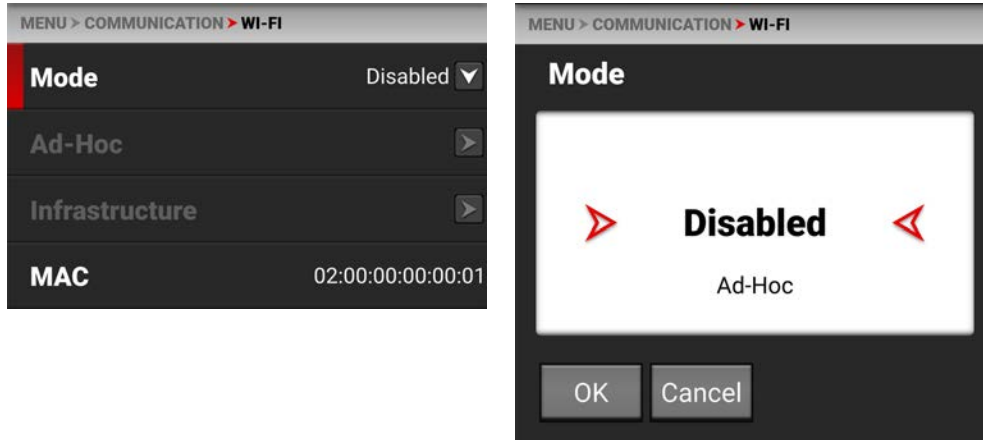

From Mode you can disable the Wi-Fi network, or you can enable the camera's **Ad-Hoc** or **Infrastructure** Wi-Fi settings. The default setting is Disabled.

## AD-HOC

Use Ad-Hoc to configure the camera as a Wi-Fi hot spot.

**NOTE:** The Ad-Hoc menu is enabled when the **Wi-Fi Mode** is set to **Ad-Hoc**.

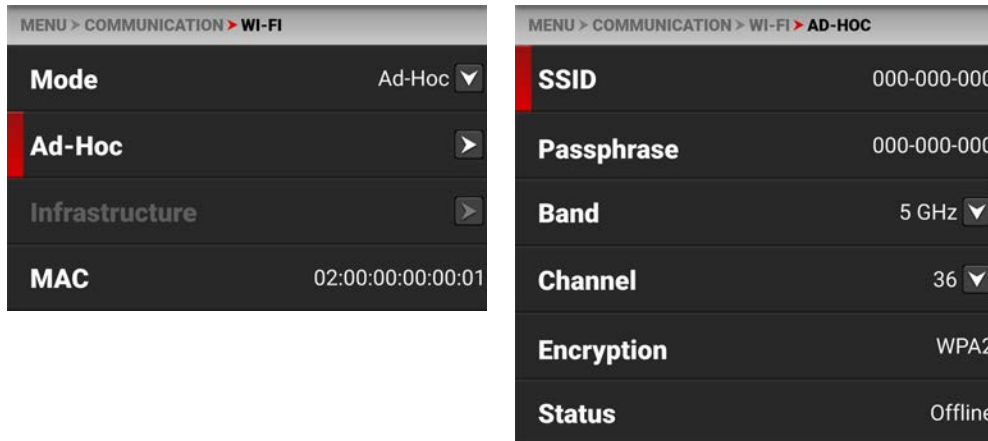

Use the Ad-Hoc menu to configure the Wi-Fi hot spot settings:

ITEMS	DETAILS
SSID	Enter the name of the Wi-Fi network the camera generates
Passphrase	Enter the password for the Wi-Fi network
Band	Select the Wi-Fi frequency band
Channel	Select the optimal channel for the Wi-Fi band
Encryption	Displays the encryption type
Status	Displays the connection status
IP Address	Displays the IP address
Netmask	Displays the Netmask



## SSID

MENU > COMMUNICATION > WI-FI > AD-HOC	
<b>SSID</b>	000-000-000
<b>Passphrase</b>	000-000-000
<b>Band</b>	5 GHz ▾
<b>Channel</b>	36 ▾
<b>Encryption</b>	WPA2
<b>Status</b>	Offline

MENU > COMMUNICATION > WI-FI > AD-HOC	
<b>SSID</b>	000-000-000 <input type="button" value="X"/>
1 2 3 4 5 6 7 8 9 0	
Q W E R T Y U I O P	
A S D F G H J K L	
⏪ Z X C V B N M ⏩	
= \ < <input type="button" value="OK"/>	

Use the keypad to enter the camera's Wi-Fi network name.

## PASSPHRASE

MENU > COMMUNICATION > WI-FI > AD-HOC	
<b>SSID</b>	000-000-000
<b>Passphrase</b>	000-000-000
<b>Band</b>	5 GHz ▾
<b>Channel</b>	36 ▾
<b>Encryption</b>	WPA2
<b>Status</b>	Offline

MENU > COMMUNICATION > WI-FI > AD-HOC	
<b>Passphrase</b>	000-000-000 <input type="button" value="X"/>
1 2 3 4 5 6 7 8 9 0	
Q W E R T Y U I O P	
A S D F G H J K L	
⏪ Z X C V B N M ⏩	
= \ < <input type="button" value="OK"/>	

Use the keypad to enter the camera's Wi-Fi passphrase.

## BAND

MENU > COMMUNICATION > WI-FI > AD-HOC	
SSID	000-000-000
Passphrase	000-000-000
<b>Band</b>	5 GHz ▾
Channel	36 ▾
Encryption	WPA2
Status	Offline

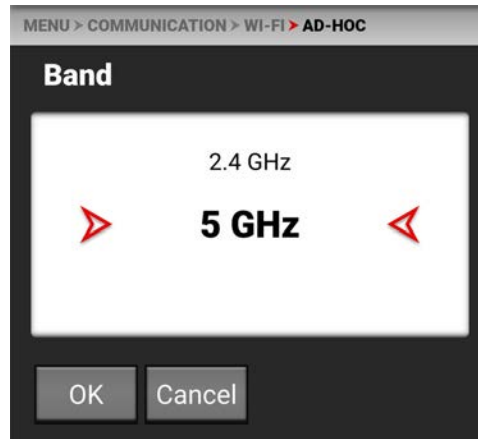

Select the camera's Wi-Fi network frequency band.

- Use 5 GHz for optimal wireless video streaming performance (default)
- Use 2.4 GHz for long range remote control (when not utilizing wireless video streaming)

## CHANNEL

MENU > COMMUNICATION > WI-FI > AD-HOC	
SSID	000-000-000
Passphrase	000-000-000
Band	5 GHz ▾
<b>Channel</b>	36 ▾
Encryption	WPA2
Status	Offline

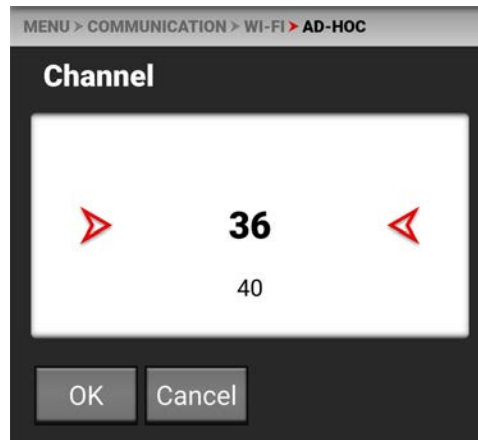

Select the optimal channel for the selected band, one which receives the least interference from the surrounding Wi-Fi signals.

## ENCRYPTION

MENU > COMMUNICATION > WI-FI > AD-HOC	
SSID	000-000-000
Passphrase	000-000-000
Band	5 GHz ▾
Channel	36 ▾
<b>Encryption</b>	WPA2
Status	Offline

The camera uses WPA2 security encryption.

## STATUS

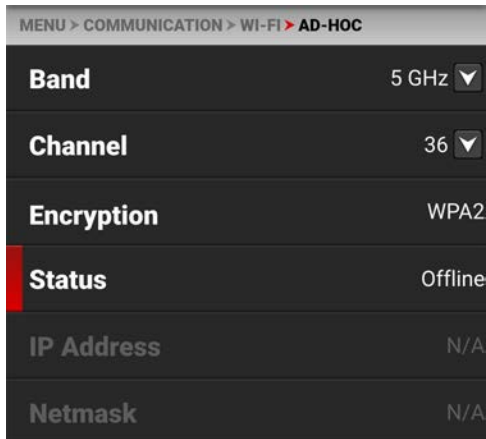

MENU > COMMUNICATION > WI-FI > AD-HOC	
Band	5 GHz ▼
Channel	36 ▼
Encryption	WPA2
Status	Offline
IP Address	N/A
Netmask	N/A

Displays the camera's Ad-Hoc Wi-Fi connection status.

The Ad-Hoc status can include:

- Offline
- Online

## IP ADDRESS

When online and broadcasting a network, the camera displays an IP address.

## NETMASK

When online and broadcasting a network, the camera displays the Netmask for the IP address.

## INFRASTRUCTURE

Use Infrastructure to configure the camera to connect to an existing Wi-Fi network.

**NOTE:** The Infrastructure menu is enabled when the Wi-Fi Mode is set to **Infrastructure**. Refer to the **Wi-Fi** section for more information.

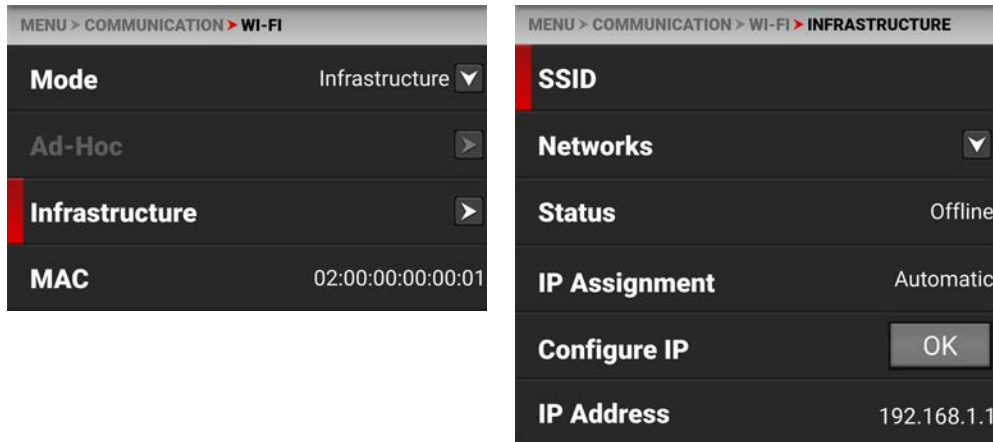

Use the Infrastructure menu to configure the Wi-Fi settings to connect to an existing Wi-Fi infrastructure:

ITEMS	DETAILS
SSID	Displays the name of the connected Wi-Fi network
Networks	Scan for, select, or enter the Wi-Fi network
Status	Displays the Wi-Fi connection status
IP Assignment Status	Displays the IP Assignment mode
Configure IP	Select the IP Assignment mode and add manual addresses
IP Address	View or enter the Wi-Fi IP address
Netmask	View or enter the Wi-Fi Netmask address
Gateway	View or enter the Wi-Fi Gateway (router) address

## SSID

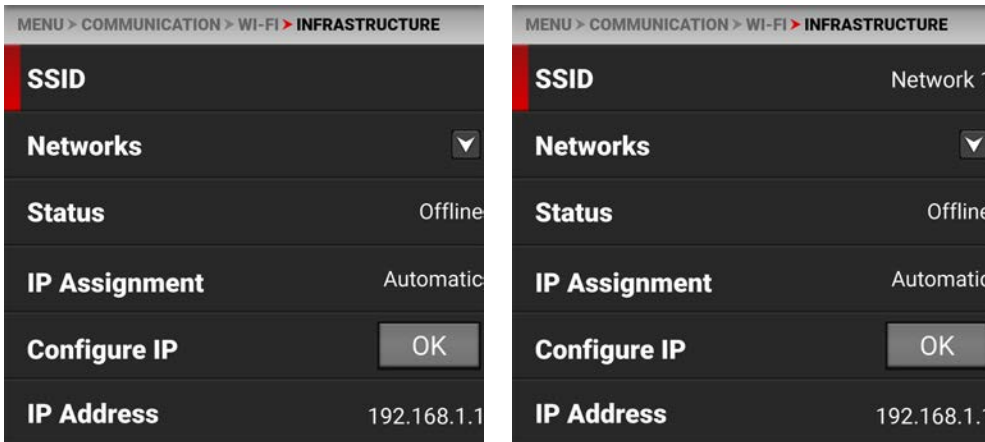

When a network is selected, the SSID displays the Wi-Fi network name (SSID).

## NETWORKS

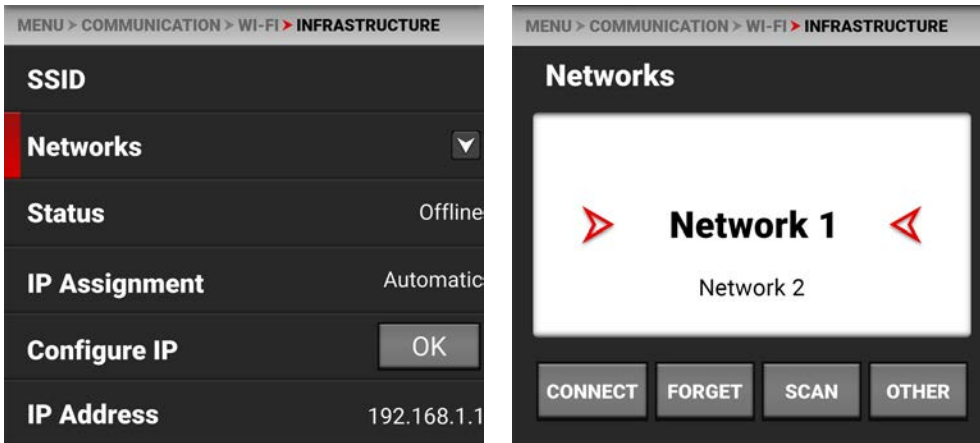

Use Networks to select an existing network, scan for an available network, or to configure a new network.

- **CONNECT:** The CONNECT button connects the camera to the selected network.
- **FORGET:** The FORGET button erases the connection information for the selected network.
- **SCAN:** The SCAN button searches for available networks.
- **OTHER:** The OTHER button opens the OTHER NETWORKS screen where you can manually enter an SSID and a Passphrase.

Tap SSID to open the SSID editing screen and enter the desired network SSID:



Tap Passphrase to open the Passphrase editing screen and enter the desired passphrase for the network:



Tap Connect to connect to the new network:

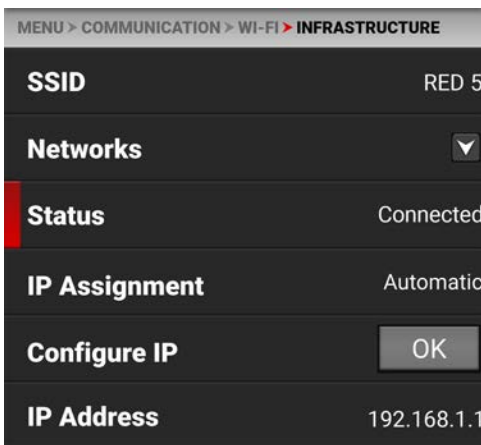

## STATUS

Displays the connection status of the camera to the selected Wi-Fi network.

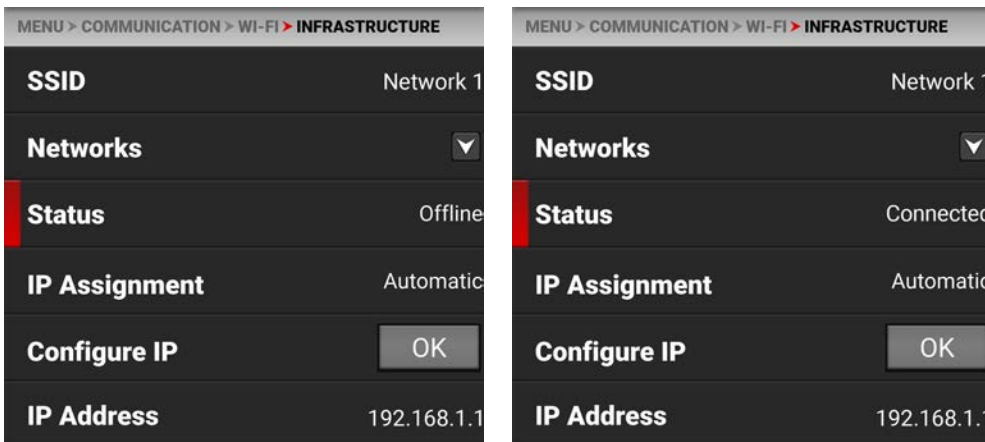

## IP ASSIGNMENT STATUS

IP Assignment displays the IP assignment mode. In Automatic mode, the camera automatically discovers the Infrastructure IP Address. In Manual mode, you can manually enter the network addresses in the camera.

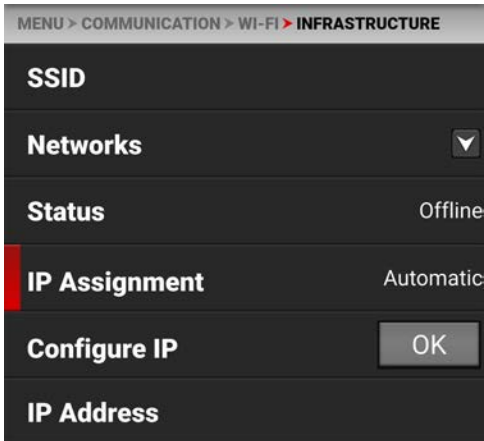

## CONFIGURE IP

Tap OK to Open the Infrastructure Configure IP screen.



You use the Configure IP screen to select the IP Assignment mode, and to manually enter the IP, Netmask, and Gateway addresses in Manual mode.

## IP ASSIGNMENT SELECTION

IP Assignment allows you to select the Infrastructure IP Assignment mode.

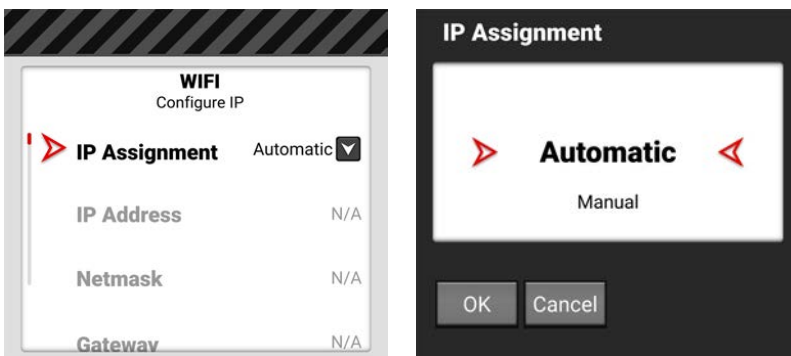

The Automatic mode detects the available Infrastructure IP address. The Manual mode allows you to manually enter the desired Infrastructure network addresses.

### MANUAL IP ADDRESS

IP Address allows you to manually enter the IP address when in Manual mode.

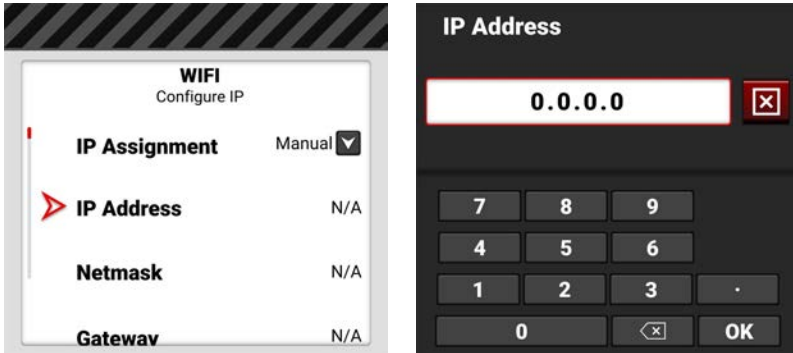

### MANUAL NETMASK ADDRESS

Netmask allows you to manually enter the Infrastructure Netmask address when in Manual mode.

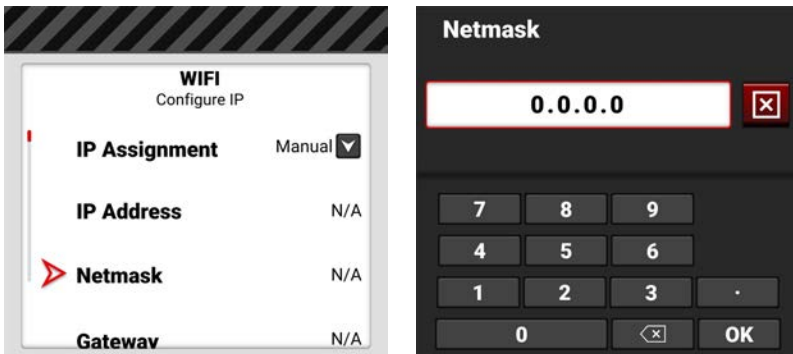

### MANUAL GATEWAY ADDRESS

Gateway allows you to manually enter the Infrastructure Gateway (router) address when in Manual mode.

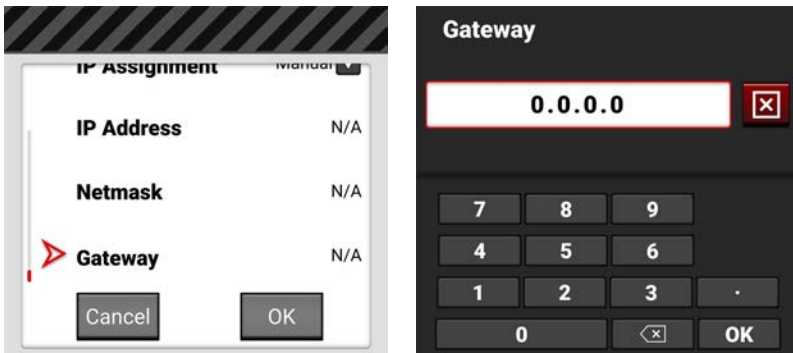



## IP ADDRESS

Displays the Infrastructure IP address.

MENU > COMMUNICATION > WI-FI > INFRASTRUCTURE	
Status	Connected
IP Assignment	Automatic
Configure IP	<input type="button" value="OK"/>
<b>IP Address</b>	192.168.1.1
Netmask	255.255.255.0
Gateway	192.168.1.2

## NETMASK

Displays the Infrastructure Netmask address.

MENU > COMMUNICATION > WI-FI > INFRASTRUCTURE	
Status	Connected
IP Assignment	Automatic
Configure IP	<input type="button" value="OK"/>
IP Address	192.168.1.1
<b>Netmask</b>	255.255.255.0
Gateway	192.168.1.2

## GATEWAY

Displays the Infrastructure Gateway address.

MENU > COMMUNICATION > WI-FI > INFRASTRUCTURE	
Status	Connected
IP Assignment	Automatic
Configure IP	<input type="button" value="OK"/>
IP Address	192.168.1.1
Netmask	255.255.255.0
<b>Gateway</b>	192.168.1.2

## SERIAL

Use Serial to configure the serial connection to the **Extension Port**.

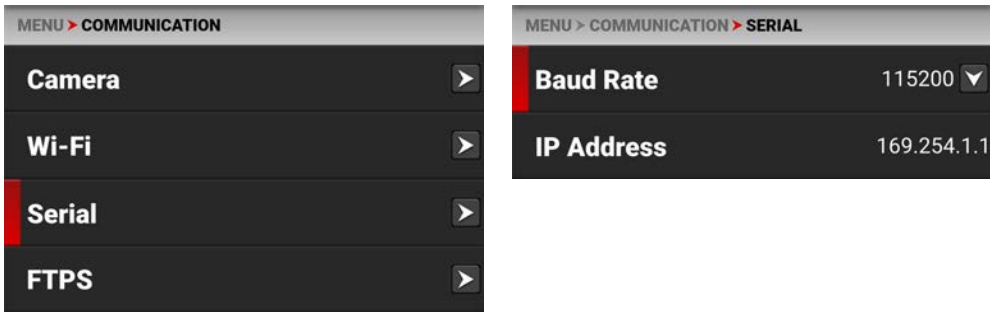

The settings you can configure for the serial connection through the Extension Port include:

ITEMS	DETAILS
<b>Baud Rate</b>	Select the serial port baud rate
<b>IP Address</b>	Enter the IP address for the PPP protocol

## BAUD RATE

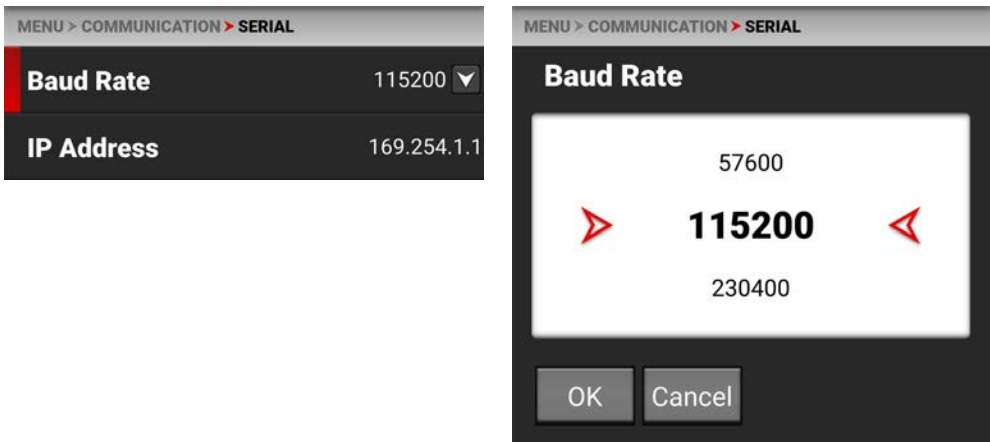

The Baud rate controls how fast data is transmitted over the serial connection. The higher the speed, the more likely that errors can occur. The Baud rates you can choose include:

## BAUD RATES

9600	115200*	576000	1500000
19200	230400	921600	2000000
38400	460800	1000000	2500000
57600	500000	1152000	3000000

\* Default

## IP ADDRESS

MENU > COMMUNICATION > SERIAL

**Baud Rate** 115200 ▼

**IP Address** 169.254.1.1

MENU > COMMUNICATION > SERIAL

**IP Address**

7 8 9

4 5 6

1 2 3 .

0 < x OK

Use the keypad to enter the internet provider's IP address.

## KOMODO LINK ADAPTOR

Use the KOMODO Link Adaptor menu to view the IP address of the connected Ethernet, Android or iOS device. This menu item only displays when the **KOMODO Link Adaptor** is attached to the camera.

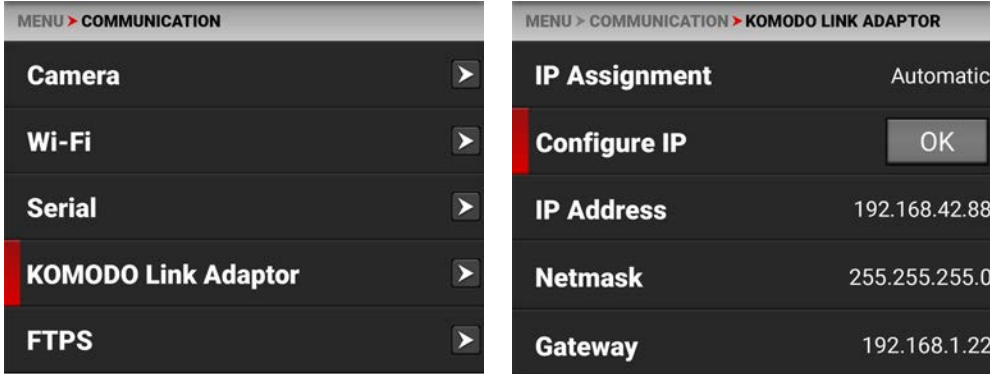

The settings you can configure for the KOMODO Link Adaptor include:

ITEM	DETAILS
IP Assignment	Displays the IP address assignment method
Configure IP	IP Address modes and configuration settings
IP Address	View or enter the network IP address
Netmask	View or enter the network Netmask
Gateway	View or enter the network Gateway

## CONFIGURE IP

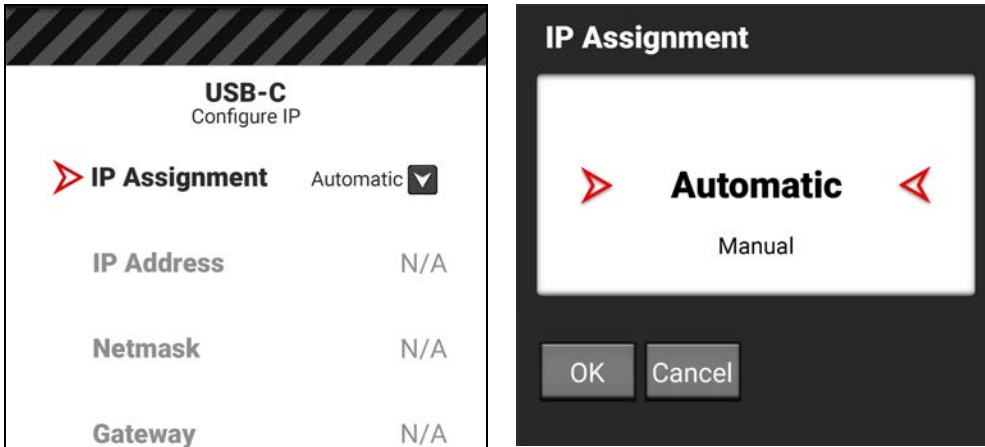

When connected to an Ethernet network, this allows you to automatically detect an IP address or to manually enter an IP address, Netmask address, and Gateway (router) address.

## IP ADDRESS

When the link is connected to an Ethernet device and Automatic IP Assignment is enabled, IP Address displays the network IP address.

MENU > COMMUNICATION > KOMODO LINK ADAPTOR

<b>IP Assignment</b>	Automatic
<b>Configure IP</b>	<input type="button" value="OK"/>
<b>IP Address</b>	192.168.42.88
<b>Netmask</b>	255.255.255.0
<b>Gateway</b>	192.168.1.22

When Manual IP Assignment is enabled, you can select IP Address and manually enter a static IP address.

USB-C  
Configure IP

<b>IP Assignment</b>	Manual <input type="checkbox"/>
<b>IP Address</b>	N/A
<b>Netmask</b>	N/A
<b>Gateway</b>	N/A

MENU > COMMUNICATION > KOMODO LINK ADAPTOR

**IP Address**

7	8	9	
4	5	6	
1	2	3	.
0	<input type="button" value="X"/>	<input type="button" value="OK"/>	

## NETMASK

When the link is connected to an Ethernet device and Automatic IP Assignment is enabled, Netmask displays the network Netmask address.

MENU > COMMUNICATION > KOMODO LINK ADAPTOR

<b>IP Assignment</b>	Automatic
<b>Configure IP</b>	<input type="button" value="OK"/>
<b>IP Address</b>	192.168.42.88
<b>Netmask</b>	255.255.255.0
<b>Gateway</b>	192.168.1.22

When Manual IP Assignment is enabled, you can select Netmask and manually enter a Netmask address.

USB-C  
Configure IP

<b>IP Assignment</b>	Manual <input type="checkbox"/>
<b>IP Address</b>	N/A
<b>Netmask</b>	N/A
<b>Gateway</b>	N/A

MENU > COMMUNICATION > KOMODO LINK ADAPTOR

**Netmask**

7	8	9	
4	5	6	
1	2	3	.
0	<input type="button" value="X"/>	<input type="button" value="OK"/>	

## GATEWAY

When the link is connected to an Ethernet device and Automatic IP Assignment is enabled, Gateway displays the network Gateway address (router address).

MENU > COMMUNICATION > KOMODO LINK ADAPTOR	
IP Assignment	Automatic
Configure IP	OK
IP Address	192.168.42.88
Netmask	255.255.255.0
<b>Gateway</b>	192.168.1.22

When Manual IP Assignment is enabled, you can select Gateway and manually enter a Gateway (router) address.

MENU > COMMUNICATION > KOMODO LINK ADAPTOR	
<b>USB-C</b> Configure IP	
IP Assignment	Manual <input type="checkbox"/>
IP Address	N/A
Netmask	N/A
<b>Gateway</b>	N/A

  

MENU > COMMUNICATION > KOMODO LINK ADAPTOR																	
<b>Gateway</b>																	
0.0.0.0	<input type="button" value="X"/>																
<table border="0" style="width: 100%;"> <tr> <td style="border: 1px solid gray; padding: 5px;">7</td> <td style="border: 1px solid gray; padding: 5px;">8</td> <td style="border: 1px solid gray; padding: 5px;">9</td> <td></td> </tr> <tr> <td style="border: 1px solid gray; padding: 5px;">4</td> <td style="border: 1px solid gray; padding: 5px;">5</td> <td style="border: 1px solid gray; padding: 5px;">6</td> <td></td> </tr> <tr> <td style="border: 1px solid gray; padding: 5px;">1</td> <td style="border: 1px solid gray; padding: 5px;">2</td> <td style="border: 1px solid gray; padding: 5px;">3</td> <td style="border: 1px solid gray; padding: 5px;">.</td> </tr> <tr> <td style="border: 1px solid gray; padding: 5px;">0</td> <td style="border: 1px solid gray; padding: 5px;"><input type="button" value="X"/></td> <td colspan="2" style="border: 1px solid gray; padding: 5px; text-align: right;"><input type="button" value="OK"/></td> </tr> </table>		7	8	9		4	5	6		1	2	3	.	0	<input type="button" value="X"/>	<input type="button" value="OK"/>	
7	8	9															
4	5	6															
1	2	3	.														
0	<input type="button" value="X"/>	<input type="button" value="OK"/>															

For more information, refer to the How To section ([KOMODO Link Adaptor](#)).

## FTPS

Use FTPS to configure the camera to work with a File Transfer Protocol Secure (FTPS) connection.

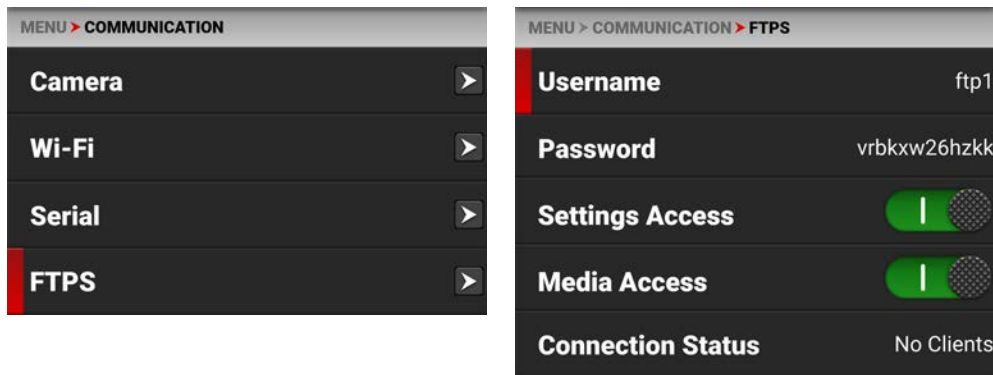

Use the FTPS menu to configure the camera's FTPS settings:

ITEMS	DETAILS
Username	Static username ftp1
Password	User-editable password
Settings Access	Enable FTP access to the camera settings
Media Access	Enable read-only access to the media
Connection Status	Displays the FTPS actions occurring

## PASSWORD

Use Password to enter an FTPS password. When you tap on the password, the Password editing screen appears.

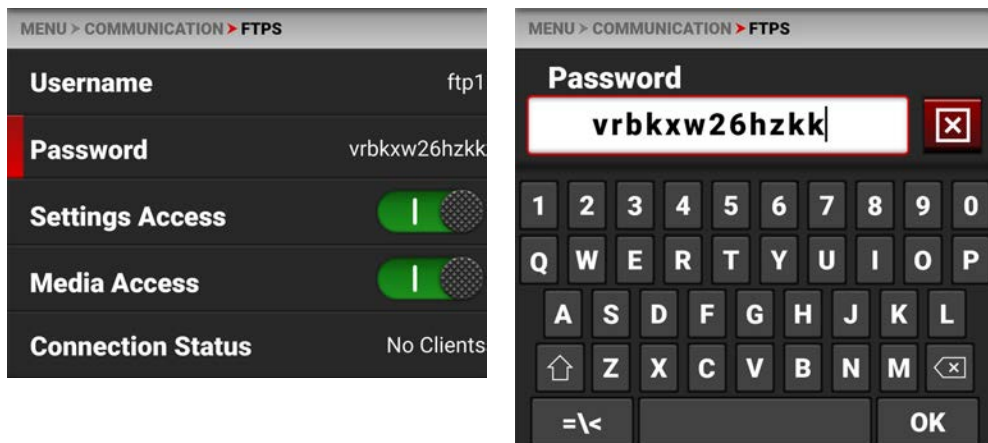

The password must contain a minimum of 8 characters.



## SYSTEM SETTINGS MENU

The System Settings menu contains the camera system configuration settings.

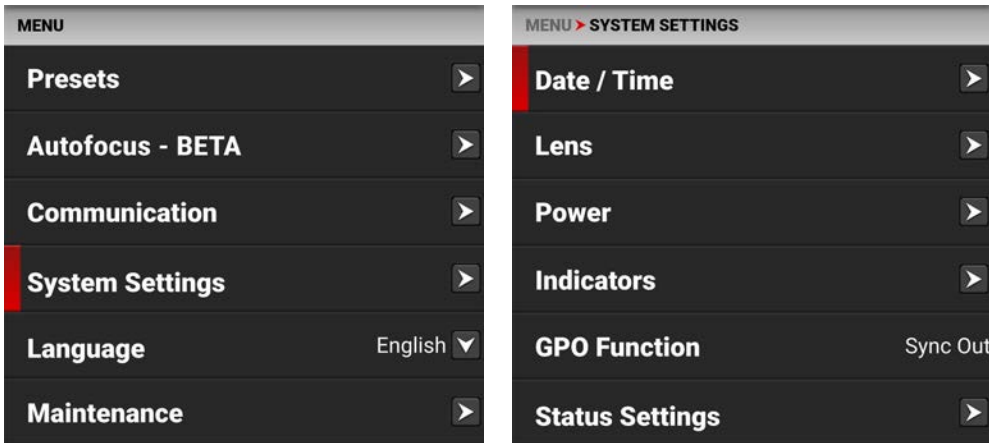

Use the System Settings menu to configure the camera system settings:

ITEMS	DETAILS
Date / Time	Date and time settings
Lens	View lens status information and access the Aperture menu
Power	DC and battery status
Indicators	Enable or disable the record sounds and the front Tally LED
GPO Function	Displays Sync Out function
Status Settings	Shutter mode, aperture increments, and focus length units settings
System Status	Information about the camera's type, PIN, FW, and runtime

## DATE / TIME

Use the Date / Time menu to reset the internal clock of the camera. The time and date are timestamped on R3D® files when recording to the media. The camera uses the 24-hour clock convention (military time). For example, enter 2:35 p.m. as 14:35:00.

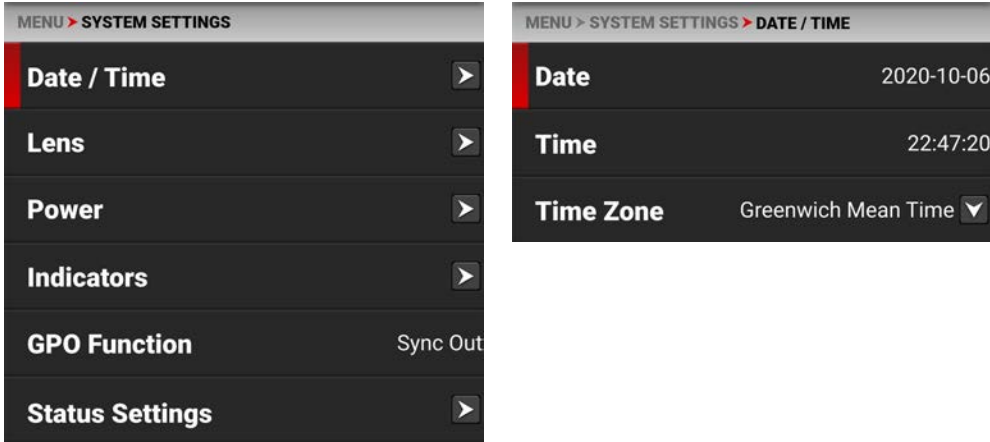

The Date / Time menu items include:

ITEMS	DETAILS
Date	Date in YYYY-MM-DD format
Time	24-hour format
Time Zone	Global time zones

## DATE

Use Date to enter the date using the touchscreen keypad:

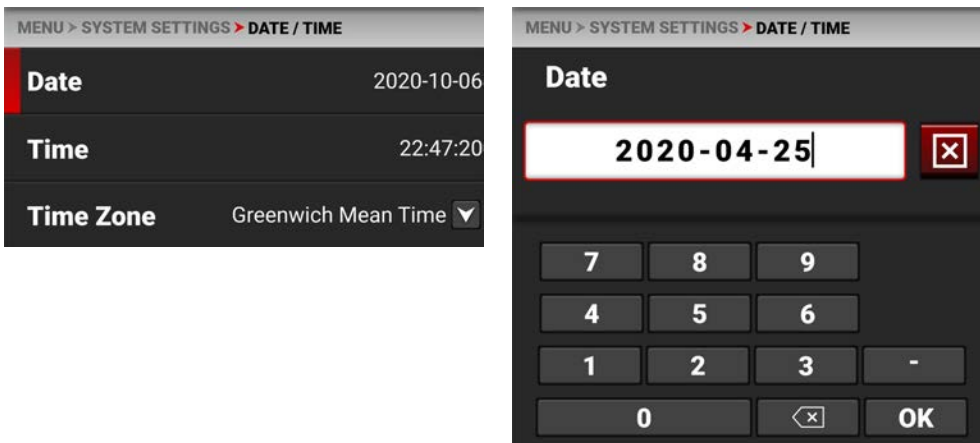

## TIME

Use Time to enter the time in 24-hour military format using the touchscreen keypad:

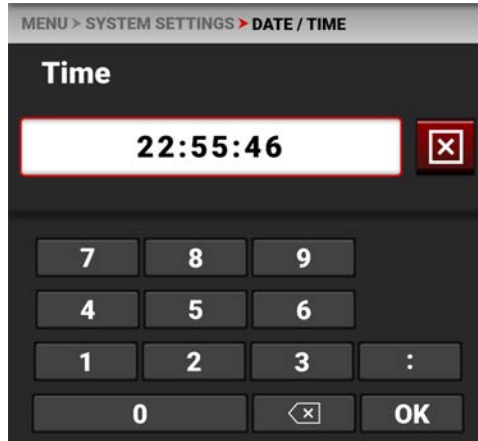
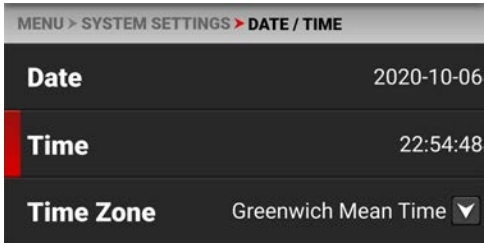

## TIME ZONE

Use Time Zone to select the local time zone for where the camera is located.

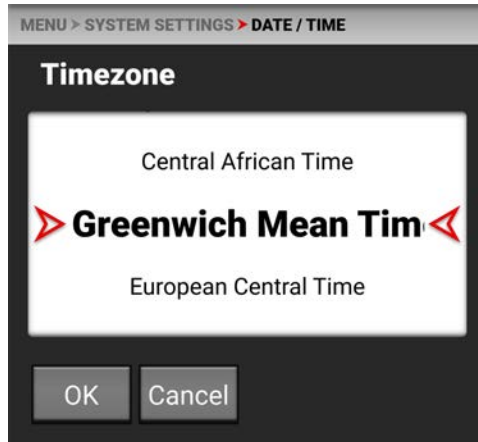
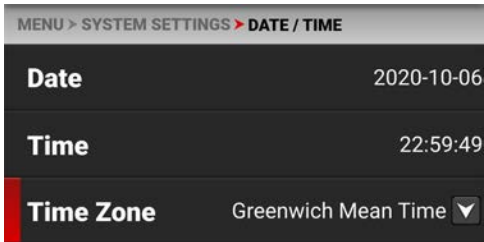

## LENS

Use Lens to view information about the attached lens.

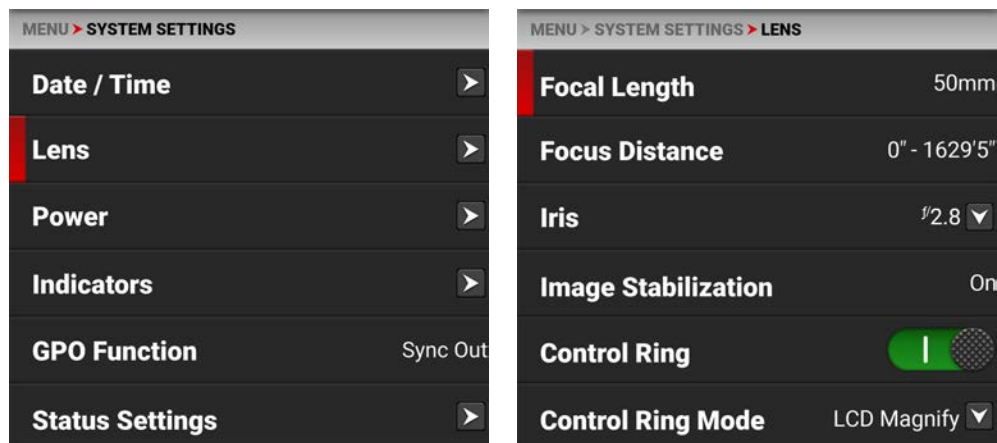

The information you can view from Lens includes:

ITEMS	DETAILS
Focal Length	Displays the lens focal length value
Focus Distance	Displays the lens focal distance value
Iris	Lens Iris menu
Image Stabilization	Displays the lens image stabilization status
Control Ring	Enables the lens control ring
Control Ring Mode	Control Ring Mode settings

## IRIS

Use the Iris menu to select the camera lens f-stop. Tap Edit to open the keypad and enter the f-stop manually.

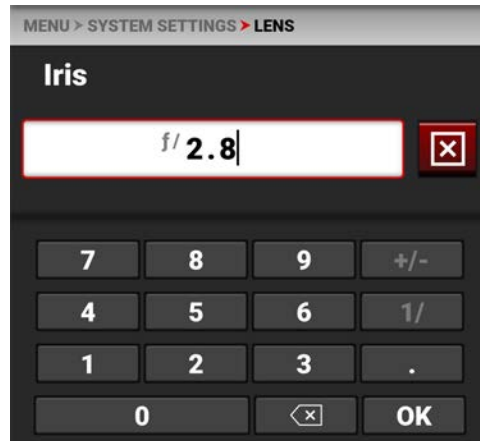
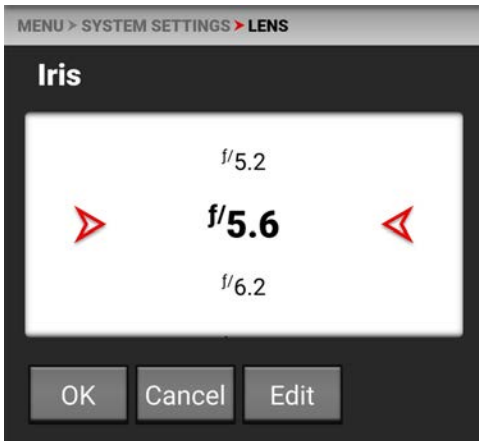

## CONTROL RING MODE

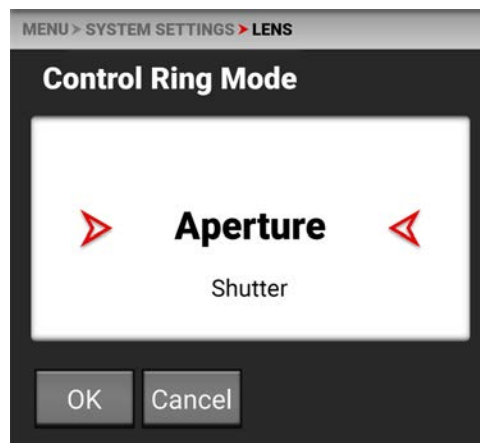

Use Control Ring Mode to select the camera setting you want the Control Ring to adjust.

The modes you can select include Aperture (*Iris*, default), *Shutter*, *ISO*, *White Balance*, LCD Magnify, SDI Magnify, LCD + SDI Magnify, False Color Cycle, Peaking Cycle, and Tools Cycle.

## POWER

Use the Power menu to view the various camera power status indicators:

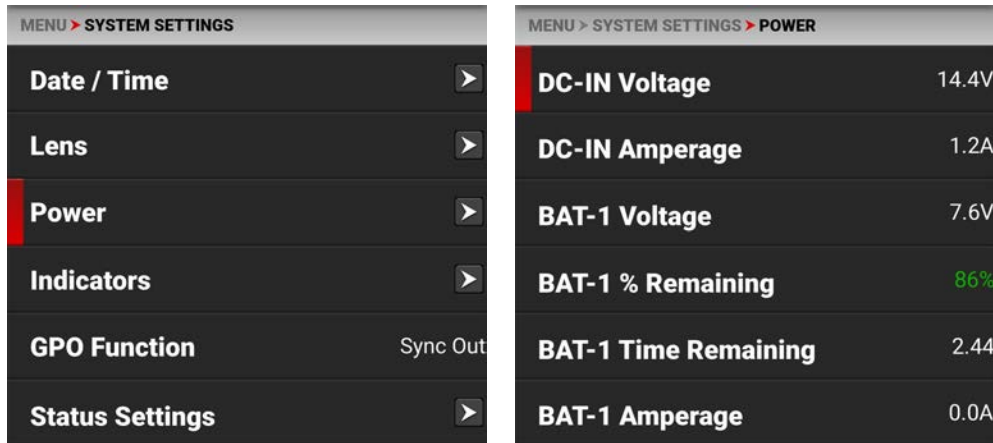

The Power indicators you can view include:

ITEMS	DETAILS
DC-IN Voltage	When DC is connected, this displays the DC Voltage
DC-IN Amperage	When DC is connected, this displays the DC Amps
BAT-1 Voltage	When a battery is connected in the left #1 slot, this displays the battery Voltage
BAT-1 % Remaining	When a compatible battery is connected in the left #1 slot, this displays the % of battery charge remaining
BAT-1 Time Remaining	When a battery is connected in the left #1 slot, this displays the camera operating time remaining
BAT-1 Amperage	When a battery is connected in the left #1 slot, this displays the battery Amps
BAT-2 Voltage	When a battery is connected in the right #2 slot, this displays the battery Voltage
BAT-2 % Remaining	When a compatible battery is connected in the right #2 slot, this displays the % of battery charge remaining
BAT-2 Time Remaining	When a battery is connected in the right #2 slot, this displays the camera operating time remaining
BAT-2 Amperage	When a battery is connected in the right #2 slot, this displays the battery Amps
Power Out	Enables or disables the 5 V / 500 mA power out of the <b>Extension Port</b>

## INDICATORS

Use the Indicators menu to enable or disable sound and the tally light (refer to the [Camera Body](#) section for more information about the camera LEDs), and to select the record start indicator and record stop indicator sounds.

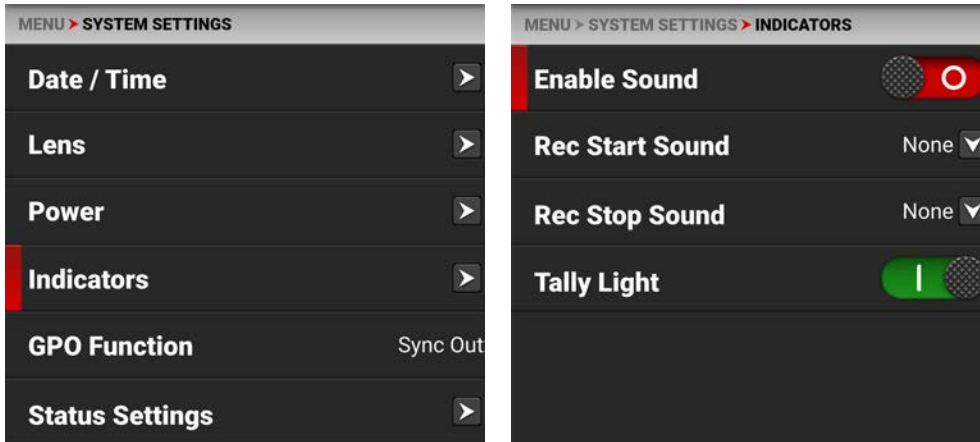

### ENABLE SOUND

Use Enable Sound to allow the selected sounds to play.



### REC START SOUND

Rec Start Sound allows you to select the sound to play when you begin a recording.

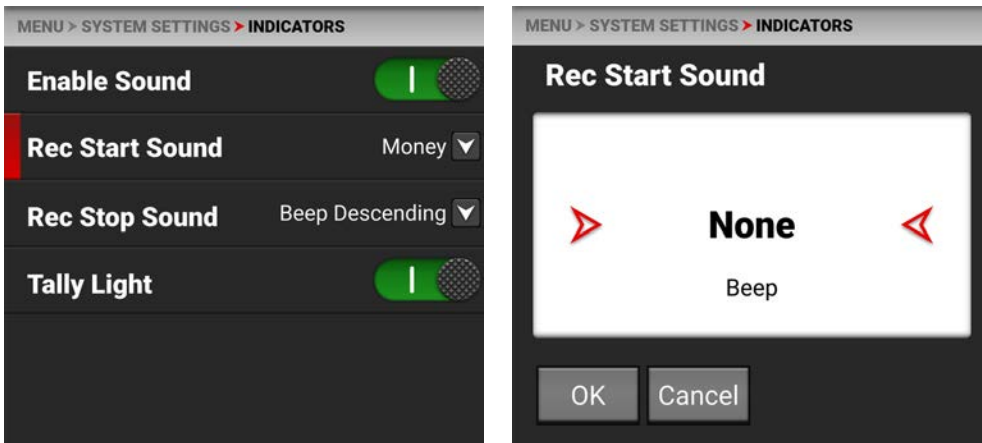

The sounds you can select include:

- None
- Beep
- Double Beep
- Beep Ascending
- Beep Descending
- Money
- Shutter

### REC STOP SOUND

Rec Stop Sound allows you to select the sound to play when you end a recording.

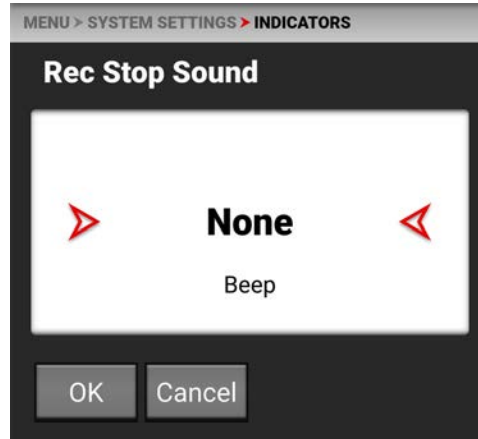
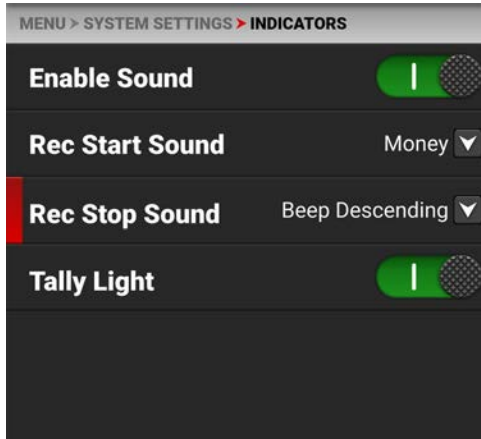

The sounds you can select include:

- None
- Beep
- Double Beep
- Beep Ascending
- Beep Descending
- Money
- Shutter

## TALLY LIGHT

Use Tally Light to enable or disable the front recording tally LED.



For more information, refer to the [Camera Body LED](#) section.



## GPO FUNCTION

Use the GPO Function menu to select the GPO function of the Extension port.

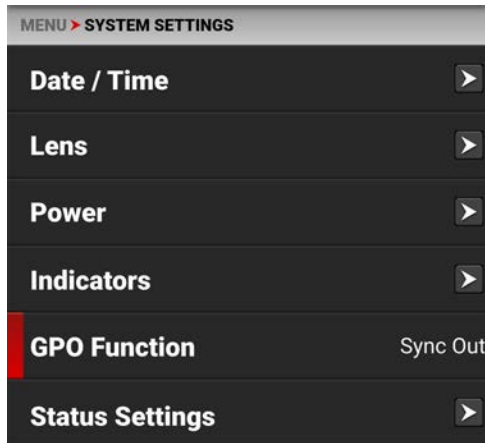

Currently, the GPO function supports Sync Out for the Extension port.

## SYNC OUT

The Sync Out function sends a Sync signal out of the Extension port GPO pin.

For more information, refer to [Extension Port](#).

## STATUS SETTINGS

Use the Status Settings menu to select the shutter display mode, aperture increment, and focus distance units displayed in the camera's menus.

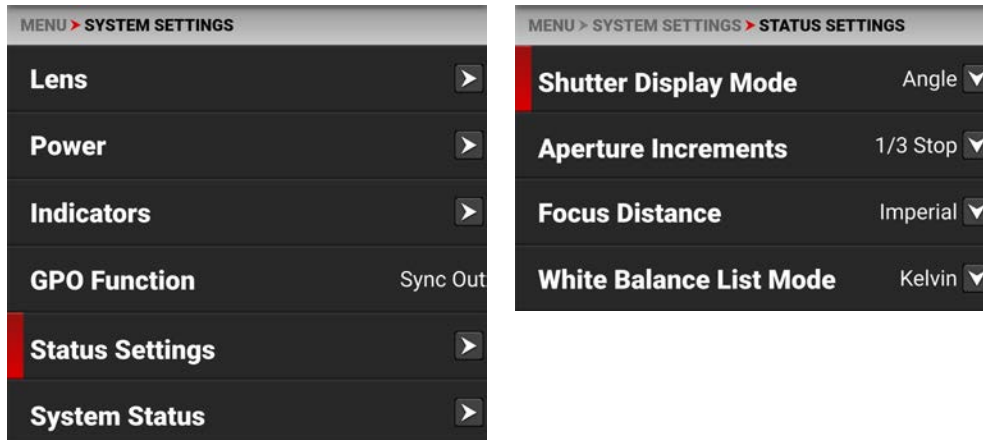

The Status Settings that you can configure include:

ITEMS	DETAILS
<a href="#">Shutter Display Mode</a>	Select a time-fraction or an angle for the shutter menu display unit
<a href="#">Aperture Increments</a>	Select 1/4 or 1/3 f-stop increments
<a href="#">Focus Distance</a>	Select the focus distance units (Metric or Imperial)
<a href="#">White Balance List Mode</a>	Select Kelvin or White Balance Presets

## SHUTTER DISPLAY MODE

Use Shutter Display mode to select the way that the camera displays the **Shutter** setting in the menu.

When select Angle, the **Shutter** menu displays the choices in degrees. When you select Time, the Shutter menu displays the choices in fractions of a second.

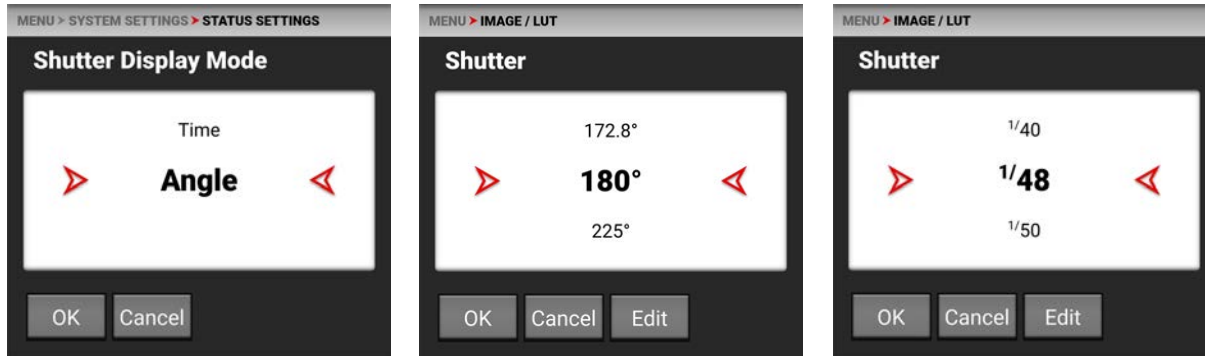

## APERTURE INCREMENTS

Use Aperture Increments to select one fourth increments or one third increments for the camera f-stop settings. The default is 1/3 Stop.

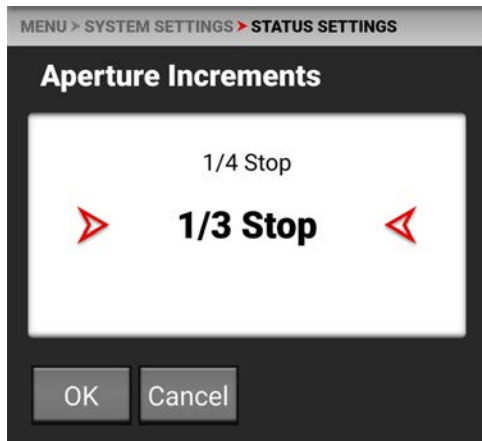

## FOCUS DISTANCE

Use Focus Distance to select Imperial or Metric units for the **Lens** Focus Distance display. The default is Imperial.

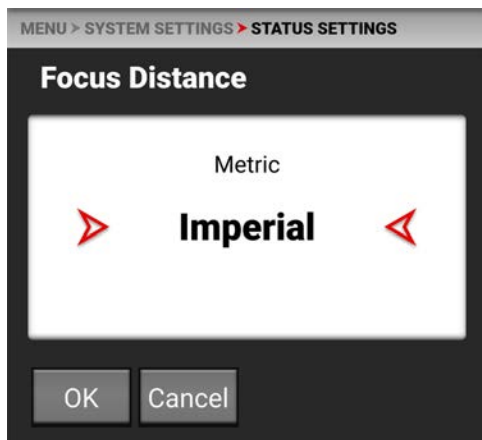

## WHITE BALANCE LIST MODE

Use White Balance List Mode to select Kelvin or Presets for the White Balance Color Temperature menu. The default is Kelvin.

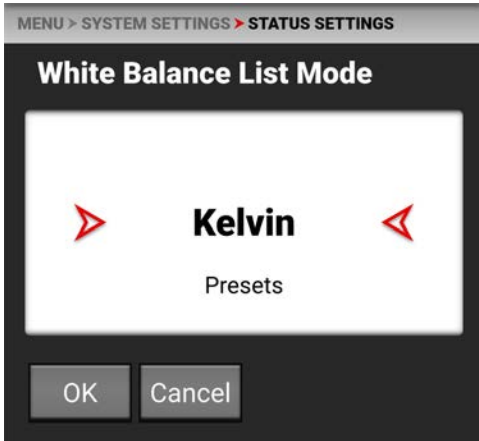

## SYSTEM STATUS

Use the System Status menu to view camera information and to view temperature readings.

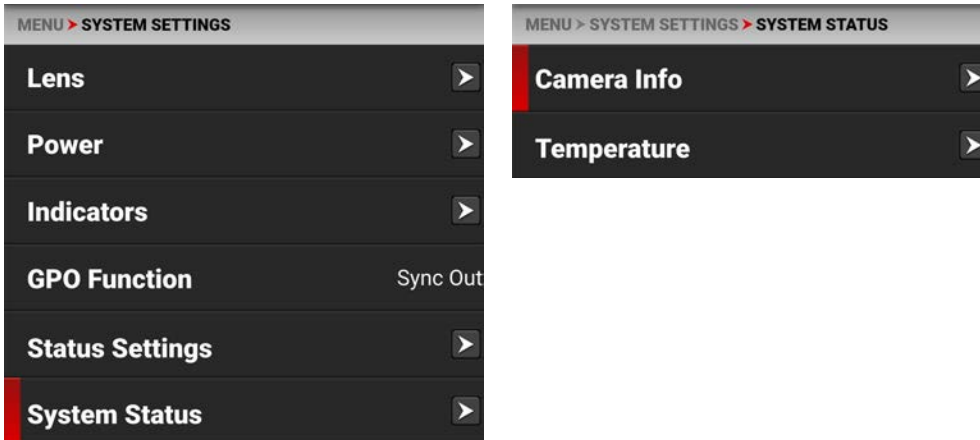

The system status information you can view includes:

ITEMS	DETAILS
Camera Info	Camera information
Temperature	Camera temperatures

## CAMERA INFO

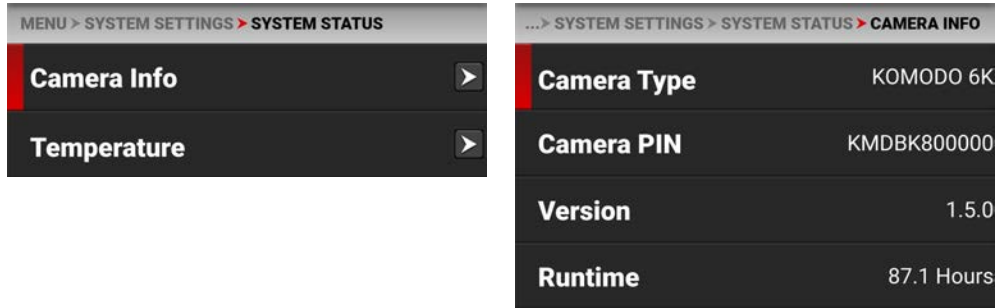

The camera information you can view includes:

ITEMS	DETAILS
Camera Type	Displays the camera description
Camera PIN	Displays the camera personal identification number (PIN)
Version	Displays the firmware version number installed on the camera
Runtime	Displays the total number of hours that the camera has run

## TEMPERATURE

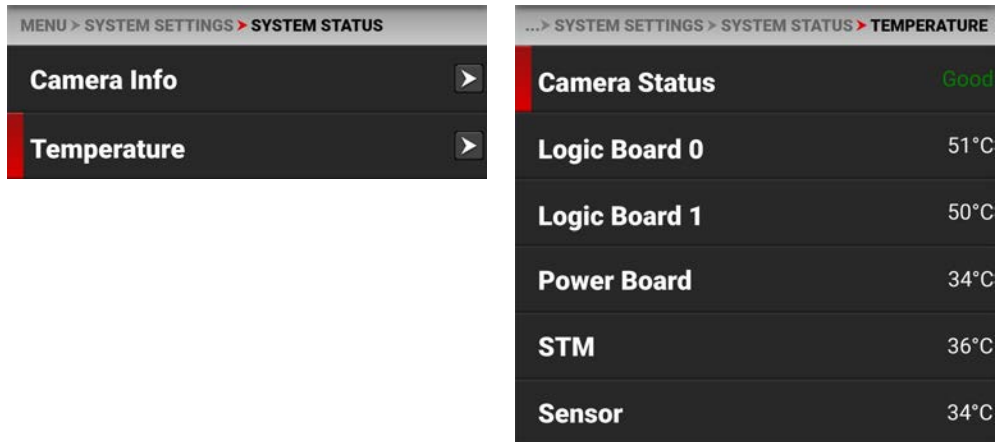

The camera temperatures you can view include:

ITEMS	DETAILS
Camera Status	Displays Good (green) or Overheating (yellow)
Logic Board 0	Displays the Celsius temperature of Logic Board 0
Logic Board 1	Displays the Celsius temperature of Logic Board 1
Power Board	Displays the Celsius temperature of the power IC board
STM	Displays the Celsius temperature of the power STM IC
Sensor	Displays the Celsius temperature of the sensor

## LANGUAGE MENU

The Language menu contains the languages you can select for the user interface (UI).

From the camera LCD touchscreen menu, tap Language:

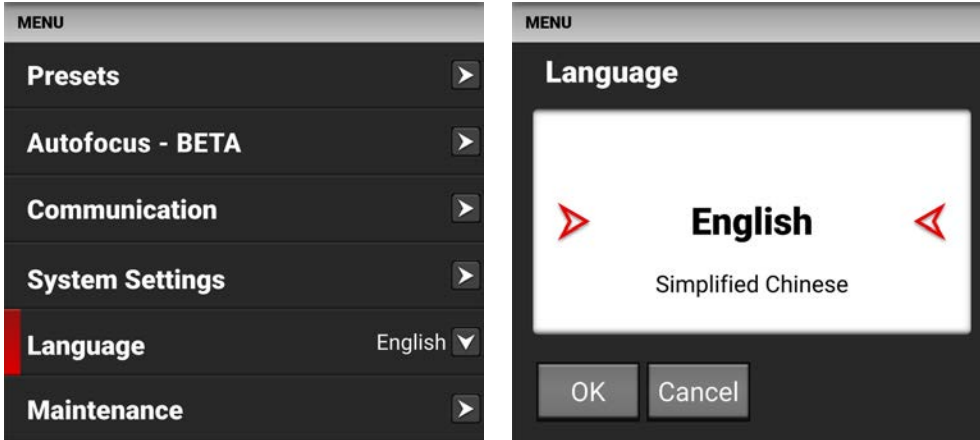

The languages you can select include:

- English
- Simplified Chinese
- French
- German
- Japanese
- Spanish

## MAINTENANCE MENU

The Maintenance menu contains the settings you use to perform various maintenance tasks on your camera.

From the camera LCD touchscreen menu, select Maintenance:

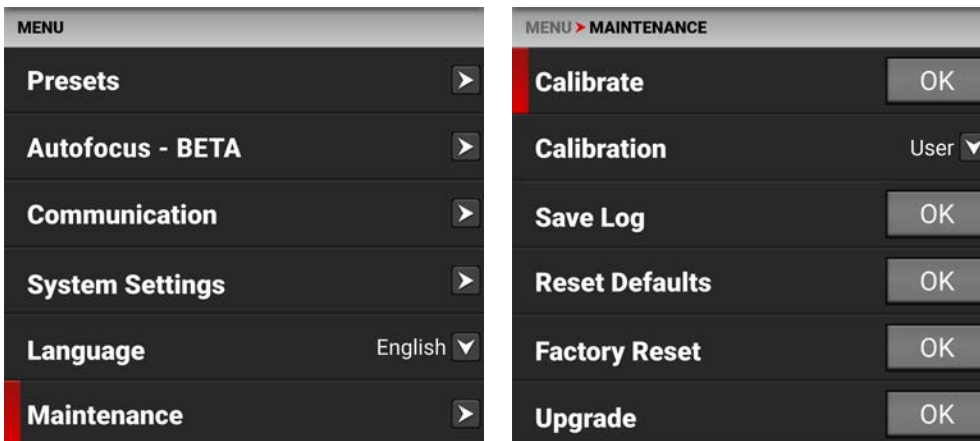

Use the Maintenance menu to perform the following camera maintenance tasks:

ITEM	DETAILS
Calibrate	Performs the selected Calibration
Calibration	List of calibration options
Save Log	Saves the camera log files to the media
Reset Defaults	Resets the camera settings to their default settings
Factory Reset	Restores the camera to the factory settings
Upgrade	Updates the firmware

## CALIBRATE

Use Calibrate to start the camera calibration process and create your User calibration profile.

Only calibrate the camera after it has reached its operational temperature. This occurs usually within ten minutes after you turn on the camera in the filming environment. Do not calibrate immediately after powering on.

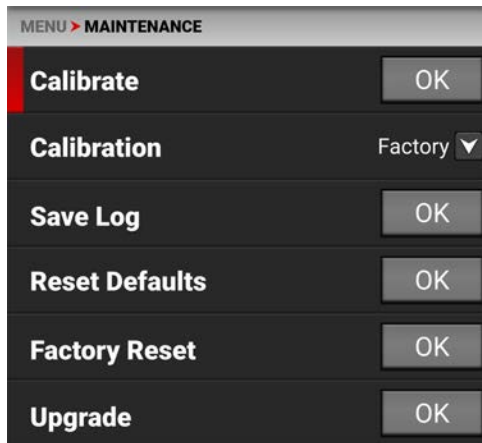

**NOTE:** Make sure that the mount cap is installed on the camera before you calibrate the camera.

Tap OK on the touchscreen to begin calibrating the camera.

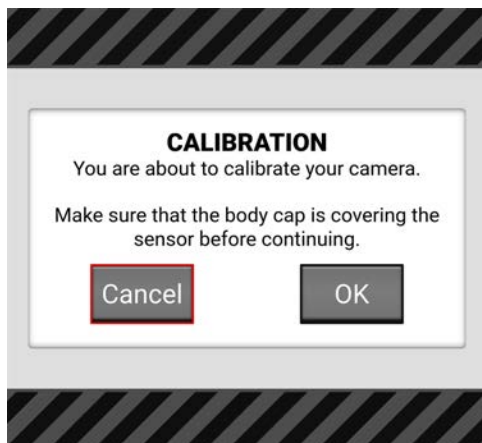

When the camera is finished calibrating, the touchscreen displays the Calibration status message:



or:

## CALIBRATION

Use Calibration to select the active camera Calibration.

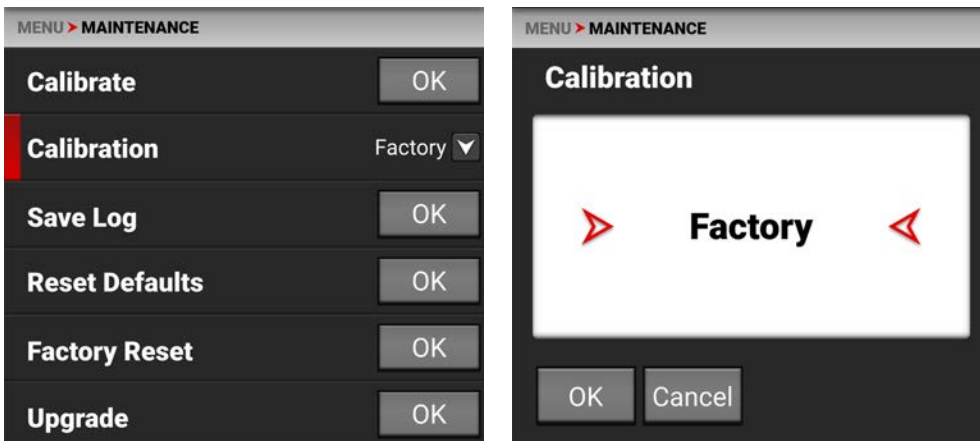

You should always select User calibration. The first time you calibrate the camera, the only choice is Factory. After you perform a calibration, the User calibration profile is added to the list and the camera makes it the default calibration. Every time you calibrate the camera, the User profile is updated. The only time the User profile is removed, is when you perform a Factory Reset.

If User calibration is not available, the camera defaults to Factory calibration. Calibrate the camera to generate the new User calibration profile.

## SAVE LOG

Use Save Log to save the camera log to the media.

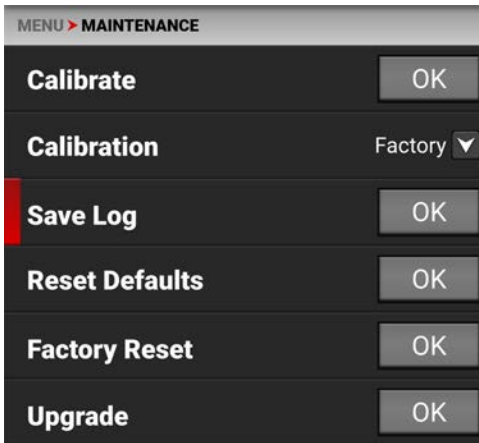

When the media is full, or missing, the camera will display an error message. When there is no error, the success message is displayed.

Error:

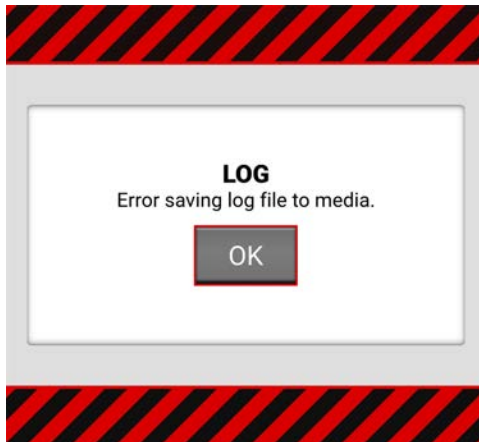

Success:

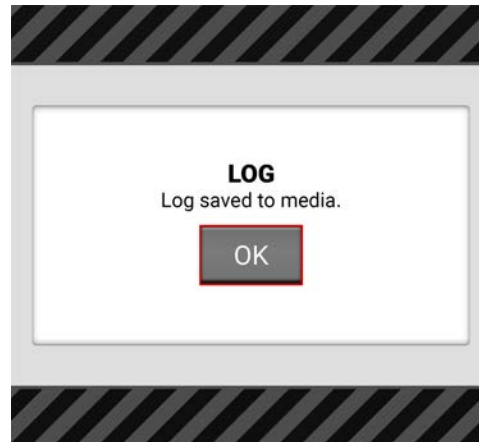

## RESET DEFAULTS

Use Reset Defaults to reset the camera to the factory default settings.

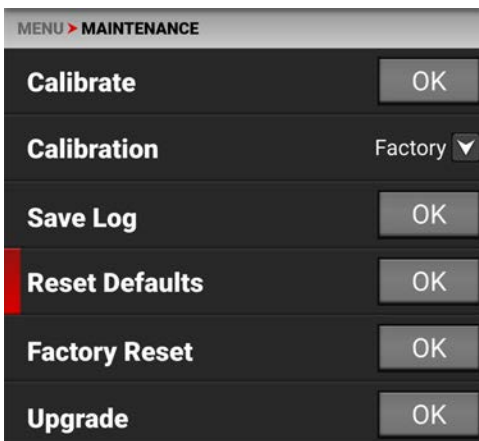

**NOTE:** Resetting the camera will delete all of your menu settings.



**NOTE:** The camera turns off, and then back on to complete the reset process.

Tap Yes on the touchscreen to reset the camera menus to the default settings.

## FACTORY RESET

Use Factory Reset to reset the camera to the factory settings.

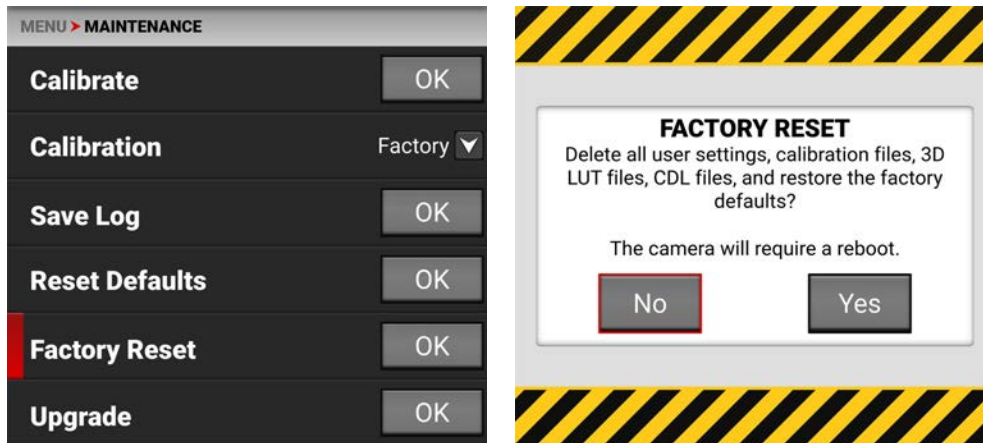

**NOTE:** Resetting the camera will delete all of your settings and remove all imported files. The camera turns off, and then back on to complete the reset process.

Tap Yes on the touchscreen to reset the camera to the factory settings.

## UPGRADE

Use Upgrade to perform a camera firmware update.

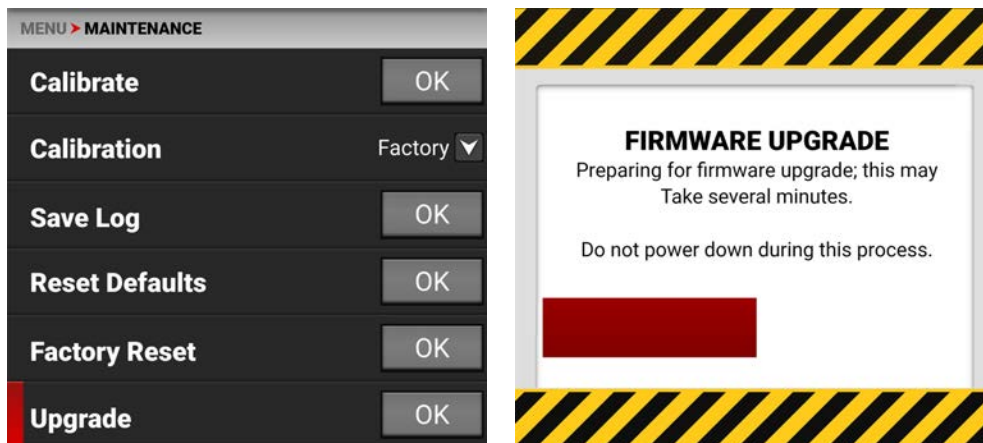

For more information about upgrading the firmware, refer to [Upgrading the Firmware](#).

## 5. HOW TO

This section describes how you can use the camera features.

### WI-FI CONFIGURATION

The camera offers a wireless (802.11g) connection that provides communication support for third-party applications. As with all wireless devices, the communication range varies with the environment and any radio frequency (RF) interference that may be present. You can select a wireless frequency of 2.4 GHz or 5 GHz. For optimal performance, do not obstruct the antenna with any accessory, mounting plate, or mounting rail.

The camera uses **Ad-Hoc** mode to set up the camera as a Wi-Fi hot spot.

The camera uses **Infrastructure** mode to connect to existing Wi-Fi infrastructure.

### CONNECTING WIRELESSLY TO AN EXISTING WI-FI NETWORK

This camera uses the WPA2 Wi-Fi protocol.

1. Navigate to the Wi-Fi menu **MENU > COMMUNICATION > Wi-Fi**.

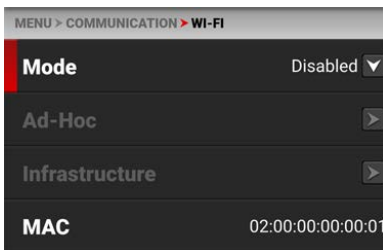

2. From the Mode option, select Infrastructure.



3. From the Infrastructure menu, select Networks:

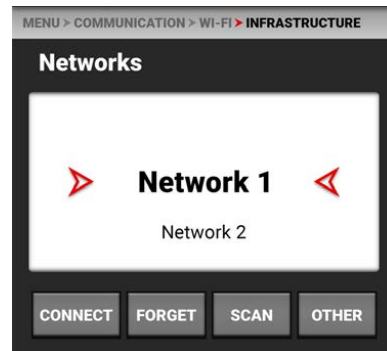
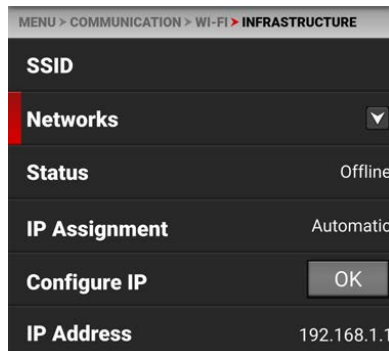

4. Select the network name from the Networks list menu:

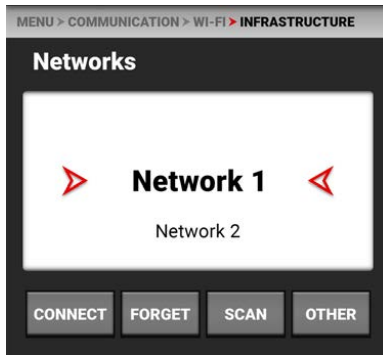

or tap SCAN to scan for available networks and update the Networks list:

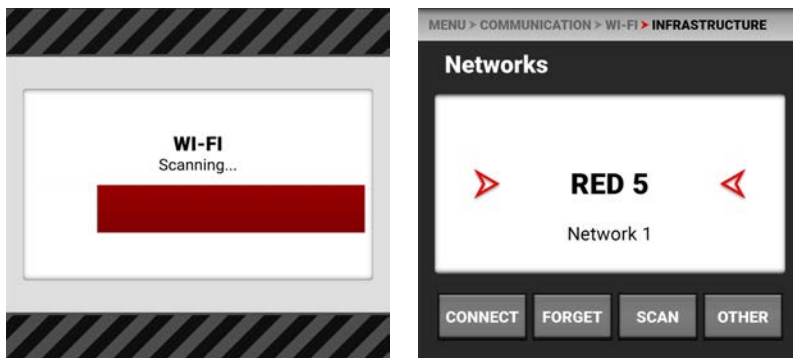

5. Tap CONNECT. The CONNECT screen displays:



6. Tap Passphrase. The Passphrase entry screen displays:

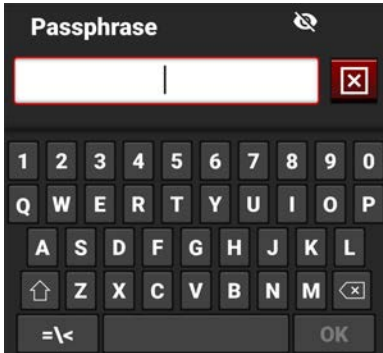

7. Enter the passphrase for the selected network. The passphrase must use a minimum of 8 characters.

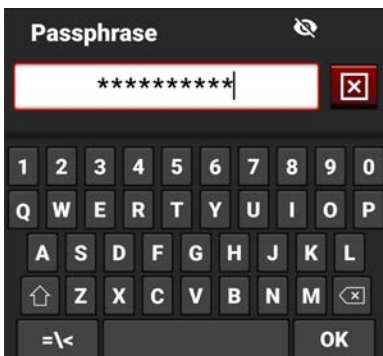

8. Tap OK on the completed Passphrase entry screen. The completed CONNECT screen displays.



9. Tap the Connect button. The camera connects to the selected network:

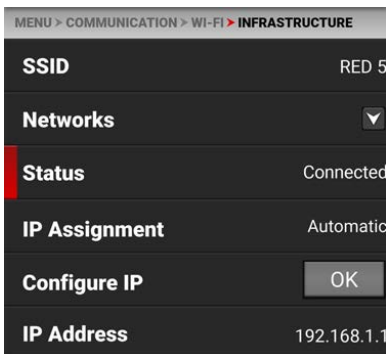

## POWER

### ATTACHING THE BATTERIES

Insert at least one compatible battery (refer to [Batteries](#)) in the left battery slot. Slide the battery until it clicks.



The camera can charge the batteries when they are attached to the camera and the DC power Adaptor is connected. The camera charges the batteries only when the camera is off and the power Adaptor is connected. While the batteries are charging the DC Power LED blinks amber until communication is established. The LED is solid amber when communication is established and the batteries are charging. The LED is green when communication is not established (incompatible battery) and the batteries are not charging.

**NOTE:** Incompatible batteries will not charge on the camera.

### REMOVING THE BATTERIES

You can hot swap a dead battery when you have another charged battery attached, and you can continue recording while you make the swap.

1. While holding the attached battery, press the **Eject Button**.
2. Slide and lift the battery out.

### POWER COMPONENTS

You can power the KOMODO camera with the RED [KOMODO Power Adaptor](#), an External DC Power Source, or with the rear-mounted [Batteries](#).

For information about charging, storing, or maintaining the batteries, refer to the manufacturer's instructions.

## KOMODO POWER ADAPTOR

The KOMODO 45-Watt AC power Adaptor connects to the camera's **DC-Input** port to provide DC power for operating the camera and for recharging the attached **Batteries**.



The camera charges the batteries when the camera is off and the power Adaptor is connected.

## AUTO BOOT ON POWER

The camera supports the Auto Boot on Power feature. This means that if all power sources are removed, and the Power Switch is set to ON, then when a power source is attached, the camera turns on.

## POWER CONSUMPTION

The camera draws various levels of power depending on the configuration and operating conditions. The power consumption guidelines are:

- The camera uses between 20 Watts and 24 Watts of power in its basic configuration
- Additional power may be necessary based on ambient temperature and changes to camera firmware in future updates (up to an additional 5 Watts)
- Up to an additional 8 Watts might be required for additional accessories attached to the top pogo port and the EXT port
- Maximum power consumption is not expected to exceed 37 Watts

## POWER PRIORITY

When multiple power sources are connected to the camera, power consumption is prioritized in this sequence:

1. Any power supply connected to the DC IN port.
2. Attached battery in the left slot (facing the back of the camera) then the battery attached in the right slot.

**WARNING:** Always attach the power or batteries before attaching the SDI BNC cable. Always remove the SDI BNC cable before removing the power or batteries.

## TURNING ON THE CAMERA

1. Attach a power source (**Batteries** or **DC-Input**) to the camera.
2. Slide the **Power Switch** up to the **ON** position.



## TURNING OFF THE CAMERA

**NOTE:** Do not turn off the camera while the camera is recording, or formatting media.

Slide the **Power Switch** down to the **OFF** position.



## MEDIA MANAGEMENT

This section explains how to use, record, format, and offload media for the camera.

**WARNING:** Do not attach a label to the CFast media card. The heat generated by the media can weaken the label's adhesive, causing the label to detach inside of the camera. Labels can also diminish heat dissipation and cause excessive wear to the internal components. Removing a label from a CFast media card can possibly deform the card body.

The camera supports exFAT as the file system for the media card to accommodate larger files and data rates. exFAT is supported both on macOS and MS Windows.

## EJECTING (UNMOUNTING) MEDIA

**IMPORTANT:** To ensure data integrity, media must always be ejected (unmounted) prior to removal from the camera. This ensures that power is removed from the media and any open data files are closed. Failure to properly eject (unmount) media may result in lost data or corrupted files.

To eject (unmount) media from the camera, use the **LCD Touchscreen** and select **Menu > Media**.

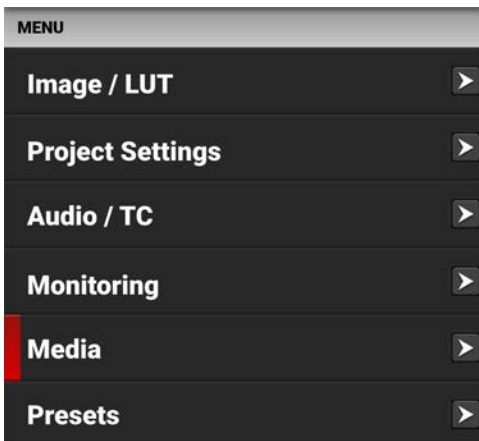



Tap the Eject OK button:

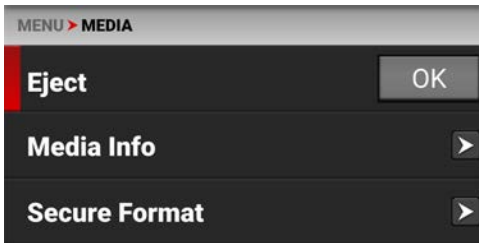

The Success message displays:



The media is now ejected (unmounted) and all media related items are grayed out in the menu.



**WARNING:** The media can get extremely hot. Use caution when removing media.

Removing a CFast media card without ejecting (unmounting) first does not damage the media, however, it does increase the risk of file corruption. It is good practice to eject the media before removing or disconnecting. Ejecting the media provides the following benefits:

- Protects the integrity of your recorded data
- Mounts clips instantly to your workstation in post-production

**NOTE:** If you remove media without ejecting (unmounting) first, you receive a warning notification: "Media removed without first ejecting. Data integrity risk." Always eject media before physically removing the CFast media card to protect your media and footage.

## INSERTING THE MEDIA

The camera contains a covered compartment on the right side where you insert the CFast media card.

**WARNING:** Do not attach a label to the CFast media card. The heat generated by the media can weaken the label's adhesive, causing the label to detach inside of the camera. Labels can also diminish heat dissipation and cause excessive wear to the internal components. Removing a label from a CFast media card can possibly deform the card body.



## INSERTING THE CFAST MEDIA CARD

1. Slide the media door latch back, and open the media door.



2. Insert the CFast media card in the slot with the top of the card facing toward the front of the camera. Insert the card until it is firmly seated.
3. Close the media door and make sure that the door latch clicks.
4. If needed, format the CFast media card. Refer to [Secure Format](#) for more information.

## REMOVING THE CFAST MEDIA CARD

**NOTE:** Do not remove the CFast card while the camera is recording or formatting media. Refer to [Media Management](#) for more information.

**WARNING:** The media can get extremely hot. Use caution when removing media.

1. If the camera is on, go to **Menu > Media** and select **Eject**.
2. Slide the media door latch back and open the media door.



3. Press the card eject button above the CFast media card.

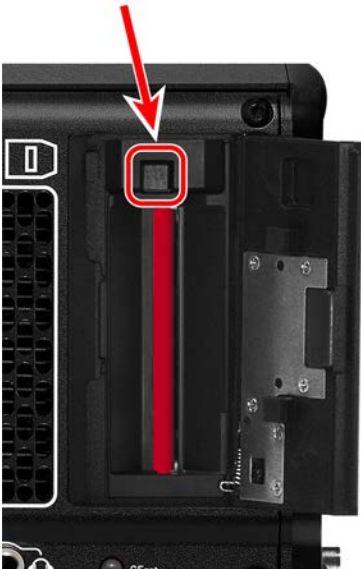

4. Let the CFast media card cool before gently pulling the card out of the slot.

**WARNING:** The media can get extremely hot. Use caution when removing media.

5. Close the media door and make sure that the door latch clicks.

## SECURE FORMAT

A secure format is a low-level format that rebuilds the CFast card file system. A secure format erases all data on the card.

Perform a secure format when the camera is reporting media-related errors.

### PERFORMING A SECURE FORMAT

**CAUTION:** Ensure all data is backed up before formatting a card. **Data erased during formatting cannot be recovered.**

**WARNING:** The media can get extremely hot. Use caution when removing media.

To perform a secure format, follow the instructions below:

1. Go to **MENU > MEDIA > SECURE FORMAT:**

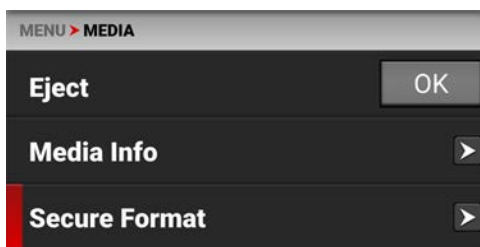

2. From the Secure Format menu, select the desired **Camera ID**, **Camera Position**, **Reel Number** and **Edgecode**. Tap the Format button to start the Secure Format process:

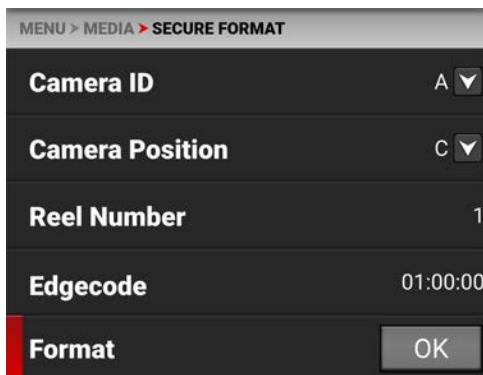

The confirmation message displays:



3. Tap Yes to begin formatting.

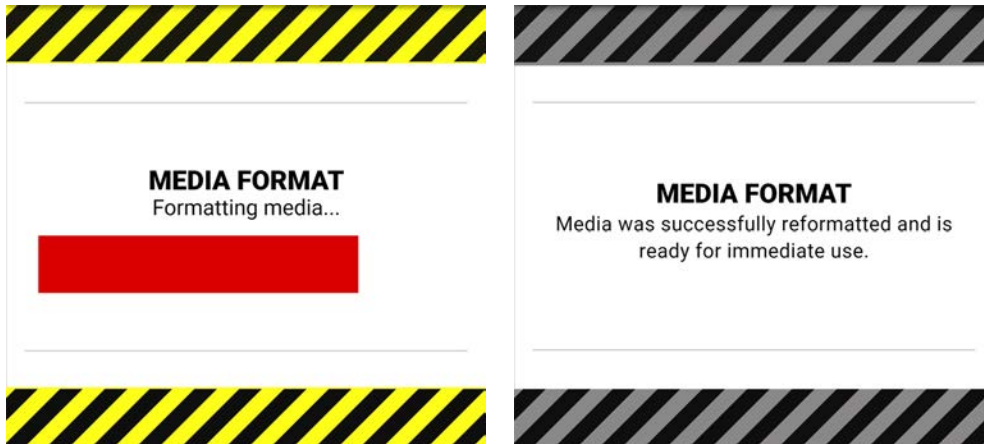

## FORMATTING MEDIA ON A COMPUTER

RED recommends that you only format your CFast media card from a computer when you cannot mount the media to the camera.

## MEDIA INFORMATION

Use the **Media Info** menu to display the CFast media card information.

Media information includes the following:

SETTING	DETAILS
Status	Displays the CFast media card status
Model Number	Displays the CFast media card model number
Serial Number	Displays the CFast media card serial number
Firmware Version	Displays the CFast media card firmware version
Percentage Remaining	Displays the CFast media card's remaining storage*
Time Remaining	Displays the recording time remaining on the CFast media card*

\* with the current project settings

## FILE SYSTEM

The KOMODO camera formats the CFast media card using exFAT. Both Mac® and Windows®-based computers support CFast media cards with this format. Refer to the documentation for your operating system to determine whether there are any limitations to its file format support.

## CLIP NAMING CONVENTION

When you record a clip, the camera creates a unique name for the clip folder that uses the format described in the table below:

NAME	DESCRIPTION	EXAMPLE
Camera ID	The letter assigned to the camera (refer to <b>Camera ID</b> )	A
Reel ID	The reel number assigned to the media (refer to <b>Reel Number</b> )	004
Camera Position	The camera position letter (A-Z) followed by three digits starting with 001 (refer to <b>Camera Position</b> )	C001
Month	Month that the clip is recorded (refer to <b>Date / Time</b> )	12
Day	Day that the clip is recorded (refer to <b>Date / Time</b> )	04
Two Characters	Two random alphanumeric characters generated by the camera to prevent any possibility of duplicates	6M
.RDC	Clip folder extension	.RDC

For example, a sequence of clip folders within a media folder on Camera A may look like this:

- A001\_C001\_12046M.RDC
- A001\_C002\_1204CE.RDC
- A001\_C003\_1204R5.RDC

## CLIP METADATA

The following metadata is recorded for each frame of each clip:

- Audio Data
- Broadcast Wave File (BWF)
- Clip
- Configuration, Camera Name, Network, Model, Model ID, Serial Number
- Copyright
- Date and GMT
- Filename
- Firmware Version
- Frame Guides
- Jam Sync Setting
- Lens and Shutter Speed/Angle Parameters
- Lens Name, Brand, ID, Near Focus, Far Focus
- Location
- LTC User Bits (3 32-bit word reg-dump from ISP)
- Media Serial Number
- Production Name
- REDCODE®
- Reel
- Scene
- Stereo Setup
- Take
- Timecode
- Unit

## MEDIA BEST PRACTICES

This section describes best practices to ensure that your CFast cards continue to provide reliable storage and fast data rates. Following these best practices may prevent your CFast card from becoming fragmented, which can lead to data integrity errors.

- The only files that should be saved from your computer to your CFast card are Preset files, Firmware Upgrade files, and LUTs. DO NOT save other files, folders, or applications to your media.
- DO NOT back up your hard drive to the CFast card. If using a Mac, the system may ask if you want to back up your files to the CFast card using Time Machine; DO NOT use the CFast card as a backup disk.
- DO NOT delete clips off of your CFast card using a computer. Delete clips only by formatting your CFast card in-camera. For more information about formatting your CFast card, refer to [Secure Format](#).
- DO NOT format your CFast card using a computer, unless the CFast card cannot mount to the camera. For more information, refer to [Secure Format](#).
- When ejecting the CFast card from a computer, ensure that the icon has completely disappeared from the Finder window (Mac) or from Windows Explorer (Windows) before removing the CFast card. Sometimes, the pop-up saying that the CFast card has ejected displays too early.
- When the reader has a write-protect switch (such as the [RED CFast 2.0 Reader](#)), it is recommended that you set the card reader to write-protect when uploading clips to prevent connected devices from adding any unwanted data to your CFast 2.0 card.

## INDEXING ON A MAC

**NOTE:** You can use the RED CFast 2.0 card reader with Write-Protect to prevent the Mac OS from indexing your CFast 2.0 card (refer to [RED CFast 2.0 Reader](#)).

Most newer versions of the Mac OS automatically index all external drives when you connect them. This includes when you connect CFast cards.

Indexing makes the connection process take longer. While the CFast card connects to the Mac, DO NOT remove the card. Indexing writes hidden files to the CFast card. When you insert an indexed CFast card in the camera, it can take the camera a while to recognize the hidden files and connect to the CFast card. While waiting for the CFast card to connect, DO NOT remove the CFast card or turn off the camera. After the camera successfully connects to the CFast card, perform a secure format to remove the hidden files. For more information, refer to [Secure Format](#).

## MONITORING

The camera provides several methods for monitoring the image. These monitoring methods include:

- LCD touchscreen
- SDI output to a monitor
- RED Control over Wi-Fi to iOS or Android devices
- RED Control over KOMODO Link Adaptor to iOS or Android devices
- KOMODO Link Adaptor over a USB-C to Ethernet adapter to a computer
- Live Stream

## LCD TOUCHSCREEN

The LCD touchscreen provides a live image from the camera sensor. By using the Monitoring Tools menu, you can display guides, exposure tools, focus tools, and a magnified image.

Tap on the Exposure meter to open the Monitoring tools.

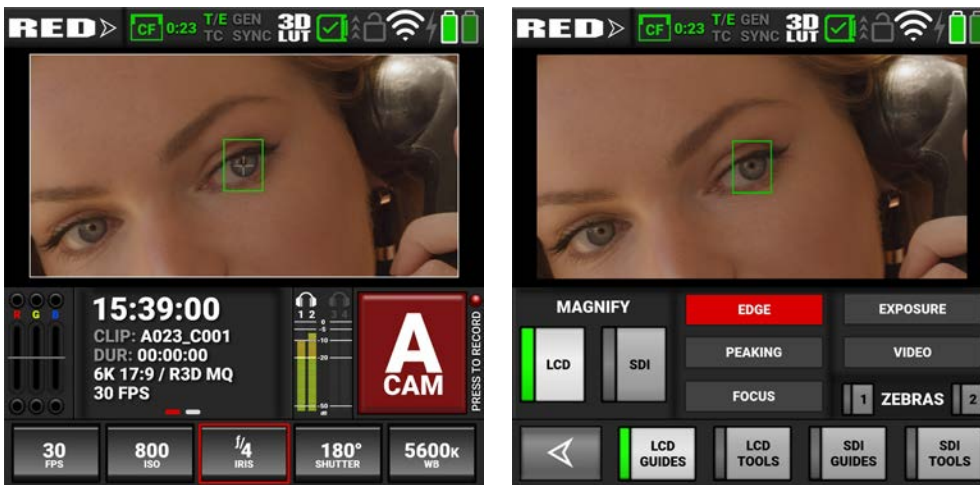

In this example the LCD magnification and LCD guides are enabled. The Autofocus rectangle is also displayed.



## SDI OUTPUT TO A MONITOR

The SDI port provides a 12G SDI signal to allow viewing of the camera image on a 4K SDI monitor. The output signal bit depth is 10-bit 4:2:2.

Use the Monitor menu to select the settings for SDI output, Tools, and Guides (refer to [Monitoring Menu](#))

**WARNING:** Under certain circumstances, it is possible for an SDI connector to incur damage when connected to an accessory and powered without using shielded cables. RED recommends only using high quality, shielded BNC cables that are rated for 12G-SDI signals and only using shielded power cables for powering SDI accessories.

Make sure power is connected to the SDI accessory at all times before you connect the BNC to the camera.

Ungrounded power from SDI accessories can damage the camera's SDI port. To avoid this possible damage, attach the power source to the accessory before attaching it to the BNC cable. When using RED Approved Third Party battery plates, unplug the BNC cable prior to hot swapping.

When possible, avoid using P-Tap (also known as D-Tap) cables to power accessories. To avoid damage when using P-Tap/D-Tap, it's imperative that the connect/disconnect sequence (below) is followed precisely.

## BNC ATTACHMENT INSTRUCTIONS

When attaching SDI accessories:

1. Connect a power source to the SDI accessory; power on the SDI accessory.
2. Ensure a power source is connected to the camera. This ensures both are grounded prior to connecting the BNC. The camera's power state does not have an impact on SDI attachment sequence.
3. Connect the BNC cable to the accessory, then to the camera.

When detaching an accessory mounted to an SDI output, ensure that you remove the BNC connection to the camera before removing power to the SDI device:

1. Shutdown the SDI accessory.
2. Disconnect the BNC cable from the camera.
3. Disconnect the power source from the SDI accessory.

When you need to swap out a battery on an accessory mounted to the camera's SDI port, you must:

1. Shutdown the SDI accessory.
2. Disconnect the BNC cable from the camera.
3. Replace the battery on the SDI accessory.
4. Connect the BNC cable to the camera.
5. Power on the SDI accessory.

For more information, refer to [Preventing Damage to SDI Outputs](#).



Figure: SDI monitor with SDI Advanced Mode enabled

#### SDI port specifications:

- Integrated 12G-SDI with 6G-SDI, 3G-SDI, and 1.5G-SDI modes
- 12G-SDI: Up to 4096 × 2160 10-bit 4:2:2 for 60p
- 6G-SDI: Up to 4096 × 2160 10-bit 4:2:2 for 30p
- 3G-SDI: Up to 2048 × 1080 10-bit 4:2:2 for 60p
- 1.5G-SDI: Up to 2048 × 1080 10-bit 4:2:2 for 30p and 24p
- SMPTE Timecode
- HANC Metadata
- 24-bit 48 kHz Audio

You can enable or disable the image magnification, the focus and exposure tools, and the guides displayed on images sent to the SDI monitor by using the Monitoring tools (refer to [Monitoring Tools](#)).

Tap on the Exposure meter to open the Monitoring tools.



You can enable the following monitoring tools on SDI:

- Magnify
- SDI Guides (refer to **Guides**)
- SDI Tools (refer to **Tools**)

## RED CONTROL

RED Control allows you to use Wi-Fi to connect to the camera and send monitor images to iOS and Android devices.

**NOTE:** You must enable live streaming under **MENU > MONITORING > LIVE STREAM** to enable the image feed.

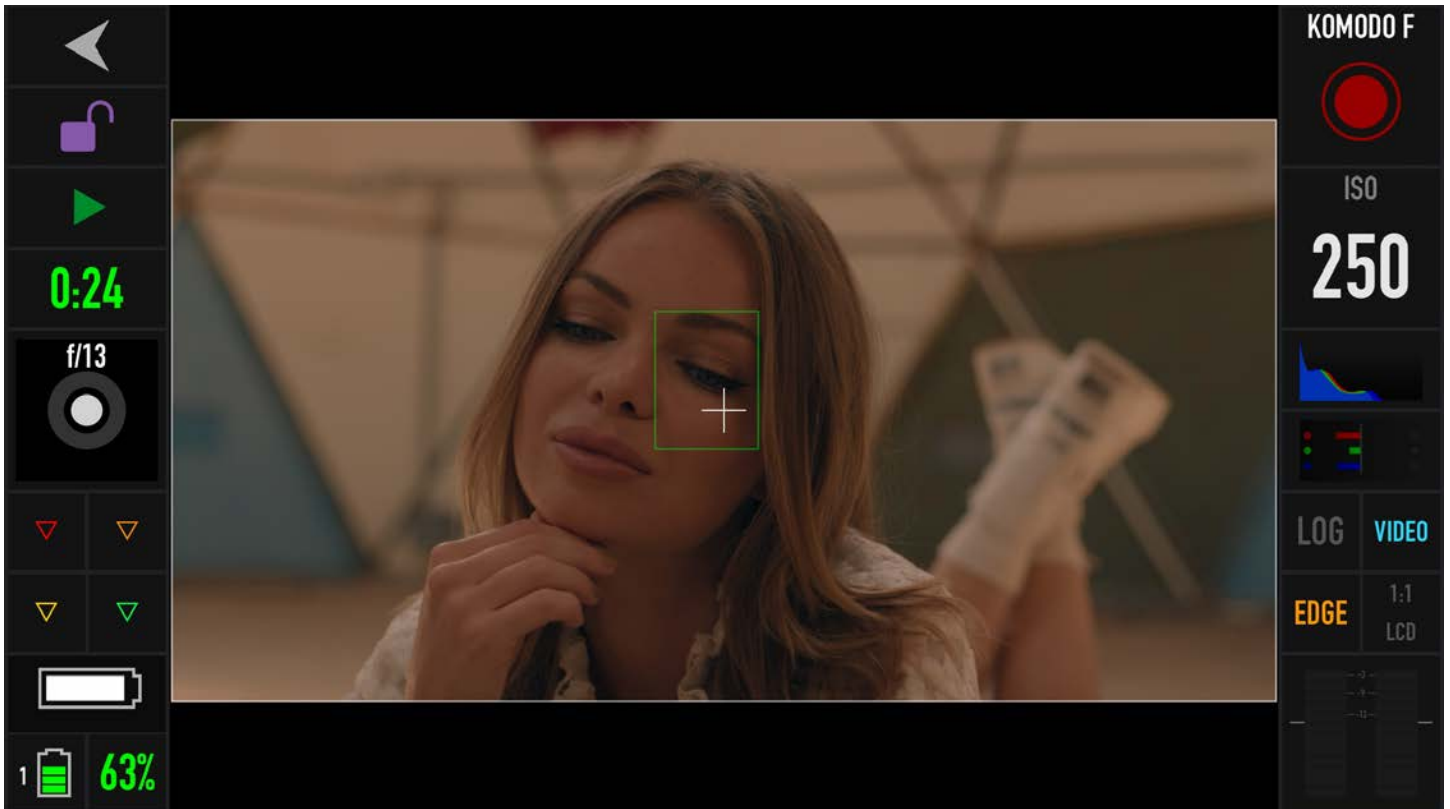

Figure: RED Control phone monitor over Wi-Fi

## KOMODO LINK ADAPTOR

The KOMODO Link Adaptor allows you to use a USB-C cable to connect to the camera and send monitor images in real-time to USB-C devices.

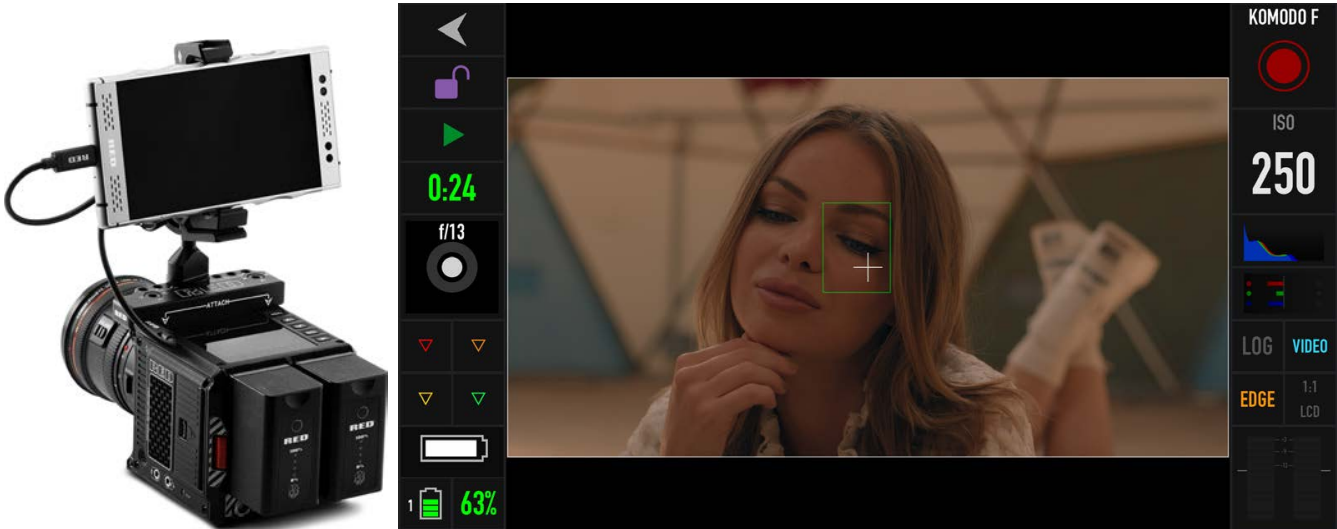

Figure: KOMODO Link Adaptor connected to an Android phone with RED Control

With the use of an Ethernet to USB-C adapter, you can also connect Ethernet devices.

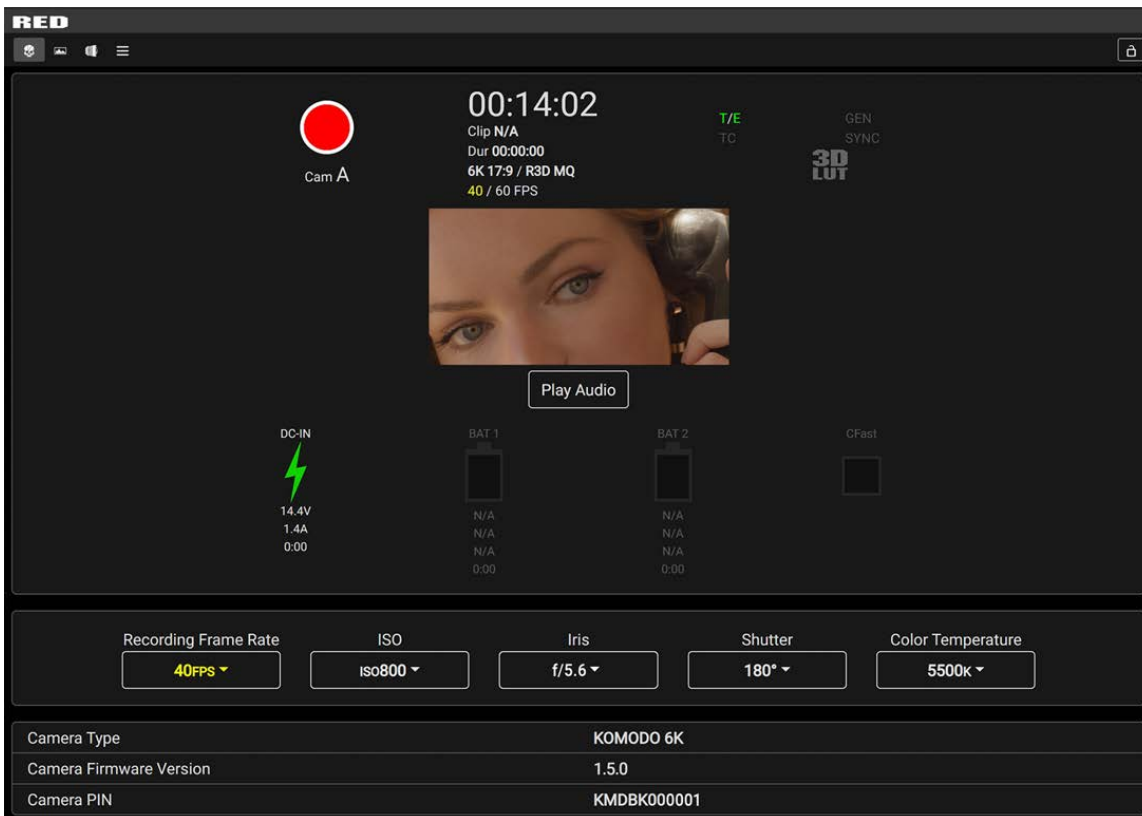

Figure: KOMODO Link Adaptor connected to an Ethernet web browser

You can add :9090 to the end of the URL in your browser to bring up an image-only feed for remote viewing.

**NOTE:** You must enable live streaming under **MENU > MONITORING > LIVE STREAM** to enable the image feed.

## EXPOSURE

The camera offers multiple tools to determine the current image exposure levels and provides the tools to adjust the exposure to the desired levels.

When using the R3D file format, you can correct color temperature and ISO settings at any time. The aperture and exposure time however, are two of the parameters that you cannot corrected later in R3D files.

**NOTE:** ProRes file format burns in ISO and White Balance, and does not allow you to adjust these settings post-recording like you can with the R3D format.

While the correct exposure is always an artistic decision, there are best practices for capturing the most dynamic range while also allowing post production to preserve the intended image information.

The goal is to reduce clipping in the bright and dark parts of the image as much as possible. Otherwise the sensor information is lost in the overexposed and underexposed areas.

The primary tool for determining the exposure levels is the histogram. It shows the exact luminance levels of the red, green, and blue pixels after you apply the ISO and White Balance settings. Monitors have their own color gamuts and brightness levels which makes the monitor less than optimal for determining the camera's exposure levels.

This camera includes a full **Histogram** and a simple RGB raw pixel exposure meter, which allows you to determine proper exposure regardless of the set ISO or camera look (for more information refer to **LCD Touchscreen**).



The full histogram provides information about how the brightness is distributed in the image. This allows you to see how close a scene is to clipping in the light and dark areas, which makes it easy to choose aperture, exposure, and ND filters solutions accordingly.

## Example of overexposure with histogram and exposure meter:



## Example of underexposure with histogram and exposure meter:



## Example of a balanced exposure with histogram and exposure meter:



## FALSE COLOR EXPOSURE TOOLS

While the histogram provides information about the brightness distribution and clipping of the image, it does not show you the areas in the image that are near, or that have reached, clipping. For this, the camera provides image overlays that provide false colors to indicate precise exposure levels.

### FALSE COLOR EXPOSURE MODE

The False Color Exposure mode overlay provides information where the image is close to clipping or already clipping in the highlights (red), midtones (green), and shadows (purple). For more information, refer to [False Color Exposure Mode](#).

Example of Exposure Mode:



### FALSE COLOR VIDEO MODE

The False Color Video mode provides more gradual information about the brightness in different parts of the image. This is helpful when you want to expose skin color at the right level, while ignoring the fact that backgrounds might be overexposed or underexposed (refer to [False Color Video Mode](#)).

Example of Video Mode:



## FOCUS

Focus, like **Exposure** and **Recording Frame Rate** is a property that cannot be fixed easily in post-production. To make sure the camera is focused correctly when you begin recording, it is important to rely on focus tools that do not rely on the visibility on the LCD Touchscreen or a monitor.

The camera interface includes the focus tools you can use to reach the desired image focus (refer to **Peaking**).

## FOCUS PEAKING MODE

The Focus Peaking mode applies a sharpening filter to the image that emphasizes edges of the subject in focus.

Example of Focus Peaking:



## EDGE PEAKING MODE

The Edge Peaking mode hides the image and only shows the edges. This provides the best visual representation of the subject that is currently in focus.

Example of Edge Peaking mode:





## PEAKING PEAKING MODE

The Peaking Peaking mode emphasizes the edges, and it also highlights them by using a selectable color.

Example of Peaking Peaking mode:



## TIMECODE

Timecode provides a mechanism to reference frames from the camera's recorded clips to other devices like cameras and audio recorders. Some devices can also gather other data like lens metadata or camera orientation that is referenced by Timecode to merge the data back together in post-processing.

KOMODO provides two separate Timecode concepts: Time of Day (TOD) and Edgecode. Both TOD and Edgecode are stored in the R3D file. The user can select which Timecode displays on the **LCD Touchscreen** by setting the preference in **Timecode Display Mode**.

## TIME OF DAY

TOD Timecode reflects the time and date the camera recorded each frame. KOMODO synchronizes the TOD Timecode to an external Timecode generator (when one is connected to the **Extension Port**) or synchronizes to the internal real-time clock of the camera.

## SETTING UP TOD TIMECODE

To set up TOD Timecode on the camera, perform the following:

1. Open the Audio / Timecode menu: **MENU > AUDIO / TC:**

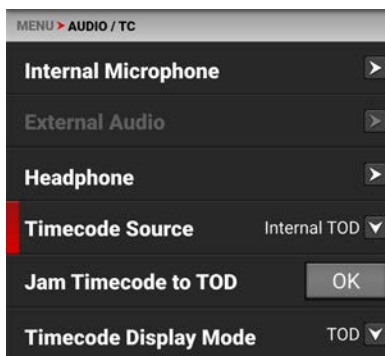

2. Select Timecode Source. The Timecode Source menu opens:

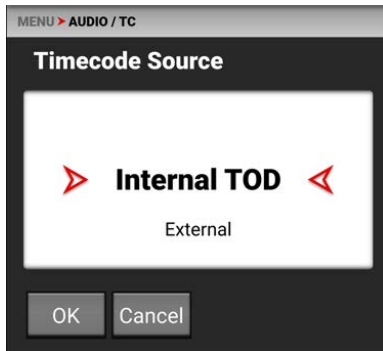

3. Select Internal TOD to use the camera's internal real time clock, or select External to use an external Timecode generator connected to the **Extension Port**.
4. When you select Internal TOD, you can use the **JAM Timecode to TOD** button to synchronize the Timecode to the camera's internal clock.

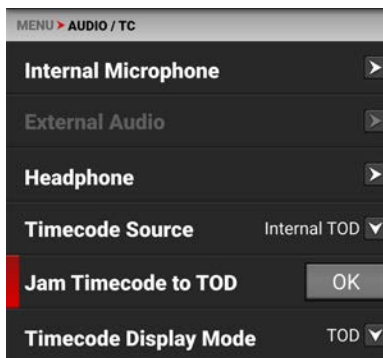

The camera displays the Timecode on the **LCD Touchscreen**



**NOTE:** The timecode is reset when the camera is turned off, unless an external power source remains connected and powered.

## EDGECODE

Edgecode only advances while the camera is recording frames. Each frame is sequential. When the media is replaced, the new media starts the timer over. You can set the Edgecode timer manually by using the **Secure Format** menu.

### SETTING UP EDGECODE TIMECODE

To set up Edgecode Timecode on the camera, perform the following:

1. Open the Audio / Timecode menu: **MENU > AUDIO / TC**:

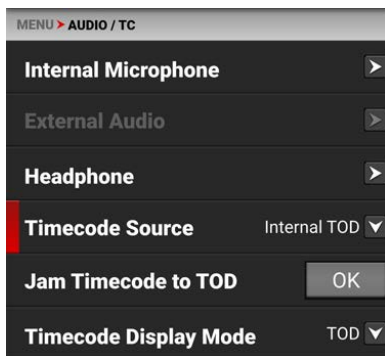

2. Swipe the touchscreen up to scroll down to Timecode Display Mode:

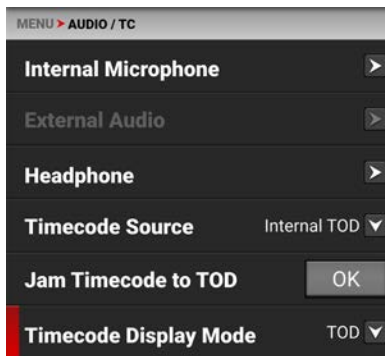

3. Select Timecode Display Mode. The Timecode Display Mode menu opens:

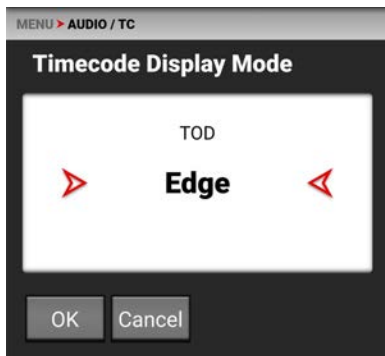

4. Select Edge and tap OK to use Edgecode. The camera displays the Edgecode on the **LCD Touchscreen**



## ZEBRA MODES

Use Zebra mode to enable and adjust the upper and lower values for two (2) independent zebra indicators. Use Zebra 1 for highlight exposure, and use Zebra 2 for mid-tones or shadows. Zebras are disabled by default.

For more information, refer to the [Exposure with RED Cameras: False Color and Zebra Tools](http://www.red.com/red-101/exposure-false-color-zebra-tools) article, available at [www.red.com/red-101/exposure-false-color-zebra-tools](http://www.red.com/red-101/exposure-false-color-zebra-tools).

### ENABLING THE ZEBRA 1 INDICATOR

1. Go to **MENU > MONITORING > TOOLS** and select **ZEBRA 1**.
2. Set a Low IRE of 98.
3. Set a High IRE of 100.

Areas of the image exposed within the IRE range are indicated by red diagonal lines at  $-45^\circ$ .

The default settings are Low IRE = 98 and High IRE = 100.

### ENABLING THE ZEBRA 2 INDICATOR

1. Go to **MENU > MONITORING > TOOLS** and select **ZEBRA 2**.
2. Set a Low IRE of 41.
3. Set a High IRE of 48.

Areas of the image exposed within the IRE range are indicated by green diagonal lines at  $45^\circ$ .

The default settings are Low IRE = 41 and High IRE = 48.

## ZEBRA OVERVIEW

Zebra is a specialty mode that is capable of showing up to two customized overlays with arbitrary IRE ranges. Unlike the other two modes, Zebra indicators appear as diagonal stripes, they are fully configurable, and they have the advantage of preserving a full-color base image.

With traditional video cameras, many used a single zebra to indicate highlight detail. It would often be set at 70% (70 IRE), in part because this is where a white piece of paper would begin to have minimal texture when rendered using a typical contrast curve. Skin tones or skies would be exposed to appear just darker or brighter than these lines. If enabled, a second zebra would typically indicate either mid-tones or shadows. For deep shadows, you can set the second indicator to below 10% intensity or 10 IRE, and set the first indicator to highlights above 85 IRE.

However, as with other IRE-based modes, Zebra mode is only applicable for the current ISO settings (such as with SDI output), not for the raw image data. If anything is changed in post-production, the indicators won't be representative of the final output tones. In those situations, Zebra mode is more of a preview and output brightness tool than an exposure tool.

## PRE-RECORDING CONTENT

This section explains how to use the Pre-Record feature.

To start pre-recording, press the **Record** button.

The LCD changes from the Ready appearance to the Pre-Record appearance:



Press the **Record** button again to start recording.

When you start recording, the appearance of the LCD changes from the Pre-Record appearance to the Record appearance:



The camera adds the Pre-Record clip to the beginning of your recording.

You can touch and hold the Record button on the LCD to disable Pre-Record.

For information about enabling and configuring Pre-Record, refer to [Pre-Record](#).

## CALIBRATING THE SENSOR

Sensor calibration is a process during which the camera optimizes image quality by ensuring that pixel sensitivity remains consistent throughout the sensor.

### WHEN TO CALIBRATE SENSOR

Calibration is required:

- When shooting in an environment where the temperature is significantly different (+/- 30° F...) from the current calibration. The T in the T/E Status Bar indicator will turn yellow.
- After an extreme change in exposure time (+/- 1/2 sec). The E in the T/E Status Bar indicator will turn yellow.
- After each firmware upgrade.

## UPGRADING THE FIRMWARE

Your camera functionality may be upgraded by installing the latest firmware. Make a habit of frequently visiting RED Downloads at [www.red.com/downloads](http://www.red.com/downloads) to check for new versions of camera firmware, updated operation guides, and post production software.

### VERIFYING THE FIRMWARE VERSION

To see the firmware version that is currently installed on your camera, open **MENU > SYSTEM SETTINGS > SYSTEM STATUS > CAMERA INFO**:

...> SYSTEM SETTINGS > SYSTEM STATUS > CAMERA INFO	
Camera Type	KOMODO 6K
Camera PIN	KMDBK800000
Version	1.5.0
Runtime	87.1 Hours

A higher number reflects a later release.

## UPGRADING THE FIRMWARE

Install the most recent firmware. Unless otherwise specified in the release notes, you do not need to upgrade to any firmware in between your current version and the most recent version available online.

**NOTE:** You must calibrate the sensor after upgrading the camera. For more information, refer to [Calibrating the Sensor](#).

1. Download the most recent firmware for your camera from RED Downloads at [www.red.com/downloads](http://www.red.com/downloads).
2. Unzip the firmware zip file.
3. In the unzipped folder, navigate to the **upgrade** folder.
4. Copy the **upgrade** folder and its contents to the root level of the CFast media card directory.
5. Eject the CFast media card from your computer and remove it.
6. Insert the CFast media card in the camera.

- From the camera UI, navigate to the **Maintenance Menu**.

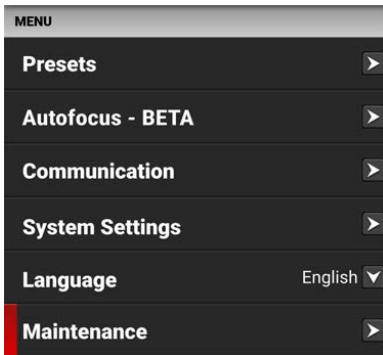

- From the Maintenance menu, tap the **OK** button next to **Upgrade**.

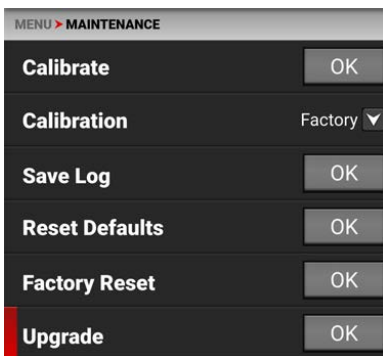

The Firmware Upgrade confirmation screen displays:



- Tap **Upgrade** to confirm. The Firmware Upgrade progress screen displays:



During the upgrade, the fans run at high speed and the following occurs:

- The camera displays the **Shutting Down...** message and reboots.
- The camera restarts and displays the **Initializing...** message.
- The camera displays the **Firmware Upgrade** progress screen:



The Firmware Upgrade success message screen displays with a **Restart** button:

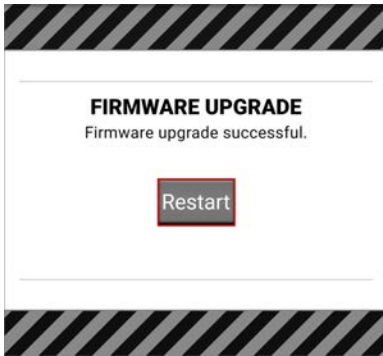

10. Tap the **Restart** button. The camera displays the **Shutting Down...** message and reboots again.
  - The new **Initializing** progress screen displays.
  - The **Firmware Upgrade** progress screen displays.
11. The camera restarts displaying the KOMODO start screen, the **Initializing** progress screen, and then the Software License Agreement (SLA) displays:

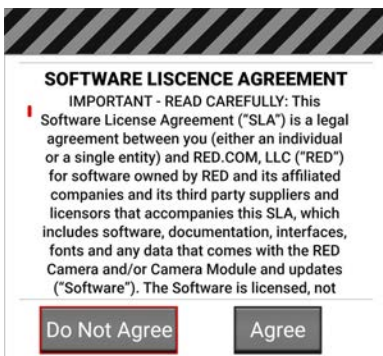

12. Select **Agree**. If you do not agree to the SLA, the camera cannot be used. The SLA continues to display until it is accepted.
13. Recalibrate the camera before recording.



## KOMODO LINK ADAPTOR

The **KOMODO Link Adaptor** offers a USB-C connection that provides communication support for Android devices, Apple devices, and Ethernet devices.

This section includes instructions for:

- [Android Configuration](#)
- [Apple Configuration](#)
- [Network Configuration](#)

## ANDROID CONFIGURATION

The **KOMODO Link Adaptor** offers a USB-C connection that provides communication support for Android devices.

### CONNECTING TO AN ANDROID DEVICE

You must install the **KOMODO Link Adaptor** before you can use USB-C to connect the camera to an Android device.

1. From the Google Play store, download the **RED Control App** to the Android device.



2. Connect the Android device to the camera with a USB-C cable.

3. Navigate to the KOMODO Communication menu and select KOMODO Link Adaptor.

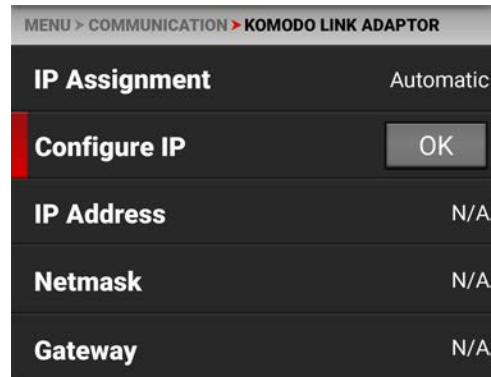
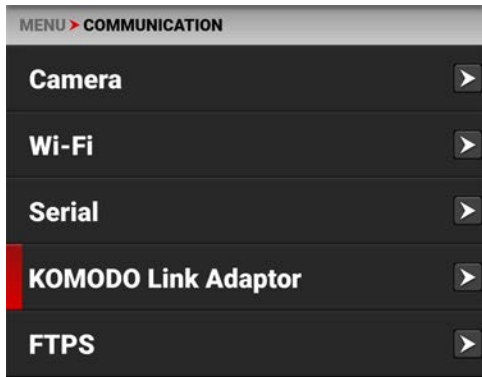

4. Open the Android device settings by tapping the Settings icon (gear).

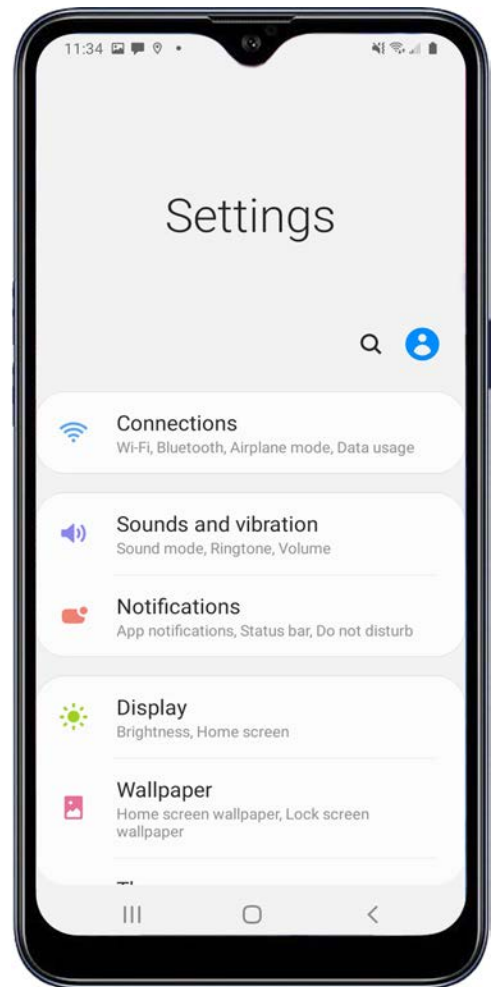

## 5. Select Connections.

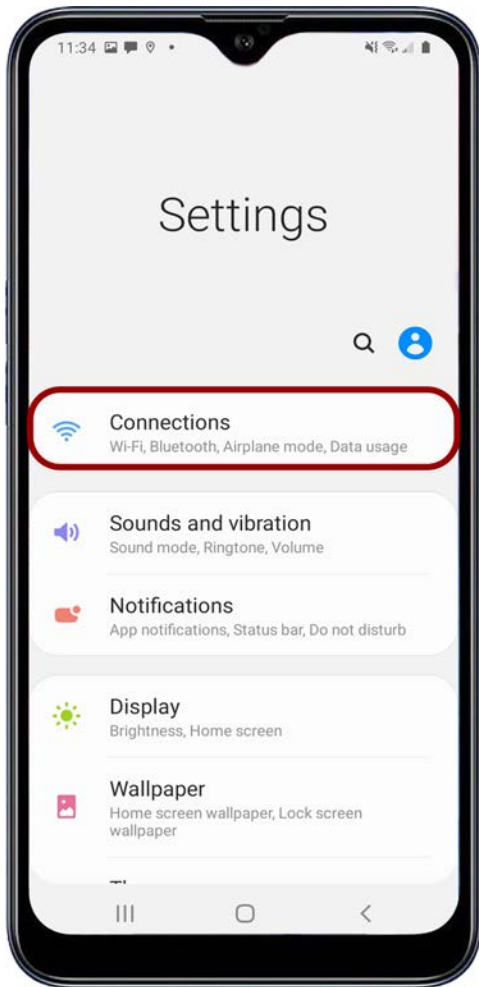

## 6. Select Mobile Hotspot and Tethering.

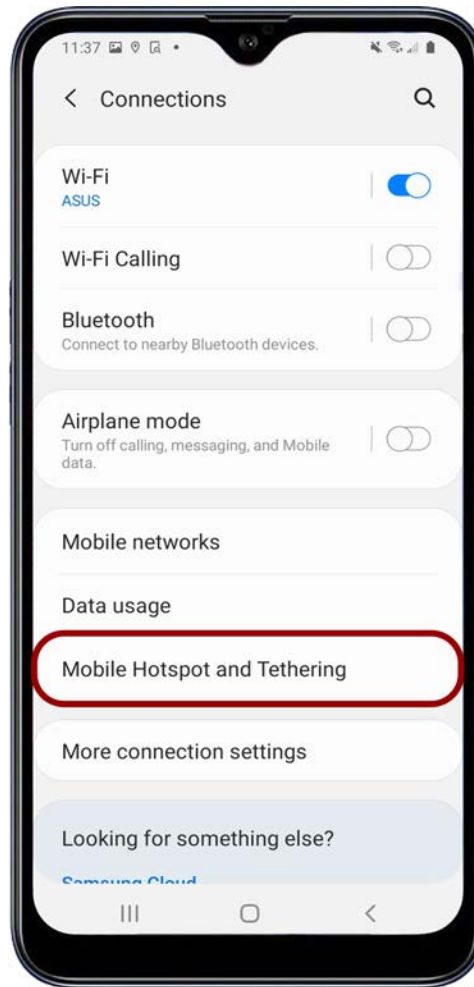

**NOTE:** Mobile Hotspot and Tethering is only available on Android devices with cellular capability.

## 7. Enable USB Tethering.

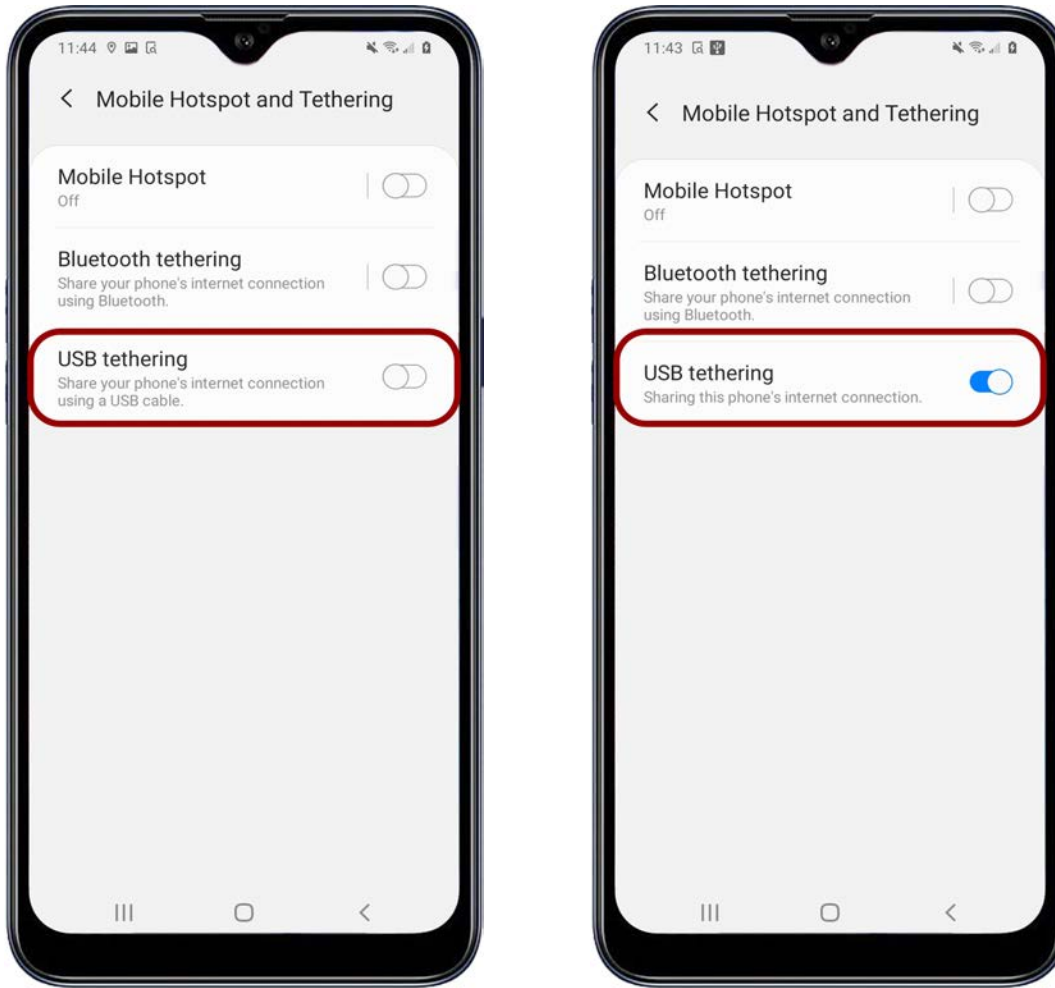

The camera displays the Android device's IP address in the KOMODO Link Adaptor screen:

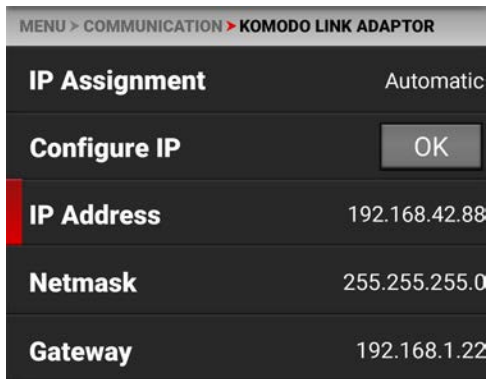

8. From the Android device, tap the RED Control icon to open the RED Control app.

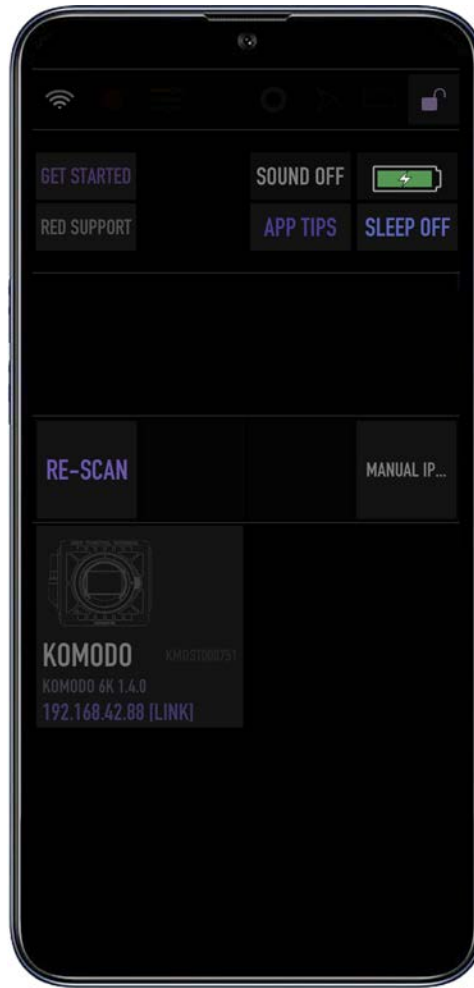



The RED Control app displays the camera connection icon.

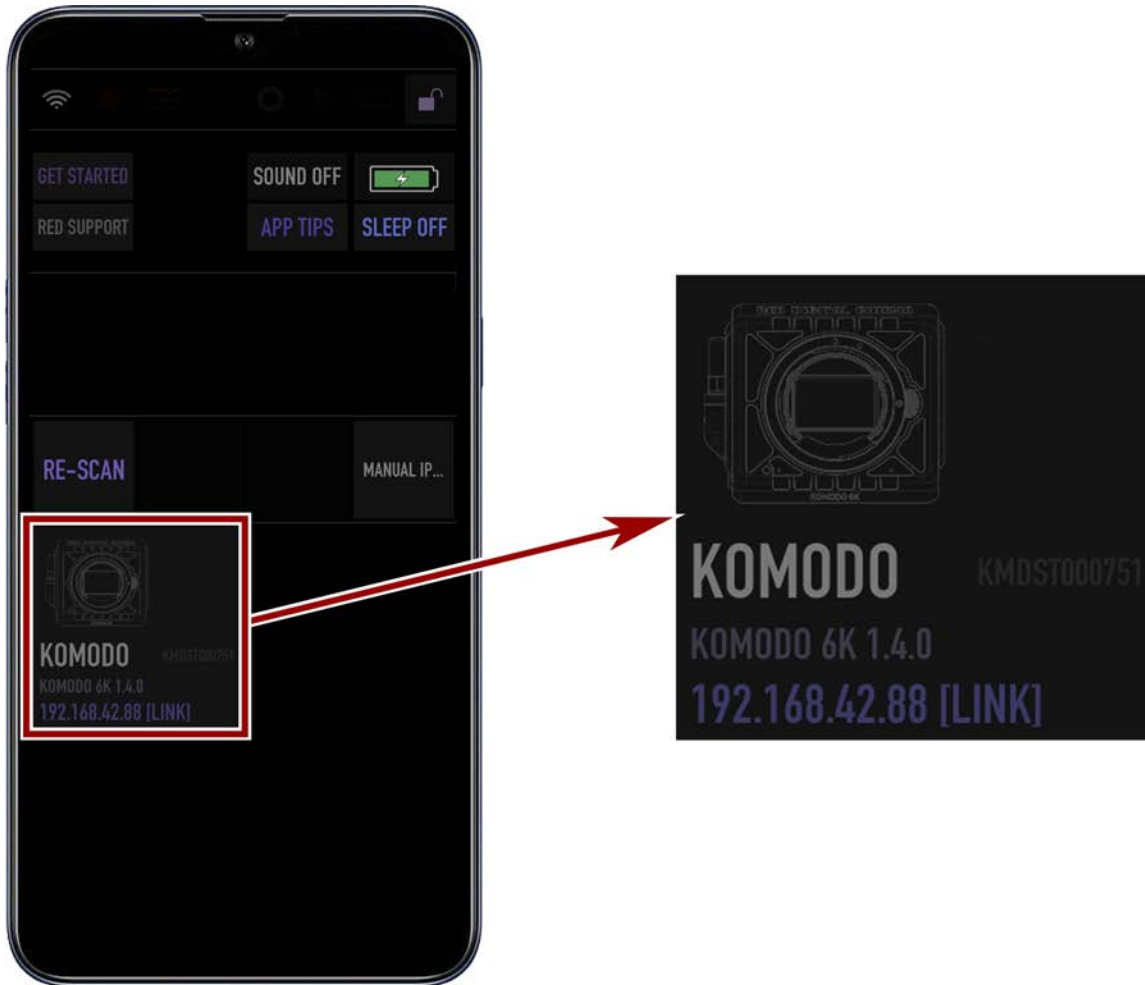

9. Tap the icon to open the RED Control app tools for the tethered camera.

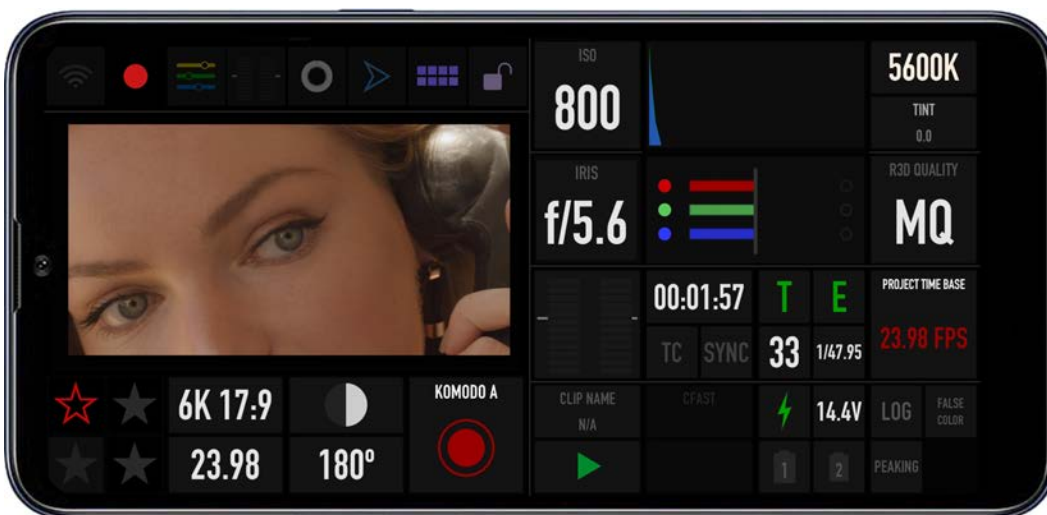

From here you can use the **RED Control App** to monitor and control the camera.

## APPLE CONFIGURATION

The **KOMODO Link Adaptor** offers a USB-C connection that provides communication support for Apple devices.

### CONNECTING TO AN APPLE DEVICE

You must install the **KOMODO Link Adaptor** before you can use USB-C to connect the camera to an Apple device.

1. From the Apple store, download the **RED Control App** to the Apple device.

**Note:** Scroll to the bottom of the user agreement to accept the agreement.

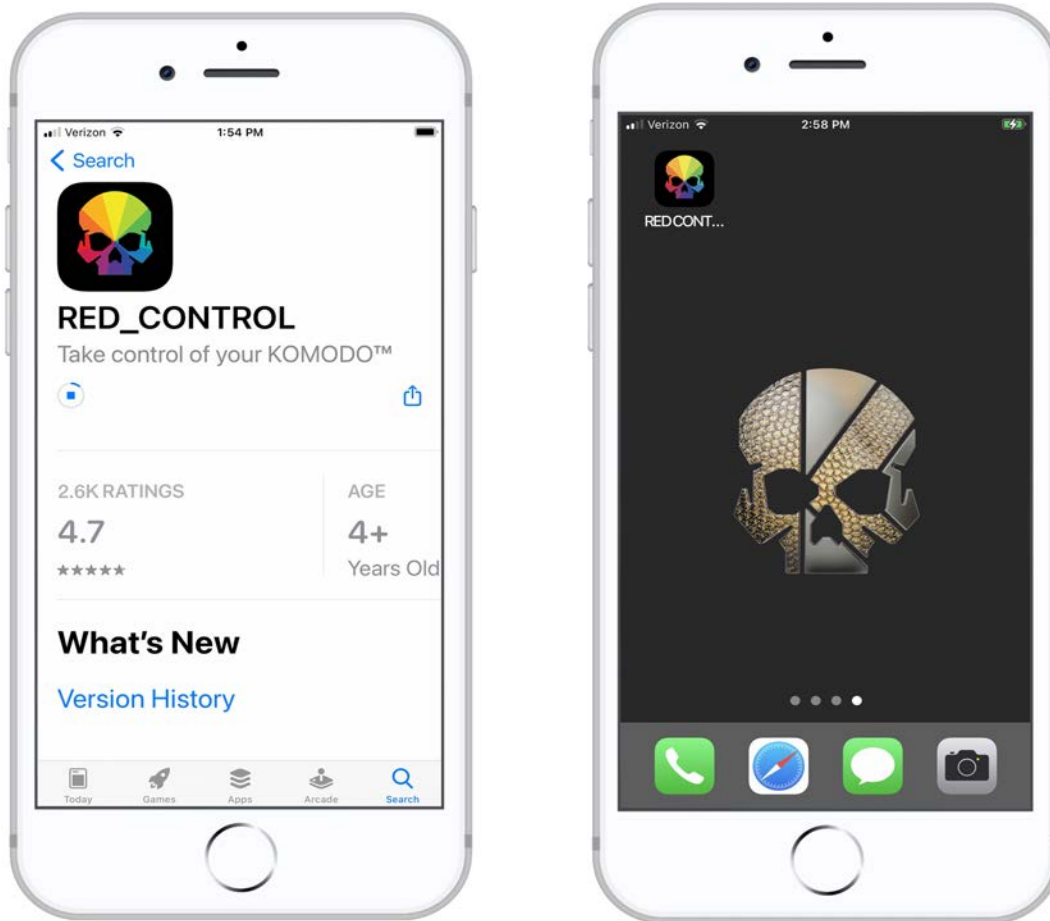

2. Connect the Apple device to the camera with a USB-C cable.

3. Navigate to the KOMODO Communication menu and select KOMODO Link Adaptor.

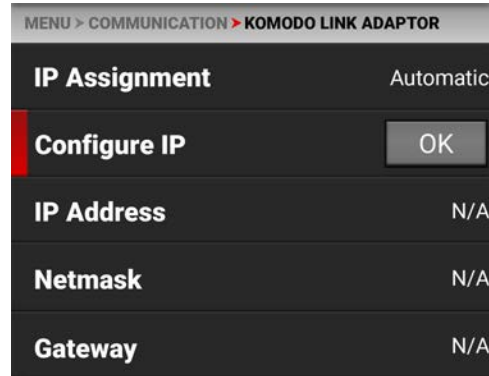
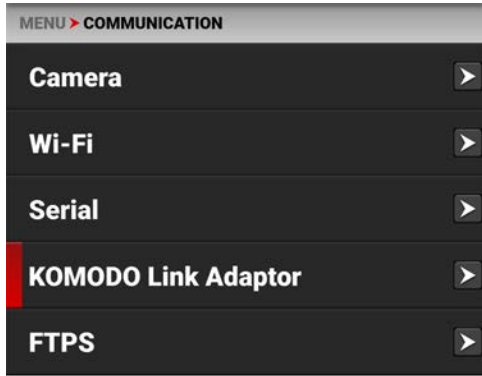

4. Open the Apple device settings by tapping the Settings icon.

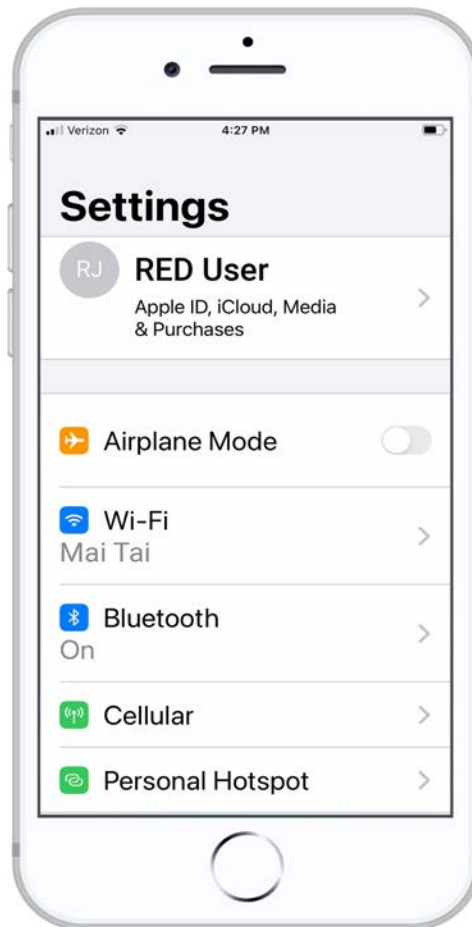



## 5. Select Personal Hotspot.

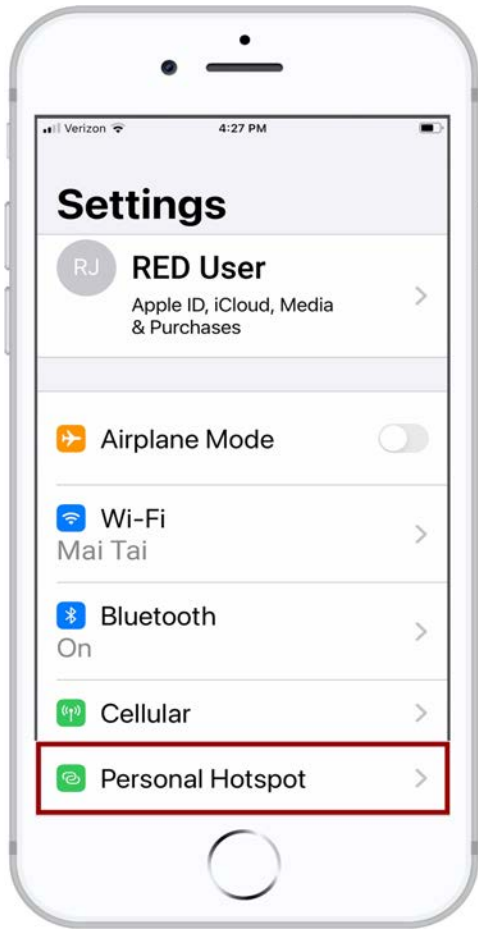

6. Allow others to join.



7. The Apple device prompts you to acknowledge that you trust the computer (camera).



The camera displays the Apple device's IP address in the KOMODO Link Adaptor screen:

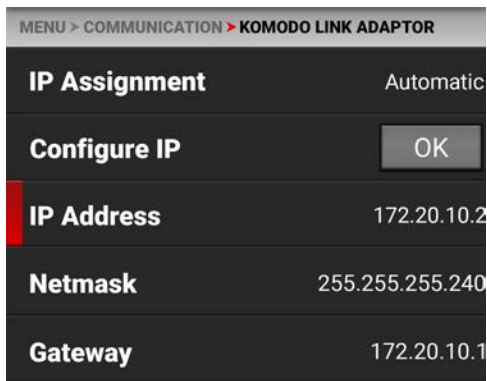

8. From the Apple device, tap the RED Control icon to open the RED Control app.

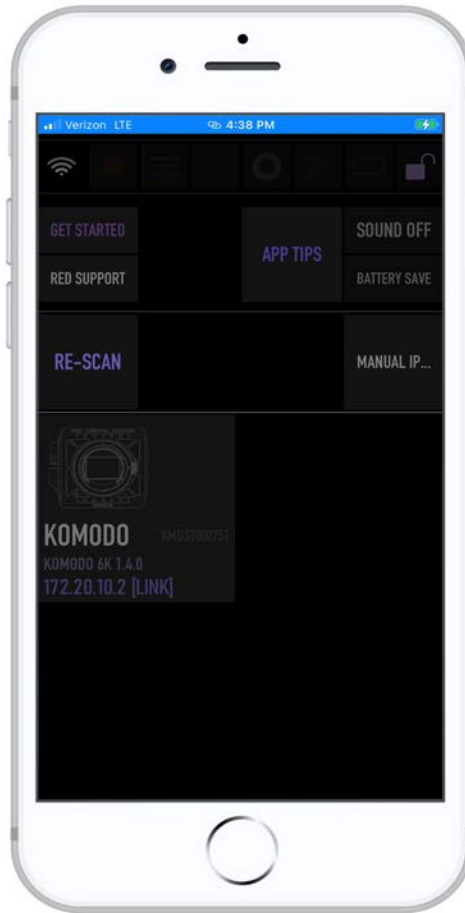

The RED Control app displays the camera connection icon. The word LINK is visible after the IP address.



9. Tap the icon to open the RED Control app tools for the connected camera.

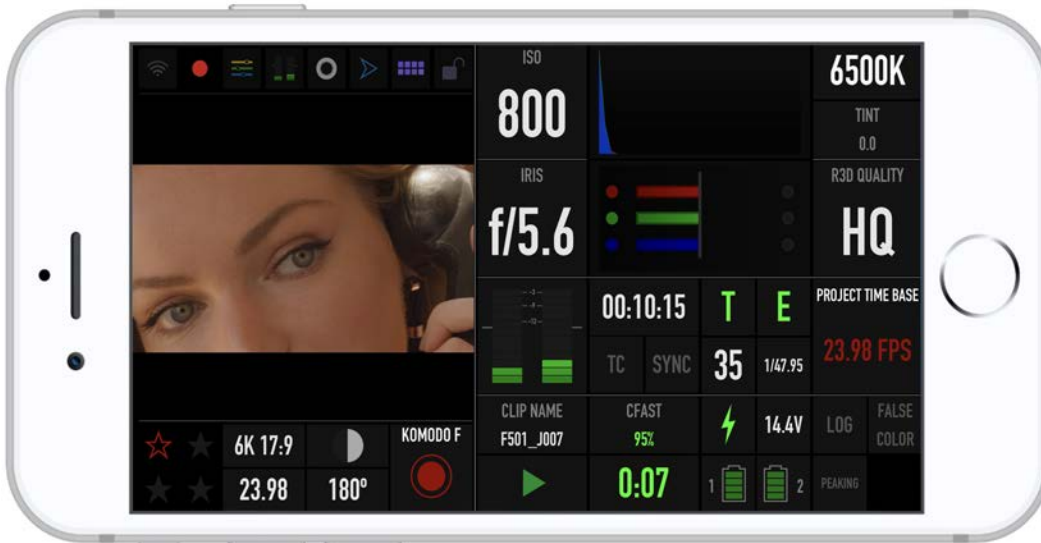

From here you can use the RED Control App to monitor and control the camera.

## NETWORK CONFIGURATION

The **KOMODO Link Adaptor** offers a USB-C connection that provides communication support for Ethernet networks.

### CONNECTING TO AN ETHERNET NETWORK

You must install the **KOMODO Link Adaptor** on the camera before you can use a USB-C to Ethernet adapter to connect the camera to an Ethernet network.

1. Connect the camera to the Ethernet network using the USB-C to Ethernet adapter.
2. From a Wi-Fi-enabled device, select the Wi-Fi connection to which the camera is connected.



3. Open RED Control on the Wi-Fi-enabled device.

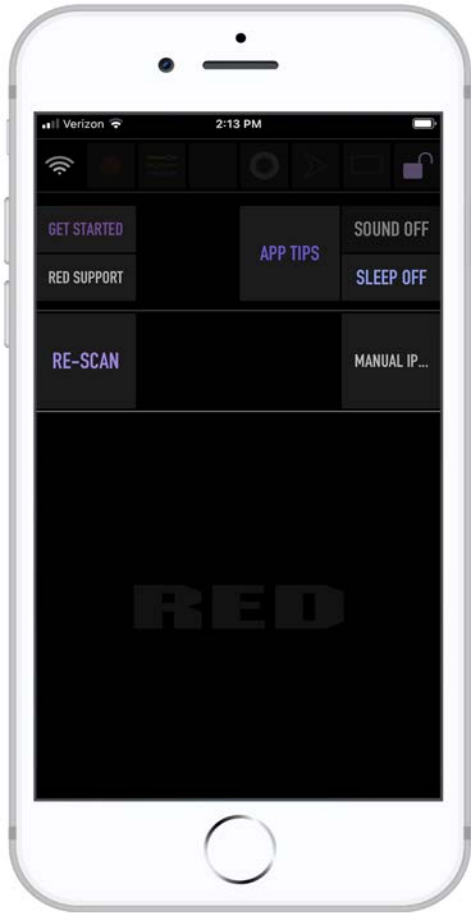

4. Tap RE-SCAN.  
The camera icon displays.

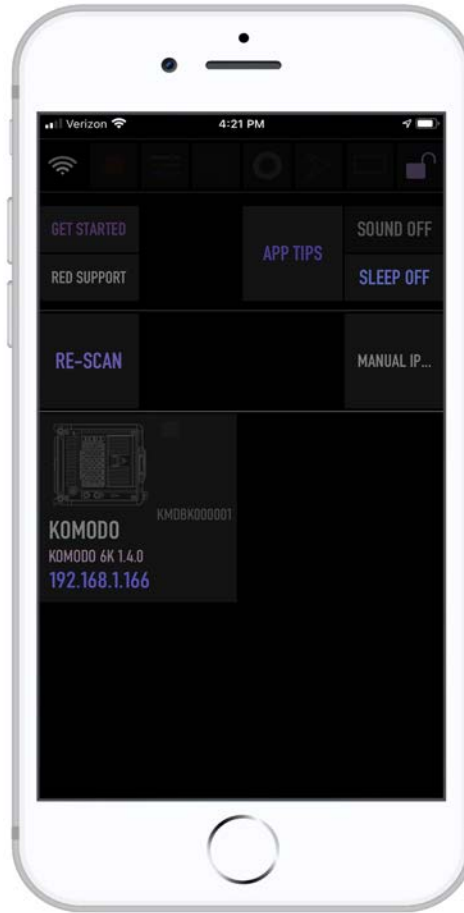

The camera icon displays the camera's Ethernet IP address:

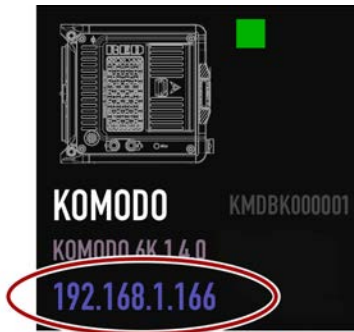

5. Tap the camera icon to open the RED Control app tools for the networked camera.



6. Open a browser from a computer connected to the Ethernet network.
7. In the browser address field, enter the camera IP address displayed on the RED Control camera icon. The RED Control tools are displayed in the browser.

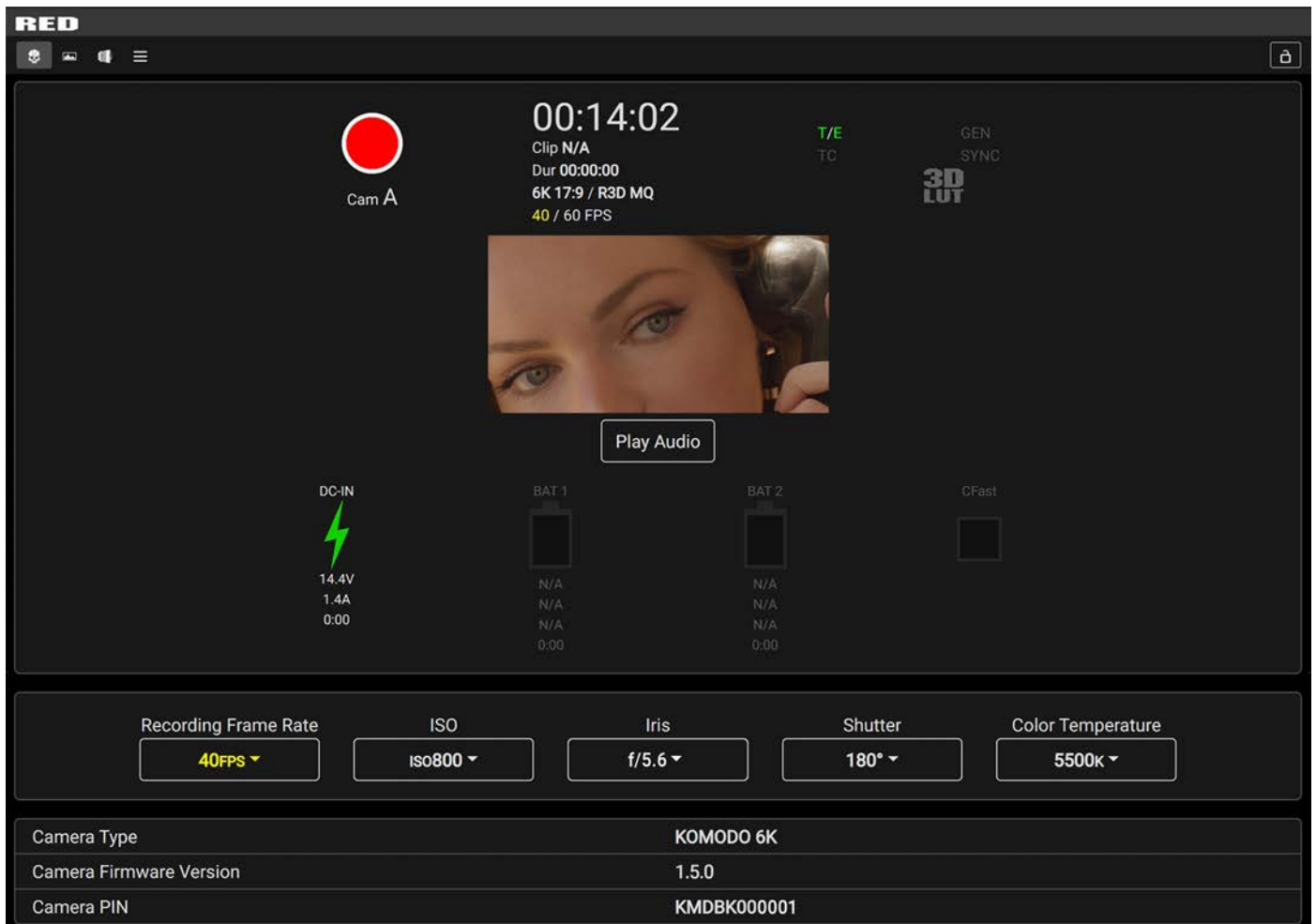



## FTPS CONFIGURATION

The File Transfer Protocol Secure (FTPS) offers a fast and secure system for transferring data to and from the camera. FTPS is supported by firmware versions 1.5 and higher. FTPS is available when the camera is enabled and connected to a network over WiFi or through the KOMODO Link Adaptor's USB-C port to an Ethernet adaptor.

The settings for using FTPS on the camera include:

- **Protocol:** FTP or FTPS
- **Host:** [IP ADDRESS OF THE CAMERA]
- **Port:** 21
- **Encryption:** TLS/SSL Explicit encryption
- **Username:** [USERNAME IN FTPS MENU SETTINGS]
- **Password:** [PASSWORD IN FTPS MENU SETTINGS]
- **Logon Type:** Normal

### NOTE:

- File transfer speeds may vary depending on the strength of the signal (when using WiFi) and the amount of network traffic. For the fastest and most reliable data transfer, we recommend using a hard-wired connection.
- Steps may differ depending on which FTP software you wish to use, consult your software's user guide for additional assistance.
- When setting up FTP, make sure you use FTP or FTPS and not SFTP as these are different protocols.
- For security reasons, the FTPS host name and password are only displayed on the camera FTPS menu.

## CAMERA SET-UP

1. Connect your camera to the network with the desired connection method (Ad-Hoc, Infrastructure or hard-wired) and verify the connection. A successful connection is confirmed when the camera displays an IP address in the WiFi or KOMODO Link Adapter settings menus.

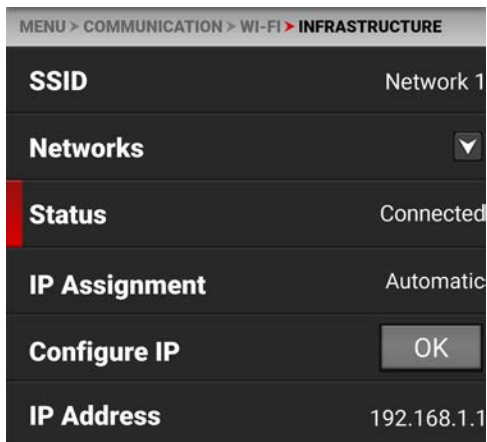

- Navigate to Menu > Communication > FTPS. Take note of the username and password. You can also enter a new password.

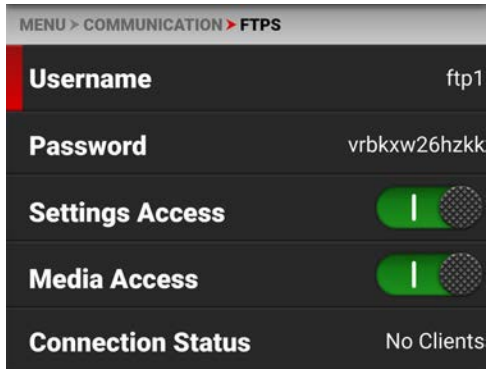

- Enable the permissions you want users to have access to by toggling Settings Access or Media Access to the on or off position. The media folder will display as an empty folder on the FTP App when Media Access is disabled (off).
- The camera is now set-up on the network.

## SOFTWARE SET-UP (FILEZILLA)

- In FileZilla, enter the following settings:

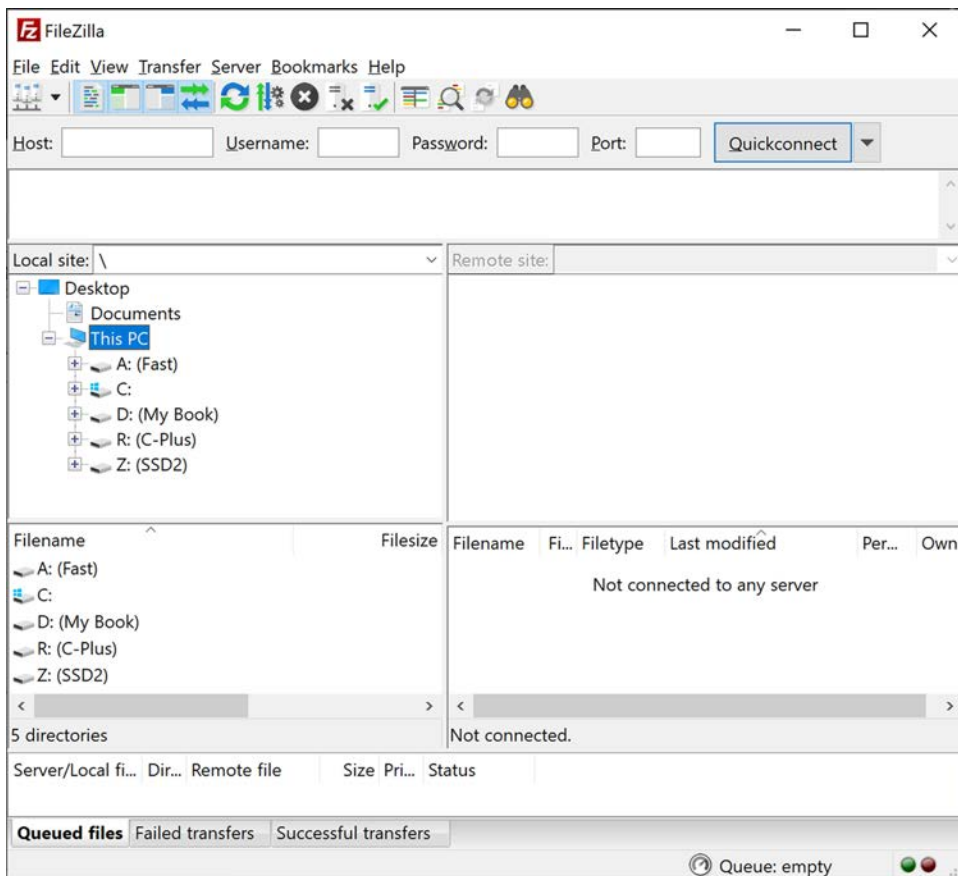

- Host: ftp://Camera's IP Address - Example: ftp://192.168.1.93
- Username: Username displayed in FTPS menu
- Password: Password displayed in FTPS menu
- Port: leave blank

2. Press Quickconnect. Depending on the permissions you will now have access to the desired folders.

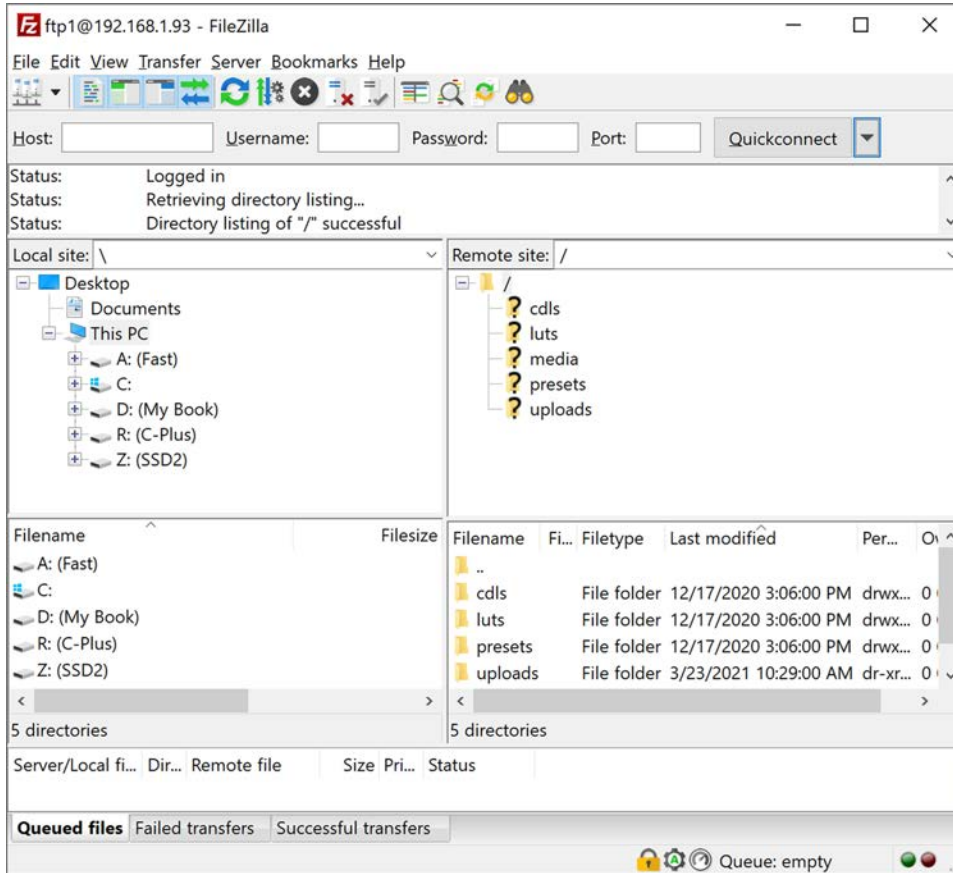

The camera FTPS menu Connection Status displays Connected:

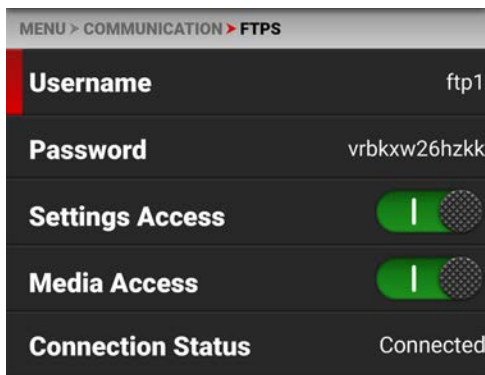

## ADDITIONAL INFORMATION

When uploading files to the camera make sure that you use the 'upload' folder & then the desired sub-directory of luts, cdls, presets or upgrade. Media cannot be uploaded to the camera.

The data rate of the FTPS transfer with encryption maxes out at roughly Gigabit Ethernet speeds.

Estimated download time for a full 256 GB is approximately 47 minutes when using a wired connection.

## SYSTEM MAINTENANCE

All RED products are designed for rugged durability, but precision instruments demand proper care. Follow the instructions in this section to clean, maintain, and store your devices.

**WARNING:** DO NOT rinse or immerse the camera or other accessories in water. Keep dry at all times.

**WARNING:** DO NOT use soaps, detergents, ammonia, acetone, alkaline cleaners, abrasive cleaning compounds, or solvents. These substances may damage lens coatings and electronic circuitry.

**WARNING:** DO NOT use an excess of cleaning solution.

**WARNING:** DO NOT reuse swabs or wipes.

**WARNING:** DO NOT attempt to clean the sensor or optical cavity for any reason. If the sensor becomes dirty, submit a Support ticket at <https://support.red.com>.

**WARNING:** DO NOT attempt to modify, dismantle, or open the camera, lens, or other accessory as doing so may expose you to electric shock and serious injury. There are no user-serviceable parts inside. Alteration or repairs made to the camera or accessories, except by a RED authorized service facility, voids all warranties.

**WARNING:** Use caution with compressed air and gas dusters, since the high pressure, oily residue, cold air, particulates, and moisture may cause damage. You may use a filtered, non-residue gas duster to clean non-critical areas, such as around the fans and other recesses on the exterior of the camera. Damage to the camera or other components of the camera system caused by using compressed air or gas dusters is not covered under warranty.

**WARNING:** DO NOT use compressed air and gas dusters on the sensor or on any optics.

**WARNING:** DO NOT use compressed air and gas dusters on or around the integrated microphones on the front of the camera.

## EXTERIOR SURFACES

Use a filtered, non-residue gas duster to clean non-critical areas, such as around the fans and other recesses on the exterior of the camera.

Clean with a dry lint-free cloth. When cleaning your camera and accessories, remember that the devices are not waterproof and moisture can damage electronic circuitry.

## STORAGE

**WARNING:** DO NOT store the camera or accessories in any place with extreme temperatures, direct sunlight, high humidity, severe vibration, or strong magnetic fields.

## LCD SCREEN

This section explains how to clean the built-in LCD screen.

### APPROVED LCD SCREEN CLEANERS

Use only the following products to clean the built-in LCD screen:

- Ionized rubber air bulb
- Delkin Devices Sensor Solution®
- Lens swabs
- Dry optical wipes

**NOTE:** Before cleaning the screen with swabs or wipes and a cleaning solution, ALWAYS use an ionized rubber air bulb to remove any solid particles. Cleaning the screen without removing solid particles increases the risk of scratching the screen.

### PROHIBITED LCD SCREEN CLEANERS

DO NOT use any of the items listed below to clean the built-in LCD screen. These products have not been tested on RED products and may cause damage or streaking.

- Windex
- Solvents
- Gas dusters
- Compressed air
- Rubbing alcohol
- Isopropyl alcohol
- Third-party cleaning kits
- Pancro Professional Lens Cleaner (or equivalent)
- Pre-packaged lens cleaner containing any additives, such as detergent, anti-static compounds, or fragrance.

**WARNING:** Damage to the LCD screen or other components of the camera system caused by using prohibited cleaners is not covered under warranty.

## WATER DAMAGE

If your device has come in contact with water or you suspect water damage, submit a Support ticket at <https://support.red.com> immediately.

**WARNING:** DO NOT attempt to power any device that may have water damage.

**WARNING:** DO NOT place the device in a container of rice, silica gel, or desiccant packets in an attempt to dry the device.

# A. TROUBLESHOOTING

## GENERAL TROUBLESHOOTING TIPS

This section describes general troubleshooting tips:

- Check the current firmware on the camera. If newer firmware is available from RED, download and install that firmware.
- Check the [Known Issues List](#) to see if the issue has already been identified by RED.
- Turn the camera off and on.
- Try using fresh media.
- Try different cables and make sure that the cables are properly attached.
- Remove all accessories and then re-attach them one-by-one. This process may help you identify whether the issue is specific to a particular accessory.
- Reset the camera to its default settings.

## CONTACT SUPPORT

















If you are unable to resolve an issue, submit a [Support ticket](#). Include the following with the request:

- A Log file. For more information, go to [Save Log](#).
- A list of devices, lens, and third-party accessories that were attached when the issue occurred.
- The camera power source used when the issue occurred (include battery types, power devices, and power cables).
- A description of the issue that occurred.

## STATUS ICONS

The following is a table of the camera's status icons.

ICON	DESCRIPTION
	The CFast 2.0 media card is good (  and recording time remaining)
	The CFast 2.0 media card is missing
	The CFast 2.0 media card is incompatible
	The sensor temperature (T) and exposure (E) calibration are good
	The sensor temperature (T) requires calibration
	The sensor exposure (E) requires calibration
	Gray indicates that no Timecode generator signal is detected
	Green indicates that the Timecode source is connected and jammed
	Red indicates that the Timecode source is connected and not jammed
	White indicates that the Timecode source is jammed and not connected
	Yellow indicates that the Timecode source is cross-jammed (at a different <b>Project Time Base</b> )
	Gray indicates that no Genlock signal is detected
	Green indicates that the camera is receiving and is locked to a Genlock signal
	Red indicates that the camera is receiving and is not locked to a Genlock signal
	Gray indicates that no synchronization is detected
	Green indicates that the camera's sensor is synchronized with Timecode and that the camera's output is synchronized with a Genlock signal
	Yellow indicates that the camera's sensor is <b>NOT</b> synchronized with Timecode and that the camera's output is synchronized with a single camera or a Genlock signal
	Gray indicates that no 3D LUTs are in use
	White indicates that the camera is using a 3D LUT
	Camera temperature is good
	Camera overheating warning
	Camera overheating

ICON	DESCRIPTION
	Camera shutting down
	Gray indicates no FTPS data is transferring
	Green arrows indicate FTPS data is transferring
	Gray and open indicates that the camera LCD is unlocked
	White and closed indicates that the camera LCD is locked
	Gray and empty indicates that no Wi-Fi signal is detected
	White bars indicate the strength of the Wi-Fi signal detected (Infrastructure)
	White antenna indicates that Wi-Fi signal is broadcasting (Ad-hoc)
	Gray indicates that no DC power is connected
	Green indicates that the camera is receiving DC power
	Gray indicates that no battery is connected
	White indicates that the battery is connected and green shows the relative level of charge remaining
	Yellow indicates 10 minutes of power remaining
	Red indicates less than 5 minutes of power remaining
	Gray question mark indicates no communication with the battery and no power
	White question mark indicates no communication with the battery and power
	Gray exclamation point indicates error communicating with the battery and no power



## B. MECHANICAL DRAWINGS

**NOTE:** Dimensions are shown in mm.

### FRONT VIEW

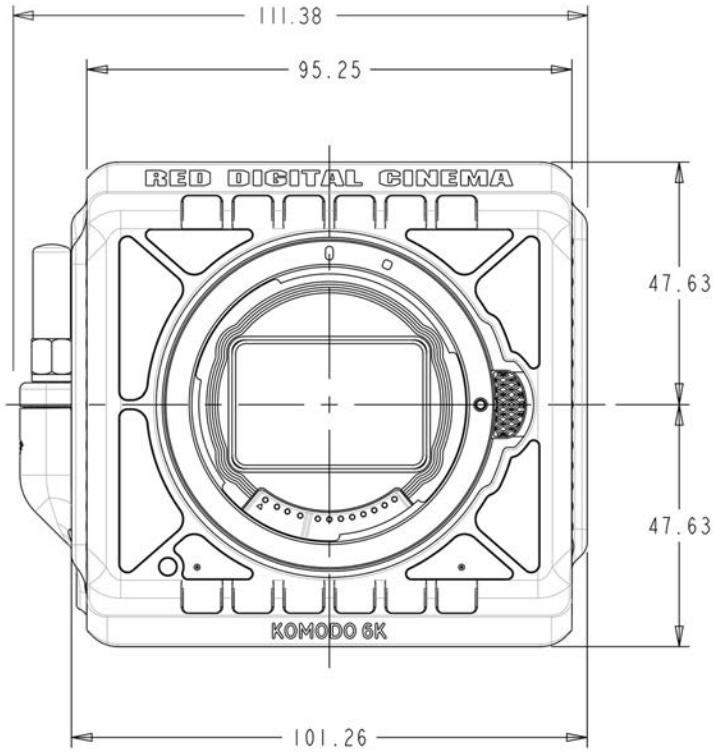

Figure: Camera Front View

## BACK VIEW

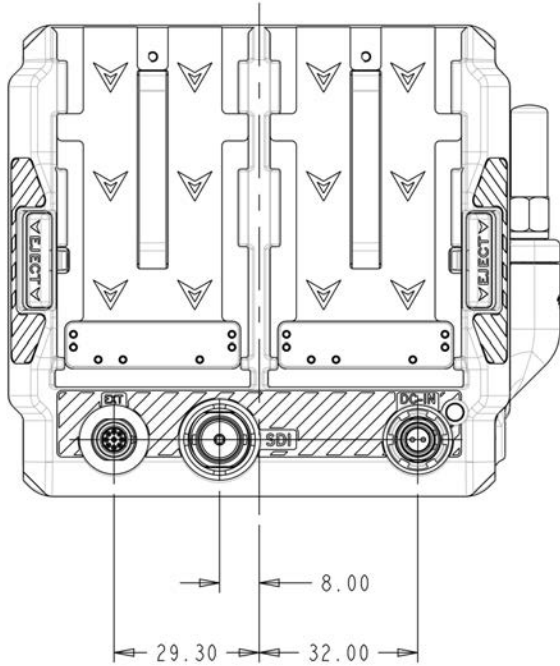

Figure: Camera Back View

## RIGHT SIDE VIEW

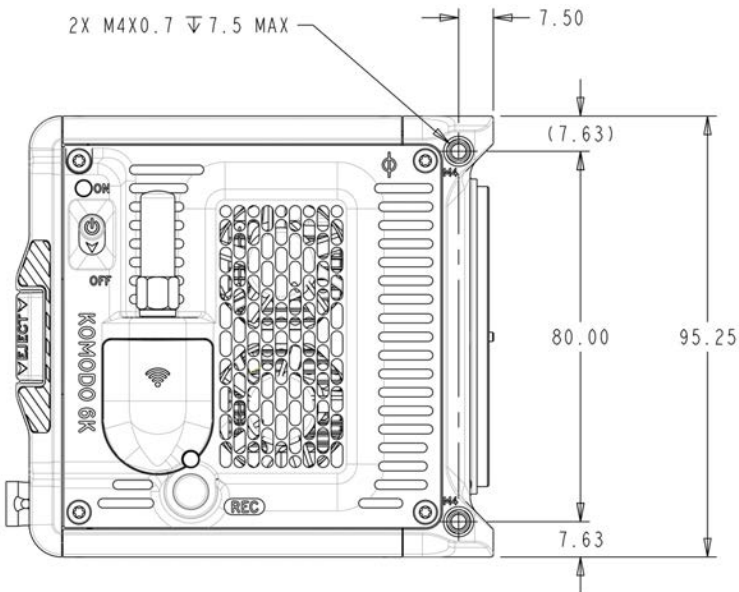

Figure: Camera Side View (Right)

## LEFT SIDE VIEW

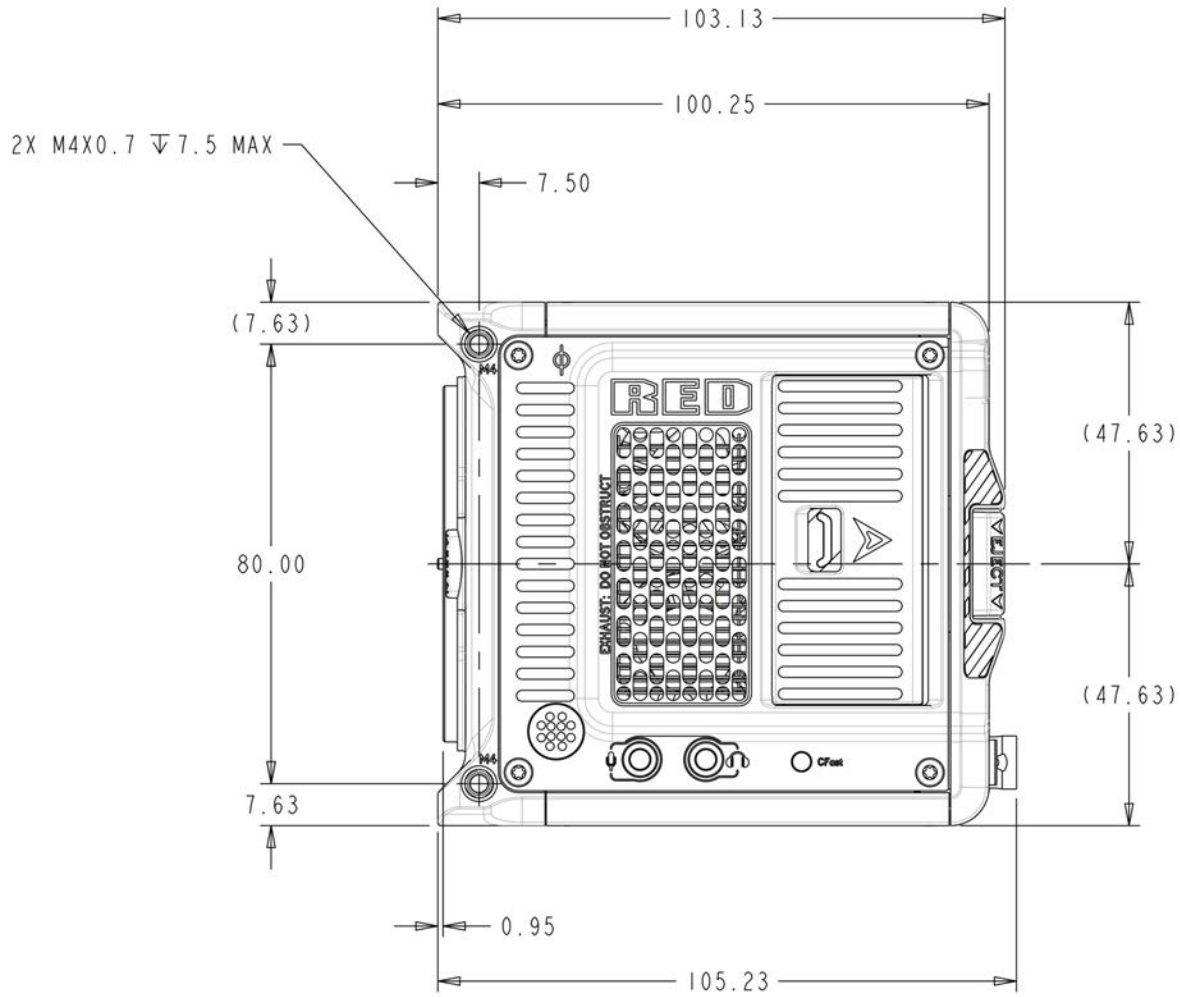

Figure: Camera Side View (Left)

### TOP VIEW

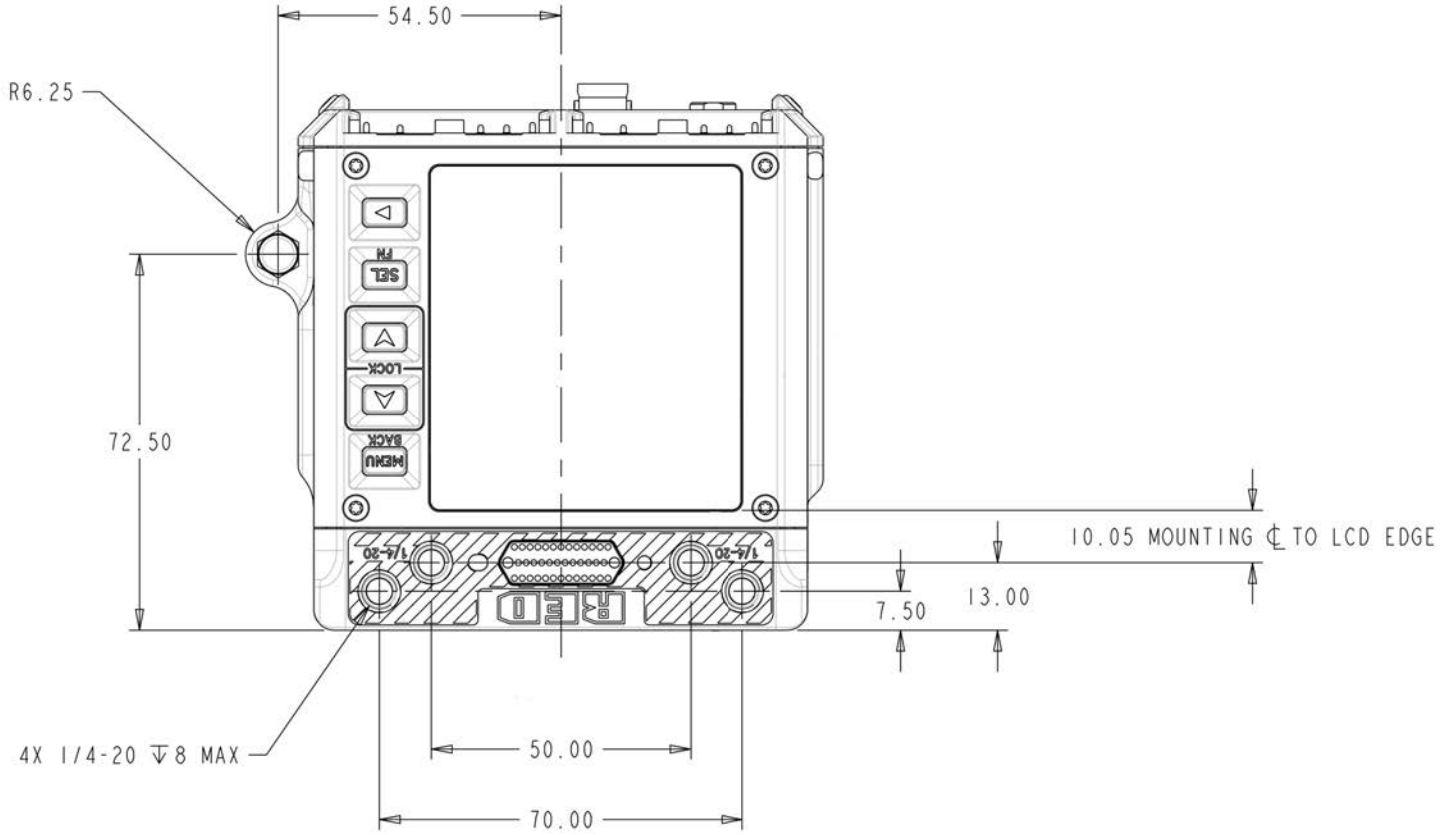

Figure: Camera Top View

### BOTTOM VIEW

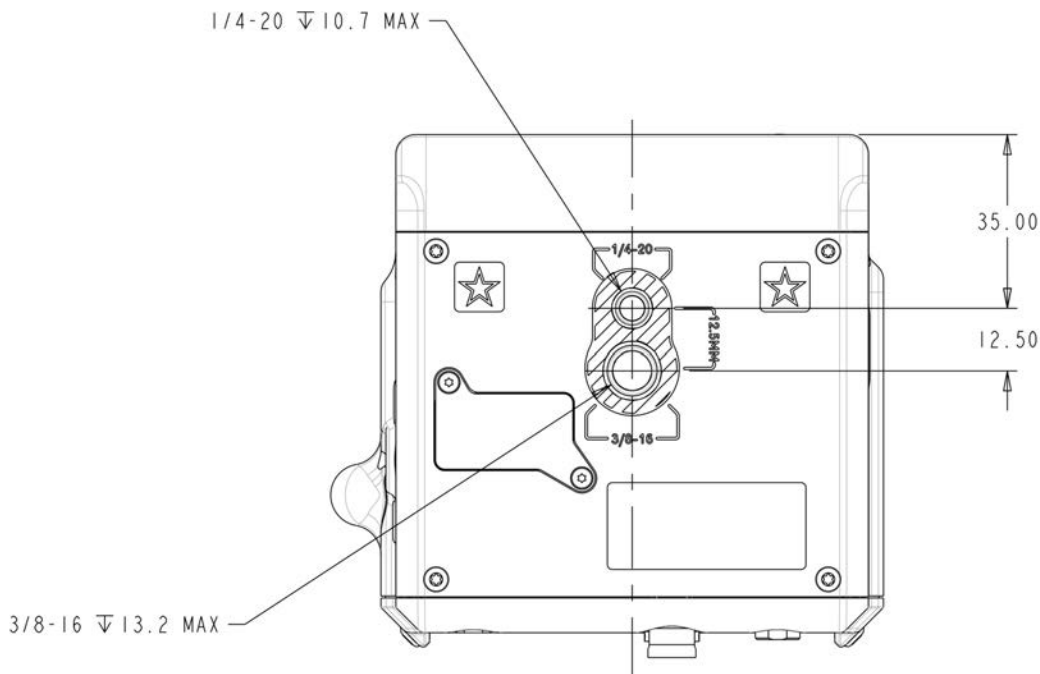

Figure: Camera Bottom View

## EXTENSION PORT

The Extension port is located on the back of the camera body.



The 9-pin 0B ODU Extension port supports RS-232 RX, RS-232 TX, and a General Purpose Input (GPI) trigger (active-low switch closure), General Purpose Output (GPO), Timecode, and Genlock. The connector also offers auxiliary 5 Volt power out, with a maximum sustained current draw of 500 mA.

To operate the GPI contact closure style trigger, short pin 6 (GPI) to pin 9 (ground).

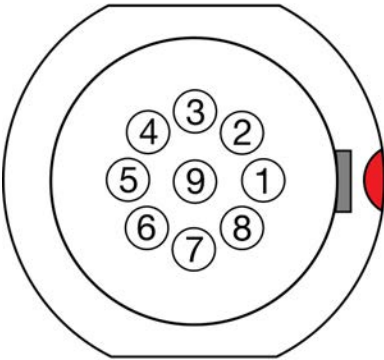

Figure: Front Face of the Extension port (Looking at the Camera)

**NOTE:** The required mating connector is 9-pin 0L Straight Plug Connector (ODU, part# SX0L0X-P09MCC0-0001).

### 9-PIN 0B ODU AUXILIARY PORT PINOUT

PIN	SIGNAL	DESCRIPTION
1	5 V AUX	5 Volt AUX (500 mA Max) enabled using the <b>Power</b> menu
2	Timecode Out	Timecode Out – SMPTE 12M <sup>1</sup>
3	GPO	General Purpose Out, Tally or Sync, 3.3 Volt Logic Level <sup>1</sup>
4	UART TX	RS-232 Transmit
5	UART RX	RS-232 Receive
6	GPI	General Purpose In, 3.3 Volt Logic Level <sup>2</sup>
7	Timecode In	Timecode In – SMPTE 12M
8	Genlock	Tri-Level Genlock In (SMPTE 296M and 274M)
9	GND	Signal and Power Ground

1. Not currently supported.

2. The signal path includes a resistor pulling the signal high, which is designed to work with a closure switch connected to GND.

## DC-INPUT

The DC-IN port is located on the back of the camera body.



Connect the 2-pin 0B ODU DC power Adaptor plug to this port to provide the camera with continuous DC power. The RED power Adaptor provides DC power to operate the camera and to recharge the attached Batteries.

**NOTE:** The camera cannot charge batteries while it is turned on.

## SPECIFICATIONS

The 2-pin 0B connector accepts unregulated (+) 7 to 17 Volts (V) Direct Current (DC) power.

The power consumption guidelines are:

- The camera uses between 20 Watts and 24 Watts of power in its basic configuration
- Additional power may be necessary based on ambient temperature and changes to camera firmware in future updates (up to an additional 5 Watts)
- Up to an additional 8 Watts might be required for additional accessories attached to the top pogo port and the EXT port
- Maximum power consumption is not expected to exceed 37 Watts

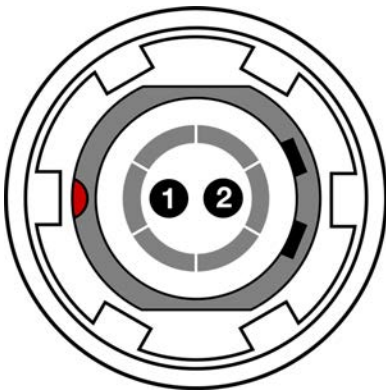

Figure: Front Face of DC-IN Port (looking at the back of the camera)

**NOTE:** The required mating connector is a 2-pin 0B Straight Plug Connector (ODU, part# SX0LCX-P02LJG0-0001).

## ODU 0B 2-PIN CONNECTOR

PIN	SIGNAL	DESCRIPTION	DIRECTION
1	7 to 17 Volts DC	Power to the camera and batteries	In
2	GROUND	Common ground	N/A

## CTRL (RS-232 CONTROL)

The CTRL port is located on the back of the [KOMODO Expander Module](#).



Connect to this port to provide communication between the camera and external devices.

## SPECIFICATIONS

The 4-pin 00B CTRL Connector supports RS-232 remote control for 3D camera communication and third-party metadata ingest applications.

The General Purpose Out (GPO) tally presents 3.3 V at a maximum of 0.04 A between pins 1 and 3. When used as a record tally, the rising edge of the pulse indicates the start of record, and the falling edge represents the end of record.

For more information about controlling the camera using RS-232, download the [RCP2 documentation](#).

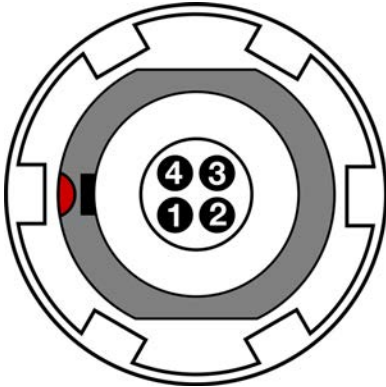
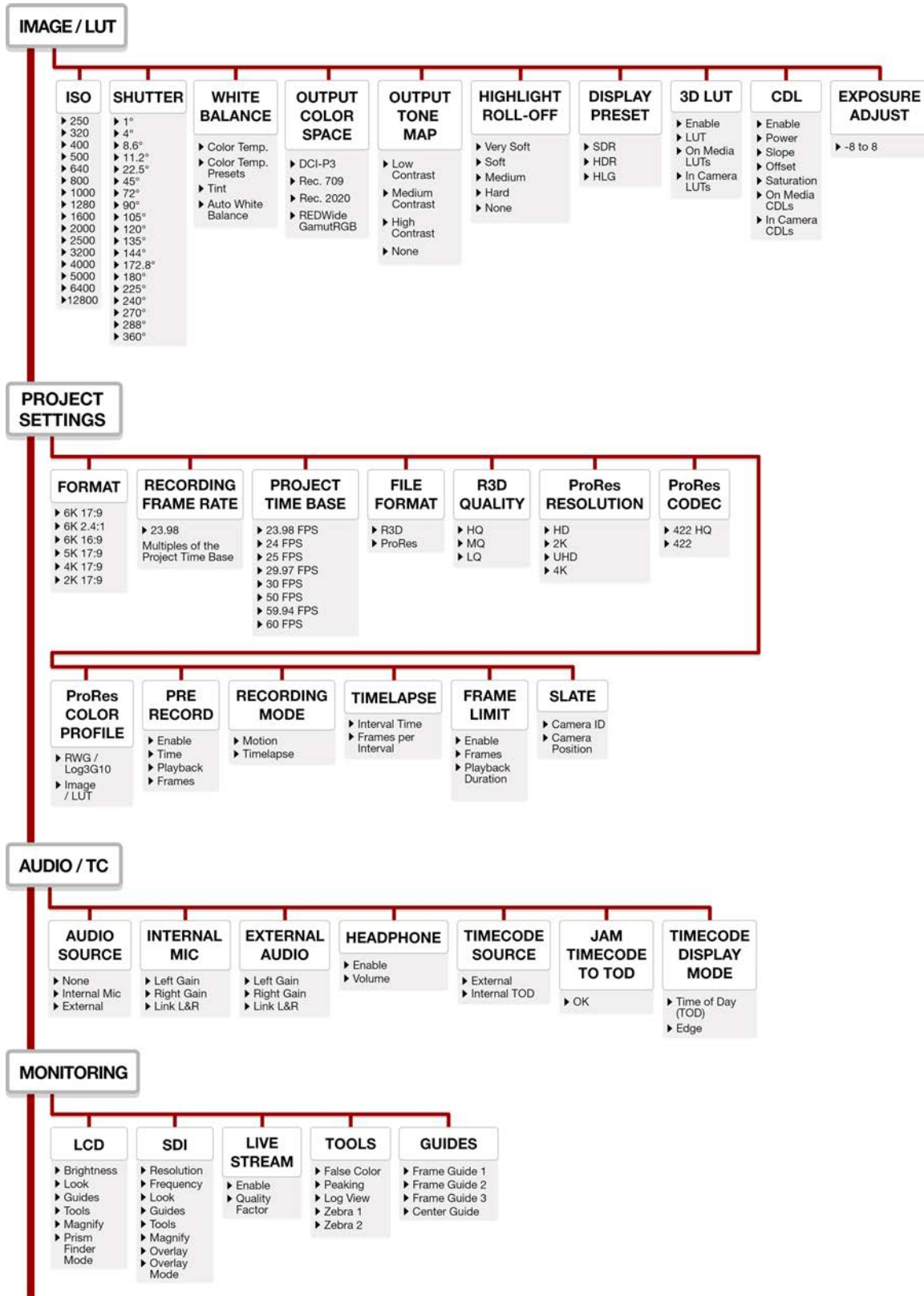

Figure: Front Face of CTRL Port (looking at the back of the [KOMODO Expander Module](#))

## ODU 00B 4-PIN CONNECTOR

PIN	SIGNAL	DESCRIPTION	DIRECTION
1	GROUND	Common ground	N/A
2	232 RX	RS-232 receive	In
3	SS/GPO	Shutter sync and general purpose output	Out
4	232 TX	RS-232 transmit	Out

# C. MENU MAP





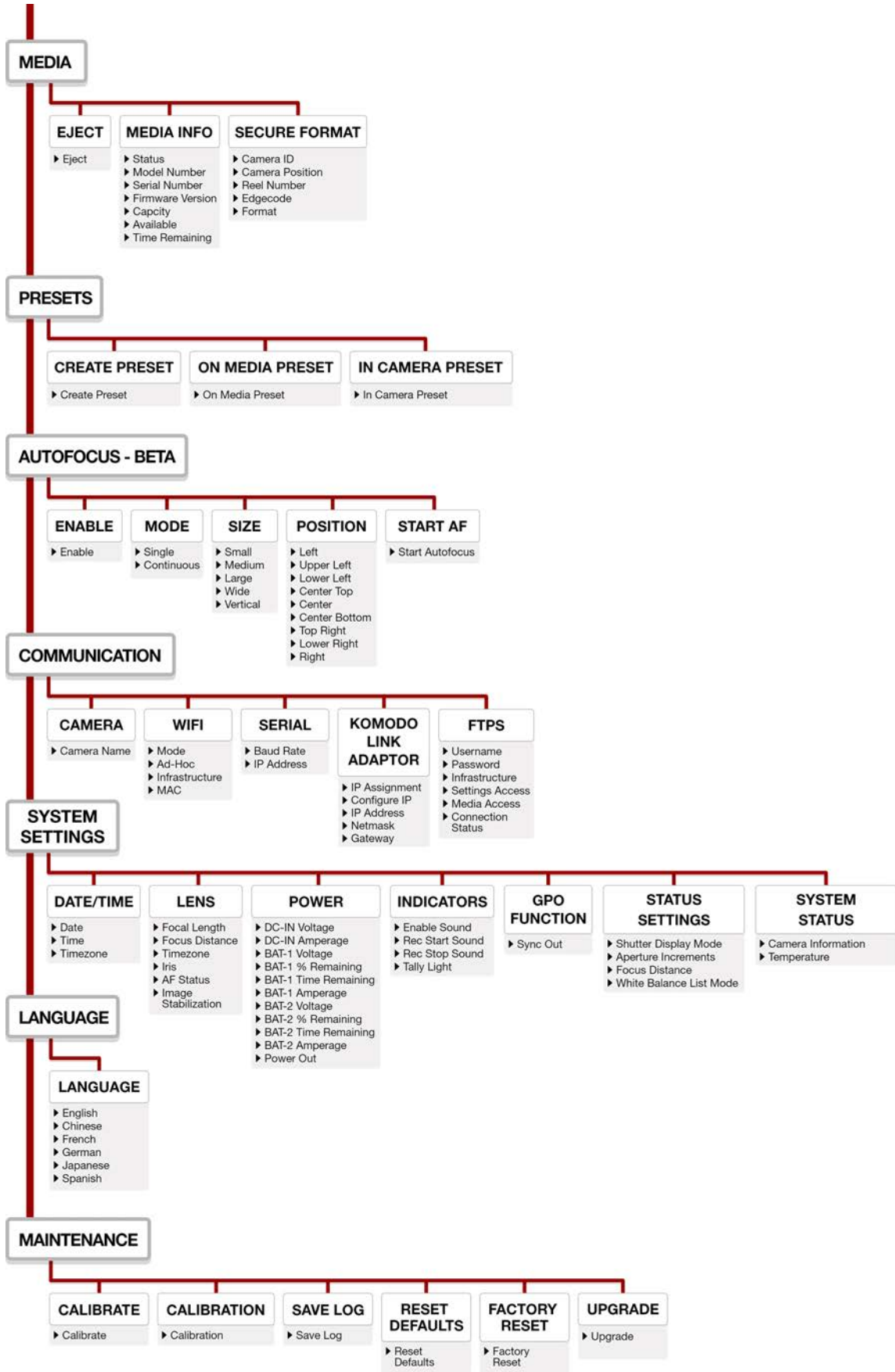

## D. TECHNICAL SPECIFICATIONS

Technical specifications reflect both current and projected information. Everything is subject to change.

### KOMODO® CAMERA

SPECIFICATION	DESCRIPTION
Sensor Type	KOMODO® 19.9 MP, Super 35 mm Global Shutter, CMOS
Effective Pixels	6144 x 3240
Sensor Size	27.03 mm × 14.26 mm (Diagonal: 30.56 mm)
Dynamic Range	16+ stops
Mount Type	RF mount with electronic communication Accepts Canon RF mount-based lens adapters for diverse lens choices Supports Canon EF with full electronic communication using compatible Canon RF mount adapters <sup>1</sup>
Max Data Rates	Up to 280 MB/s using RED Pro CFast or other qualified CFast 2.0 media cards <sup>1</sup>
REDCODE® RAW Maximum Frame Rates	40 FPS at 6K 17:9 (6144 × 3240) 50 FPS at 6K 2.4:1 (6144 × 2592) 48 FPS at 5K 17:9 (5120 × 2700) 60 FPS at 4K 17:9 (4096 × 2160) 120 FPS at 2K 17:9 (2048 × 1080)
Playback Frame Rates (Project Time Base)	23.98, 24, 25, 29.97, 30, 50, 59.94, and 60 FPS, at all resolutions
Best Available REDCODE® Settings	REDCODE HQ, MQ, and LQ at 6K 17:9 (6144 × 3240) up to 40 FPS REDCODE HQ, MQ, and LQ at 4K 17:9 (4096 × 2160) up to 60 FPS REDCODE HQ, MQ, and LQ at 2K 17:9 (2048 × 1080) up to 120 FPS
REDCODE® RAW Acquisition Formats	6K 17:9 (6144 × 3240), 2:1, 2.4:1, 16:9, and anamorphic 2x, 1.8x, 1.6x, 1.5x, 1.3x, 1.25x 5K 17:9 (5120 × 2700) 4K 17:9 (4096 × 2160) and 16:9 2K 17:9 (2048 × 1080)
Apple® ProRes	4K (4096 × 2160) at ProRes 422 HQ and ProRes 422 up to 60 fps 2K (2048 × 1080) at ProRes 422 HQ and ProRes 422 up to 120 fps
Construction	Aluminum Alloy
Weight	2.10 lb without the body cap and the CFast 2.0 media card
Battery Type	Two slots for REDVOLT BP batteries
DC Power	+7 to +17 V DC using the integrated 2-pin DC-Input port
Operating Temperature	0° C to 40° C (32° F to 104° F)
Storage Temperature	-20° C to 50° C (-4° F to 122° F)
Relative Humidity	0% to 85% non-condensing
Color Management	Image Processing Pipeline 2 (IPP2) Supports 33×33×33 3D LUTs Supports import of CDLs
Audio	Integrated dual channel digital mono microphones, uncompressed, 24-bit 48 kHz Additional dual channel by using the integrated 3.5 mm audio jack, uncompressed, 24-bit 48 kHz

## KOMODO® CAMERA

SPECIFICATION	DESCRIPTION
Autofocus	Contrast and Phase Detect
Remote Control	Wi-Fi for camera control and media access through an interchangeable dual band (2.4 GHz or 5 GHz) antenna mounted to a female RP-SMA connector. <sup>2</sup> Genlock, Timecode In, GPIO and Ctrl (RS-232) using the integrated 9-pin EXT Port. Wired camera control and media access through the KOMODO Link Adaptor, using USB-C or Gigabit Ethernet (compatible USB-C to Ethernet adapter <sup>1</sup> required) allowing camera control and live MJPEG preview video feed <sup>2</sup>
Monitor Outputs	Integrated 12G-SDI with 6G-SDI, 3G-SDI, and 1.5G-SDI modes with 10-bit 4:2:2 bit depth 12G-SDI: Up to 4096 × 2160 4:2:2 for 60p 6G-SDI: Up to 4096 × 2160 4:2:2 for 30p 3G-SDI: Up to 2048 × 1080 4:2:2 for 60p 1.5G-SDI: Up to 2048 × 1080 4:2:2 for 30p and 24p SMPTE Timecode, HANC Metadata, and 24-bit 48 kHz Audio
Monitor Options	Integrated 2.9" 1440 x 1440 touchscreen LCD with preview and camera control Wireless live preview video feed through 2.4 GHz or 5 GHz Wi-Fi for framing

## SOFTWARE

RED Control App	Access full camera controls and live preview from Android and iOS devices. Available from the Apple App Store and Google Play Store. RED Control works wirelessly or wired over USB-C, using the KOMODO Link Adaptor (sold separately)
-----------------	--

1. For more information on approved mount adaptors, lenses, batteries, accessories and CFast 2.0 cards, refer to [RED Third-Party Accessories](#)
2. Secure media and file access over FTPS requires camera firmware 1.5.0 or higher